

MSGROUP

MARQUES DOS SANTOS

www.msgroup.pt

work hard

24
25

NOVIDADES E PROMOÇÕES

MEGA

GC

KING TONY

Enjoy your work

IREGA

tejaña

CASCOS

FORZA

MECLUBE

Krafft

LIV

Kränzle

ELSEA
MADE IN ITALY

STANLEY

RIDGID

PFERD

ADVANCE

RUKO

TERRAX
by RUKO

SOMTA

LENOX

EUROBOOR
FOR PROFESSIONALS BY PROFESSIONALS

femi

LA PADANA
AIR COMPRESSORS

LORCH

SOLTER

MURTRA

Tiger

KITO

LISTA

KOCEL

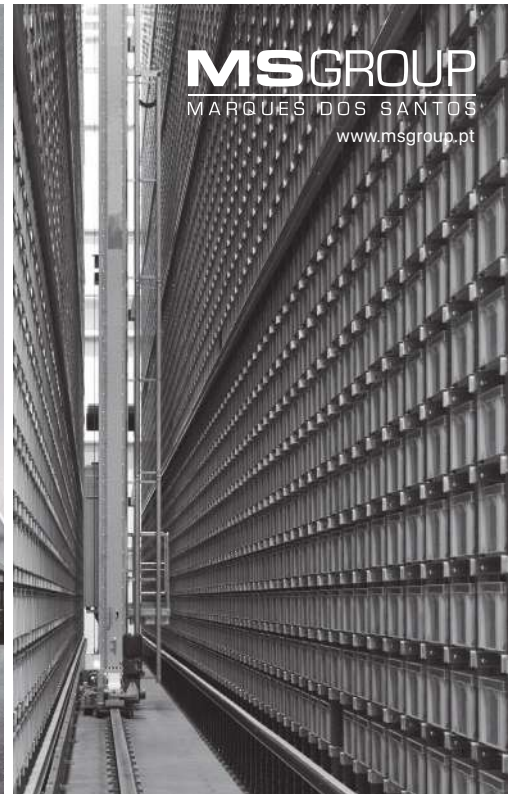

QUEM SOMOS

Somos especialistas na distribuição de máquinas, equipamentos e acessórios industriais com mais de 50 anos de experiência. O nosso catálogo tem mais de 500.000 referências, que inclui produtos em áreas tão distintas como Sistemas de Fixação, Produtos Químicos para Construção e Indústria, Equipamento de Proteção Individual, Equipamentos e Consumíveis de Soldadura, Ferramenta de Corte, Ferramentas Elétricas e Manuais, Equipamentos para Oficinas, Ar Comprimido, etc.

O nosso Centro de Distribuição, com sede em Aveiro, está completamente automatizado e equipado com a mais moderna tecnologia. Com uma capacidade de 300.000 m³ de armazenamento e uma operação logística contínua 24/6 (24 horas, 6 dias por semana), providencia assim um serviço de excelência a todos os clientes.

VALORES



AMBIÇÃO



INOVAÇÃO



QUALIDADE



ORIENTADO AO MERCADO



SUSTENTABILIDADE

NÚMEROS

+40

PAÍSES

+300

COLABORADORES

+500.000

REFERÊNCIAS

300.000 M³

ARMAZENAGEM

4



12



14



19



20



21



22



40



42



44



59



64



66



73



77



78



110



120



131



132



135



141



146



148



150



181



182



183



184



187



Equipamento Hidráulico para Oficina

RESISTÊNCIA E DURABILIDADE

© PARA MAIS INFORMAÇÕES TÉCNICAS CONTACTE O NOSSO SERVIÇO DE APOIO AO CLIENTE.



N15-2B

N15-2

MACACOS HIDROPNEUMÁTICOS PARA VEÍCULOS PESADOS

SAP	Capacidade Elevação	Altura (min-máx)	Peso	Preço
NP15-2B	15-30 Ton	150-300 mm	31 kg	€ 1571. ⁰⁰
N15-2B	15-30 Ton	150-300 mm	43.5 kg	€ 1571. ⁰⁰
N15-2	15-30 Ton	185-370 mm	46.5 kg	€ 1629. ⁰⁰
N15-4	80-50-30-15 Ton	155-390 mm	70.5 kg	€ 2952. ⁰⁰
N20-3	20-35-65 Ton	180-415 mm	69.5 kg	€ 2810. ⁰⁰
N25	25 Ton	215-323 mm	47 kg	€ 1610. ⁰⁰

© Para mais informações técnicas contacte o nosso serviço de apoio ao cliente.

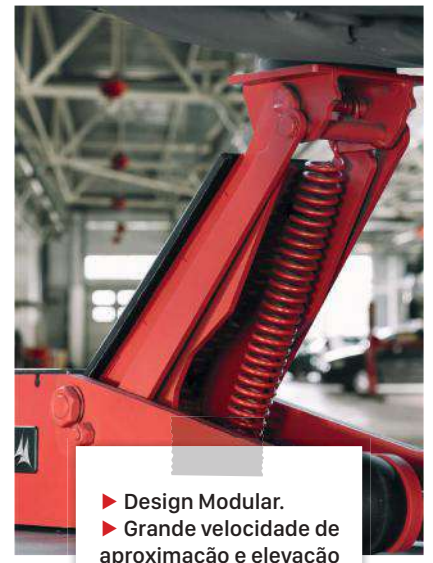

- ▶ Design Modular.
- ▶ Grande velocidade de aproximação e elevação de carga eficaz.
- ▶ Fabricados em aço da mais alta qualidade.
- ▶ Reforçado com tratamento anticorrosão e antigripagem por nitruração em banho de sal confere aos macacos propriedades de resistência e durabilidade excepcionais.



MACACOS DE GARAGEM

SAP	Capacidade Elevação	Altura (min-máx)	Comprimento Chassis	Peso	Preço
GT2	2 Ton	95-470 mm	850 mm	35 kg	€ 371.00
GT2X	2 Ton	70-450 mm	850 mm	39 kg	€ 467.00
GT3	3 Ton	95-470 mm	850 mm	36 kg	€ 429.00
GT4	4 Ton	140-530 mm	1075 mm	48,5 kg	€ 524.00

© Para mais informações técnicas contacte o nosso serviço de apoio ao cliente.



- ▶ Desenho robusto e resistente.
- ▶ Funcional e de fácil utilização.
- ▶ Maior Segurança.
- ▶ Pega Ergonómica.
- ▶ Rodas em poliamida.



GT2X
PERFIL BAIXO

MACACOS DE GARAGEM PARA SERVIÇOS PESADOS

SAP	Capacidade Elevação	Altura (min-máx)	Comprimento Chassis	Peso	Preço
T6	6 Ton	170-580 mm	1250 mm	81 kg	€ 733.00
T10	10 Ton	170-605 mm	1535 mm	120.5 kg	€ 943.00
T15	15 Ton	195-600 mm	1575 mm	145 kg	€ 1514.00
T20	20 Ton	200-615 mm	1585 mm	234.5 kg	€ 2124.00

© Para mais informações técnicas contacte o nosso serviço de apoio ao cliente.



BUREAU
VERITAS
EN 1494



- ▶ Adequado para todos os tipos de veículos, desde utilitários até industriais.
- ▶ Indispensável na garagem de uma frota de autocarros, camiões ou máquinas agrícolas.
- ▶ Os modelos maiores possuem rodas grandes localizadas no centro do chassis para maior melhor manuseio.

pedal de aproximação rápido para carregar



T6



T10



T15



T20

modelos de grande tonelagem tem rodas de aço

fuso de aproximação rápida

pega de transporte ergonómica (a partir de 20ton)



alavanca telescópica



- ▶ Macacos hidráulicos de aplicação universal para elevação ou movimentação de cargas.
- ▶ Sólidos, compactos e fiáveis.
- ▶ Garfo de aperto.

MACACOS DE GARRAFA

SAP	Capacidade Elevação	Altura	Elevação	Dimensões base	Peso	Preço
BR3	3 Ton	168 mm	105+65 mm	116x75 mm	3.7 kg	€ 90.00
BR5	5 Ton	212 mm	150+75 mm	125x75 mm	4.5 kg	€ 99.00
BR10	10 Ton	219 mm	150+75 mm	144x90 mm	6.4 kg	€ 131.00
BR15	15 Ton	228 mm	150+75 mm	164x110 mm	8.8 kg	€ 141.00
BR20	20 Ton	234 mm	150+75 mm	144x90 mm	10.6 kg	€ 152.00
BR30	30 Ton	242 mm	150+75 mm	196x144 mm	15.5 kg	€ 174.00
BR40	40 Ton	246 mm	150 mm	214x165 mm	23.5 kg	€ 246.00
BR50	50 Ton	260 mm	140 mm	214x165 mm	28 kg	€ 333.00

© Para mais informações técnicas contacte o nosso serviço de apoio ao cliente.

**MGD-100
MACACO DE GARRAFA 100 TON**
Altura min:160mm. Base: 375x375 mm.
Peso: 86 kg.

- ▶ Para trabalhos de alto desempenho.
- ▶ Equipado com manómetro e duas bombas (aproximação e operação).
- ▶ Comprimento adequado para esforço de bombeamento moderado.

limitador de accionamento hidráulico e válvula de segurança

com pega de transporte

manutenção rápida e fácil



€ 1610.00

**BRS10
MACACO DE GARRAFA BAIXO PERFIL 10 TON**
Altura: 131 mm. Elevação: 62+30 mm.
Peso: 5 kg.

€ 162.00 uso vertical e horizontal

alavanca telescópica zincada



**BRS20
MACACO DE GARRAFA BAIXO PERFIL 20 TON**
Altura: 190mm. Elevação: 105+55 mm.
Peso: 9.5 kg.

€ 200.00

**BRB20
MACACO HIDROPNEUMÁTICO DE GARRAFA 20 TON**
Altura min: 234 mm. Elevação: 138+75 mm. Peso: 16 kg.

€ 410.00

bomba pneumática

pega de transporte

acionamento misto, manual e pneumático



entrada de ar com controlo de direcção

€ 505.00



BUREAU
VERITAS

EN 1494



pega ergonómica

**TRS300
MACACO DE FOSSO
300 KG**
Altura mín: 1140 mm.
Elevação: 850 mm.
Peso: 26 kg.

€400.00

- ▶ Maior capacidade de carga.
- ▶ Certificados de conformidade com EN1494.
- ▶ Controlo de descida de carga LCS®.

**TRS750
MACACO DE FOSSO
750 KG**
Altura mín: 1110 mm.
Elevação: 820 mm.
Peso: 34 kg.

€448.00

pedal de elevação 45°

taco de espuma dura integrado

caixa porta-objetos

**TRS1200
MACACO DE FOSSO
1200 KG**
Altura mín: 1110 mm.
Elevação: 815mm.
Peso: 36 kg.

€524.00

base com elevação mínima para maior estabilidade

MEGA



**ME-1500
MESA ELEVATÓRIA 1500 KG**
Mesa: 500x1020 mm
Altura Mín/Máx: 210/880mm
Peso: 135 kg

€1514.00



**ME-2500
MESA ELEVATÓRIA 2500 KG**
Mesa: 540x1060 mm
Altura Mín/Máx: 300/880mm
Peso: 190 kg

€1857.00

- ▶ Mecanismo de segurança contra acionamento involuntário e LCS®.
- ▶ Pega em "T". Punho de borracha.
- ▶ Rodas de poliamida para uma melhor manobragem.
- ▶ Pernos de segurança para utilizar diferentes alturas.



© Para mais informações técnicas contacte o nosso serviço de apoio ao cliente. Fotografias meramente ilustrativas.

**PRS15
PRENSA DE BANCADA 15 TON**

Altura Total: 800 mm.
Espaço entre colunas: 430 mm.
Espaço pistão-mesa mín-máx: 45-338 mm.
Largura x profundidade pés: 550x350 mm.
Peso: 48 kg.

€ 714.⁰⁰



PRS15

*mandris
opcionais*



**PRB30
PRENSA HIDRÁULICA COMPACTA ECO 30 TON**

Altura Total: 1850 mm.
Espaço entre colunas: 530 mm.
Espaço pistão-mesa mín-máx: 53-7410 mm.
Peso: 104 kg.

€ 981.⁰⁰

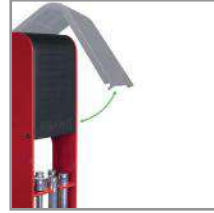

PRB30

*proteção
contra
pecinas*

*calços
nevensweis*

*bandeja
inferior*

**PRC30 / PRC30NF
PRENSA HIDRÁULICA
MODELO COMPACTO 30 TON**

Altura Total: 1850 mm.
Espaço pistão-mesa mín-máx: 17-854 mm.
Espaço entre colunas: 530 mm.
Peso: 112 kg.



PRC30

*manómetro
integrado*

*mandris
opcionais*

*pernos
com
botão*

*bandeja
inferior*

*calços
nevensweis*

*bomba dupla
de aproximação
e trabalho*



Os modelos NF são acciona-
dos por ar, utilizando o pedal.

PRC30
€ 1324.⁰⁰

PRC30NF
€ 1571.⁰⁰

**PRD50 / PRD50NF
PRENSA HIDRÁULICA
ESTRUTURA LARGA 50 TON**

Altura Total: 1900 mm.
Espaço pistão-mesa mín-máx: 84-770 mm.
Espaço entre colunas: 720 mm.
Peso: 191 kg.

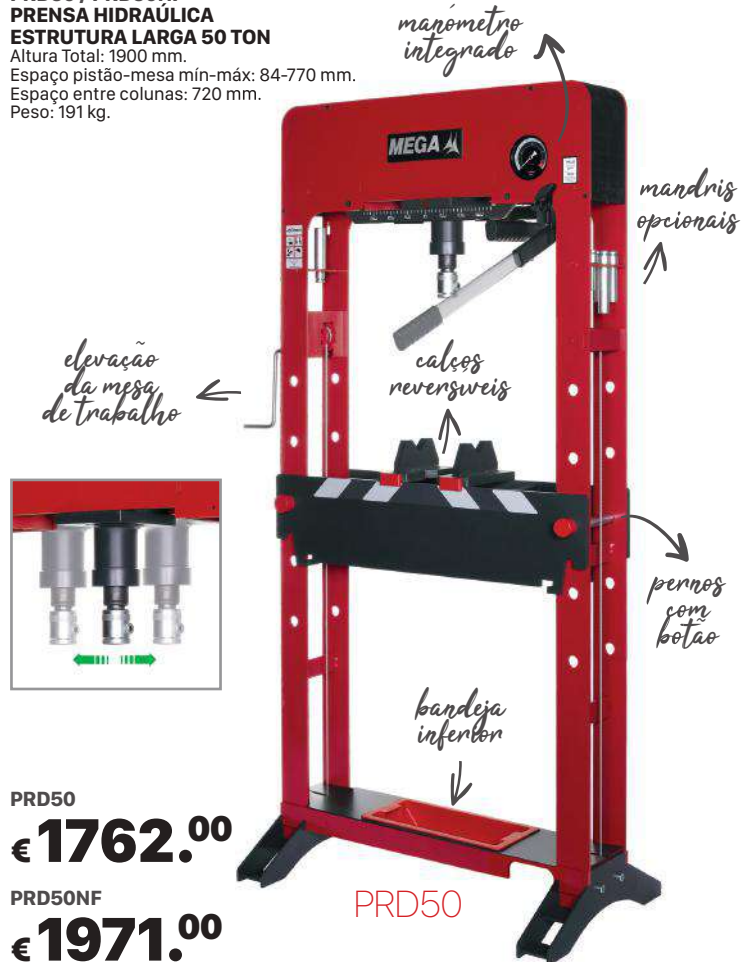

PRD50

*manómetro
integrado*

*mandris
opcionais*

*pernos
com
botão*

*bandeja
inferior*

*calços
nevensweis*

*elevação
da mesa
de trabalho*



PRD50
€ 1762.⁰⁰

PRD50NF
€ 1971.⁰⁰

PRP50
PRENSA HIDRÁULICA CHASSI LARGO 50 TON
 Altura Total: 1920mm.
 Espaço entre colunas: 720 mm.
 Espaço pistão-mesa mín-máx: 80-465 mm.
 Peso: 225 kg.

€ **2429.00**

► Os novos modelos de chassi largo PRP completam a mais ampla linha de prensas de oficina automóvel e de manutenção.
 ► Graças as suas funcionalidades exclusivas destacam-se claramente entre outras prensas do mercado.

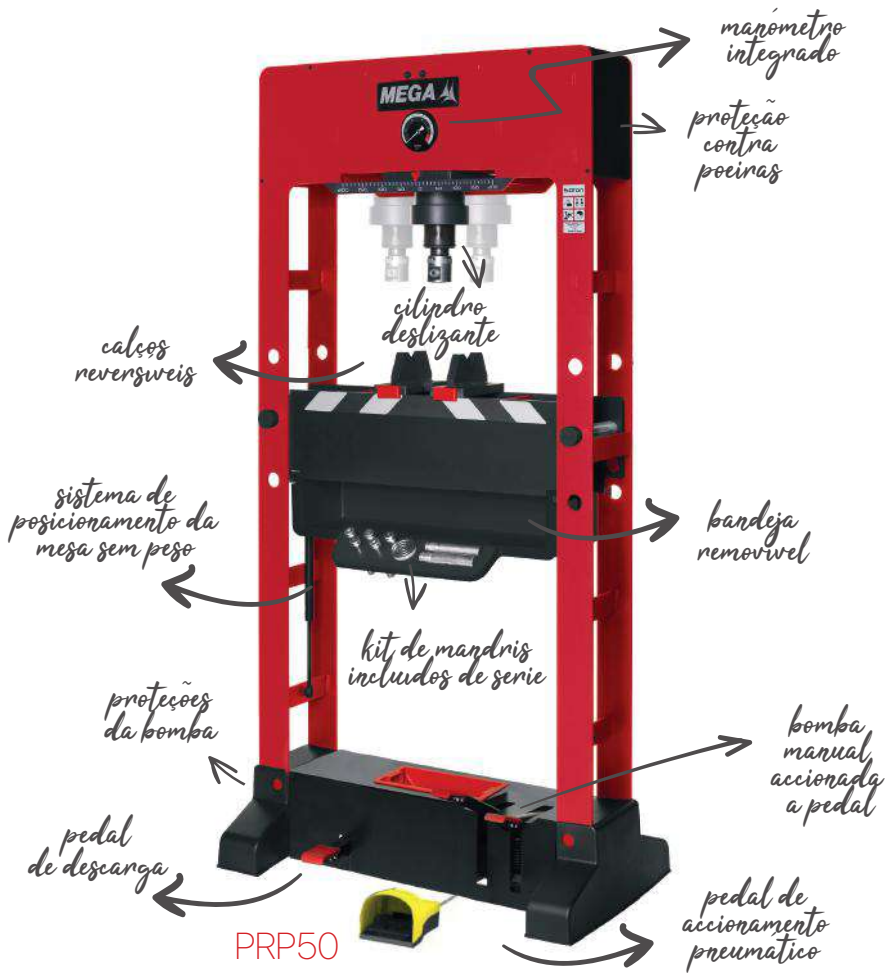

K100E
PRENSA HIDRÁULICA ELÉTRICA CHASSI LARGO 100 TON
 Altura Total: 2050 mm.
 Espaço entre colunas: 975 mm.
 Espaço pistão-mesa mín-máx: 53-7410 mm.
 Peso: 104 kg.

€ **8762.00**



K100
PRENSA HIDRÁULICA CHASSI LARGO 100 TON
 Altura Total: 2050 mm.
 Espaço entre colunas: 975 mm.
 Espaço pistão-mesa mín-máx: 53-7410 mm.
 Peso: 620 kg.

€ **6381.00**



**GC-10
ESTICADOR DE CHAPEIRO**

Cilindro: 10T. Corrente: 1000Kg.
Peso: 45 kg.



*conjunto de 25 peças
em caixa plastica*

€ **695.00**

**DR2/ DR3
CURVADORAS DE TUBO**

Tubos 2"/3" e canalização DIN 2440 e
DIN2441. Ângulos até 180°. Tripé e
alavanca telescópica.

DR2
€ **752.00**

DR3
€ **1095.00**



Inclui os seguintes conjuntos de formas:
DR2: 1/2" - 3/4" - 1" - 1 1/4" - 1 1/2" - 2"
DR3: 1/2" - 3/4" - 1" - 1 1/4" - 1 1/2" - 2" - 2 1/2" - 3"



**EHA-10
ESTICADOR DE CARROÇARIA**

12 peças. Cilindro 10T. Corrente 1400kg.
Bomba manual. Peso 178.5 kg.

1. BM-04
2. CC-10B
3. A-5541
4. A-5096
5. A-5095
6. A-5094
7. S-21
8. A-5087
9. A-1512
10. A-1513
11. A-5088
12. A-5089



- ▶ Para reparação precisa de carroçarias gravemente danificadas.
- ▶ A posição de balanço do braço permite realizar trabalhos na diagonal.
- ▶ Válvula de segurança de sobrecarga.
- ▶ Limitador de curso hidráulico.

€ **2381.00**

**CC-10B
CILINDRO HIDRÁULICO 10 TON**

Curso: 135 mm. Volume: 196 cm³.
Peso: 4.35 kg



€ **187.00**

**BDD-5
BOMBA ELÉTRICA DUPLO EFEITO**

Capacidade: 5000 cm³.
Pressão de trabalho: 700 bar. Peso: 36 kg.



€ **3333.00**

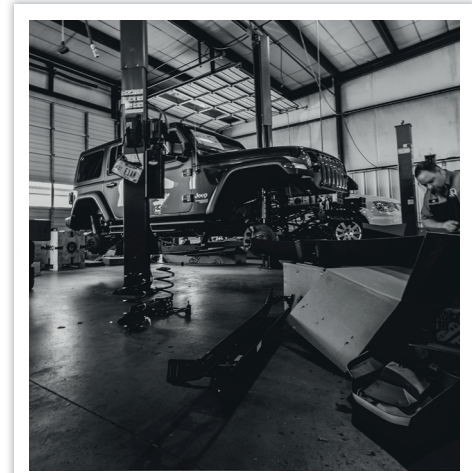

BOMBA HIDRÁULICA MANUAL EFEITO SIMPLES

SAP	Tipo	Capacidade útil	Pressão de trabalho	Peso	Preço
BM-04	1 velocidade	400 cm ³	10000 psi	4.25 kg	€ 162. ⁰⁰
BM-1	1 velocidade	1250 cm ³	10000 psi	6.7 kg	€ 238. ⁰⁰
BM-2	1 velocidade	2000 cm ³	10000 psi	12 kg	€ 295. ⁰⁰
BM-3	2 velocidades	3000 cm ³	10000 psi	14 kg	€ 676. ⁰⁰
BM-6	2 velocidades	6000 cm ³	10000 psi	20 kg	€ 790. ⁰⁰

© Para mais informações técnicas contacte o nosso serviço de apoio ao cliente.

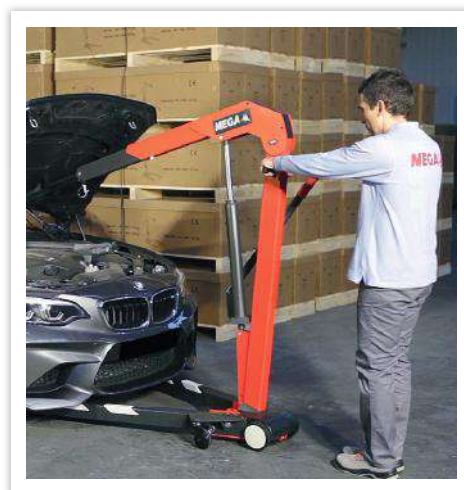

- ▶ Braço telescópico com peça de fixação.
- ▶ Indicador da carga máxima na operação da extensão do braço.
- ▶ Com controlo de descida LCS®, e velocidade variável de descida.
- ▶ Dobráveis, garfos flutuantes que permitem o rápido posicionamento perante a carga, assim como o seu manuseamento.



GRUAS DE OFICINA

SAP	Capacidade	Larg. rodas dianteiras	Alcance (min-máx)	Alt. Horizontal	Peso	Preço
CRP10	1000 kg	860 mm	960-1300 mm	1580 mm	99 kg	€ 1019. ⁰⁰
CRP20	2000 kg	1080 mm	1200-1610 mm	1740 mm	150 kg	€ 1419. ⁰⁰
CRV10	1000 kg	970 mm	960-1300 mm	1580 mm	85 kg	€ 981. ⁰⁰
CRV20	2000 kg	1080 mm	1200-1610 mm	1740 mm	143 kg	€ 1419. ⁰⁰

© Para mais informações técnicas contacte o nosso serviço de apoio ao cliente.

Equipamentos e acessórios hidráulicos



① PARA MAIS INFORMAÇÕES TÉCNICAS CONTACTE O NOSSO SERVIÇO DE APOIO AO CLIENTE.



- ▶ Concebidos para ser utilizados em qualquer posição.
- ▶ O rolamento em latão absorve a carga descentrada e reduz o desgaste do cilindro.
- ▶ Todas as peças dos cilindros são construídas com materiais de liga de aço de alta resistência.
- ▶ Equipados com raspador no pistão para reduzir a infiltração de sujidade e prolongar a vida útil do cilindro.

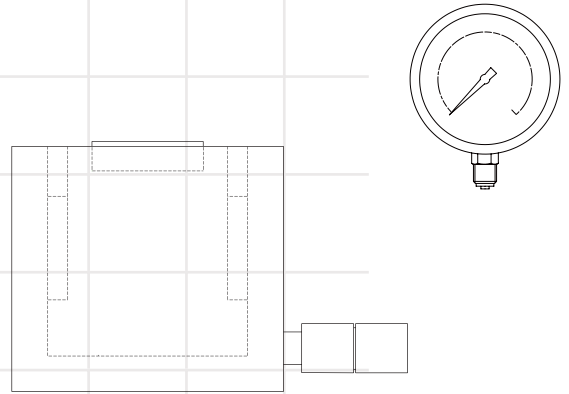
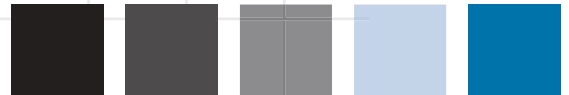

1. CILINDRO DE SIMPLES EFEITO SÉRIE R

GCHR01105
11.1 Toneladas.
Curso 50 mm.
Alt. 144 mm.
Capacidade 80 cm³.
€ 410.62

GCHR03015
30.9 Toneladas.
Curso 150 mm.
Alt. 444 mm.
Capacidade 663 cm³.
€ 1075.35

2. CILINDRO DE SIMPLES EFEITO ALTA TONELAGEM - SÉRIE G

GCHG02305
23.2 Toneladas.
Curso 50 mm.
Alt. 174 mm.
Capacidade 166 cm³.
€ 418.19

3. CILINDRO DE SIMPLES EFEITO SÉRIE BAIXA - L

GCHL02304
23.2 Toneladas.
Curso 41 mm.
Alt. 138 mm.
Capacidade 136 cm³.
€ 418.19

GCHR01115
11.1 Toneladas.
Curso 150 mm.
Alt. 394 mm.
Volume 239 cm³.
€ 517.48

GCHR05505
55 Toneladas.
Curso 50 mm.
Alt. 219 mm.
Capacidade 393 cm³.
€ 1235.22

GCHG03005
30.9 Toneladas.
Curso 50 mm.
Alt. 175 mm.
Volume 221 cm³.
€ 546.09



4.

4. CILINDRO SIMPLES EFEITO OCO - SÉRIE RH

GCHRH01204
12.6 Toneladas.
Curso 41 mm.
Alt. 186 mm.
Capacidade 74 cm³.
€ 512.43

GCHRH02005
20.2 Toneladas.
Curso 48 mm.
Alt. 220 mm.
Volume 139 cm³.
€ 862.46

GCHRH03006
28.9 Toneladas.
Curso 63 mm.
Alt. 263 mm.
Volume 260 cm³.
€ 1094.70



5.

5. CILINDRO SIMPLES EFEITO EXTRA BAIXO - SÉRIE S

GCHS01111
11.1 Toneladas.
Curso 11 mm.
Alt. 56,5 mm.
Capacidade 17 cm³.
€ 414.82

GCHS03113
30.9 Toneladas.
Curso 13 mm.
Alt. 73 mm.
Volume 57 cm³.
€ 646.22



6.

6. BOMBA MANUAL DE SIMPLES EFEITO - SÉRIE BS

GCHBS106
600 cm³.
700 Bar.
6.5 Kg.
€ 382.85

GCHBS112
1200 cm³.
700 Bar.
8.2 Kg.
€ 410.65



7.

7. MANGUEIRA/TUBO HIDRÁULICO - SÉRIE AMH

GCHAMH1115
1.5 m. 600 cm³.
3/8 NPT.
700 Bar.
6.5 Kg.
€ 78.25

GCHAMH1120
2m. 1200 cm³.
3/8 NPT.
700 Bar.
8.2 Kg.
€ 94.24



8.

8. ACESSÓRIOS ENCAIXE RÁPIDO

GCHAEM0700
Macho.
1.6 L/min.
700 Bar.
€ 21.04

GCHAEH0700
Fêmea.
1.6 L/min.
700 Bar.
€ 31.97



9.

9. DISTRIBUIDOR SÉRIE AAM

GCHAAM0701
A - 3/8 18 NPT.
B - 3/8 19 GAS.
Comprimento 135mm.
€ 58.90



10.

10. MANÓMETRO DE PRESSÃO

AM07
3/8" NPT.
0-700 bar
€ 94.24

Ferramentas e equipamento para oficina



KT87452C-B
CADEIRA DE TRABALHO
Capacidade carga 150 Kg. 2 gavetas. 50Kg.
350x260x240mm. Ferramentas não incluídas.



€ 50.00

rodízios
giratórios
360°

KT9TWP2-30A-B
DISTRIBUIDOR DE ÓLEO MANUAL
Capacidade 30 L. Mangueira Ø12x8 mm.
Comprimento da mangueira 130 mm.
13.5 Kg.



€ 178.57

KT9TVP1-65A-B / KT9TVP1-80A-B
EXTRATOR DE ÓLEO PNEUMÁTICO
Capacidade 65 L / 80 L. 1/4". 87-116 psi
Temperatura 19-60 °C. 25/29.7 kg.



65 LTS - KT9TVP1-65A-B

€ 291.43

80 LTS - KT9TVP1-80A-B

€ 457.14

KT9DEP316AA-B
TESTE INJECTORES 220V
Temperatura ambiente -10-38°C.
Poder ultrasónico 100W.
Volume do cilindro 120 ml.
Tempo de pulverização 0-10min. 21.5 kg.



€ 825.71

KT9TV21-09
EXTRATOR DE ÓLEO MANUAL
Capacidade 9 L. Temperatura 19-60 °C.
4.75 kg.



€ 107.14

KT9TV12-020
SANGRADOR DE TRAVÕES
Pneumático. Capacidade 2 L. 1/4".
2,75-11,5 Bar. Temperatura 19-60 °C.



€ 141.43

KT9TV14-020
SANGRADOR DE TRAVÕES
Pneumático. Capacidade 2 L. 1/4". 2,75-
11,5 Bar. Temperatura 19-60 °C.



€ 141.43

KT9TT21-03
APARADOR ÓLEO DO EIXO DA RODA
Capacidade 3 L. 246x316x156mm. 390 gr.



€ 8.57

MACACO GARRAFA - SERIE PROFESSIONAL
 3.5 - 5 - 10 - 15 - 20 Ton

SAP	Capacidade Elevação	Altura ajustável	Altura min	Altura máx.	Peso	PREÇO
KT9TY111-035A-B	3.5 Ton	88 mm	172 mm	372 mm	3.95 kg	€ 41.43
KT9TY111-05A-B	5 Ton	110 mm	218 mm	474 mm	5.05 kg	€ 48.57
KT9TY111-10A-B	10 Ton	115 mm	220 mm	488 mm	7.56 kg	€ 72.86
KT9TY111-15A-B	15 Ton	113 mm	228 mm	508 mm	10.12 kg	€ 88.57
KT9TY111-20A-B	20 Ton	110 mm	241 mm	525 mm	13.32 kg	€ 108.57



- ▶ Construção em soldadura precisa e estanque.
- ▶ Válvula de segurança evita danos no cilindro causados por abertura excessiva.
- ▶ Revestimento niquelado electrolítico para evitar ferrugem.
- ▶ Vedações duplas para evitar vazamento de óleo.

MACACO GARRAFA
 2/3/4/5/6/8/10/12/15/16/20/32/50 Ton

SAP	Capacidade Elevação	Altura ajustável	Altura min	Altura máx.	Peso	PREÇO
KT9TY112-02A-B	2 Ton	48 mm	175 mm	339 mm	2.46 kg	€ 20.00
KT9TY112-03A-B	3 Ton	60 mm	190 mm	368 mm	2.58 kg	€ 22.86
KT9TY112-04A-B	4 Ton	60 mm	190 mm	368 mm	2.58 kg	€ 24.29
KT9TY112-05A-B	5 Ton	70 mm	210 mm	407 mm	4.12 kg	€ 28.57
KT9TY112-06A-B	6 Ton	70 mm	210 mm	407 mm	4.12 kg	€ 31.43
KT9TY112-08A-B	8 Ton	80 mm	225 mm	440 mm	5.5 kg	€ 34.29
KT9TY112-10A-B	10 Ton	80 mm	225 mm	440 mm	5.5 kg	€ 37.14
KT9TY112-12A-B	12 Ton	80 mm	230 mm	465 mm	6.82 kg	€ 41.43
KT9TY112-15A-B	15 Ton	80 mm	230 mm	460 mm	8.03 kg	€ 47.14
KT9TY112-16A-B	16 Ton	80 mm	230 mm	460 mm	8.03 kg	€ 50.00
KT9TY112-20A-B	20 Ton	60 mm	240 mm	450 mm	10.22 kg	€ 54.29
KT9TY112-32A-B	32 Ton	-	260 mm	430 mm	18.05 kg	€ 98.57
KT9TY112-50A-B	50 Ton	-	280 mm	470 mm	26.1 kg	€ 141.43

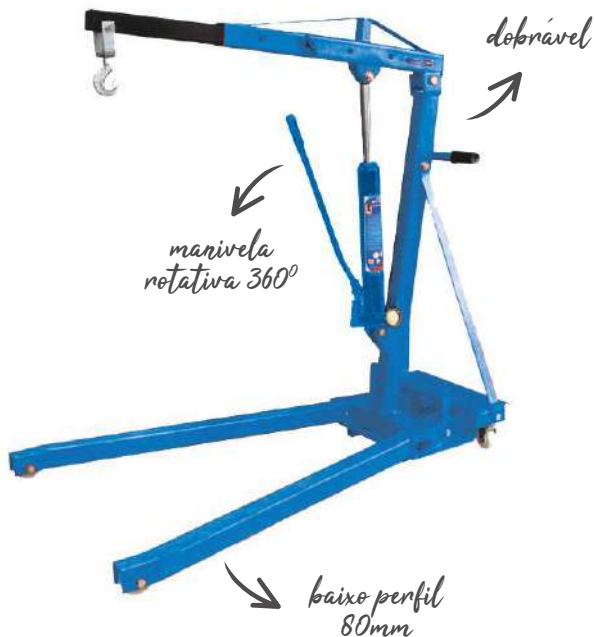
KT9TY1342-02A-B
GRUA 2T COM BRAÇO GIRATÓRIO 360°
 Capacidade 2 Ton. Elevação 25-2400 mm.
 1590x1100x1416 mm. 103.5 kg.

€ 485.⁷¹
KT9TY135-100A-B / KT9TY135-125A-B
CAVALETE SUPORTE DE MOTOR
 Capacidade 65 L / 80 L. 1/4". 87-116 psi
 Temperatura 19-60 °C. 25/29.7 kg.

453 KG - KT9TY135-100A-B

€ 92.⁸⁶

567 KG - KT9TY135-125A-B

€ 127.¹⁴

KT9TY133A-25A-B
MACACO DE RODAS BAIXO PERFIL
Capacidade 2.5 Ton. Alt. mín 85 mm.
Alt. máx. 375 mm. 14 kg.



€ **185.⁷¹**

KT9TY153-03A-B
MACACO RODAS ALUMÍNIO
Capacidade 3 Ton. Alt. mín 100 mm.
Alt. máx. 465 mm. 28.5 kg.



€ **207.¹⁴**

KT9TY131-05A-B / KT9TY131A-03A-B
MACACO RODAS LONGO
Capacidade 3/5 Ton. Alt. mín 130/150 mm.
Alt. máx. 600/570 mm. 71.5/100 kg.



3 TON - KT9TY131A-03A-B

€ **371.⁴³**

5 TON - KT9TY131-05A-B

€ **600.⁰⁰**

KT9TY1421-05A-B
MACACO TRANSMISSÕES
Capacidade 0.5 Ton. Alt. mín 1140 mm.
Alt. máx. 1965 mm. 35 kg.



€ **207.¹⁴**

KT9TY342-02A-B / KT9TY342-06A-B
CAVALETE CREMALHEIRA
2 unidades. Capacidade 2 / 6 Ton. Alt. mín 278/395 mm.
Alt. máx. 423/613 mm. 5.3/13.7 kg.



2 TON - KT9TY342-02A-B

€ **35.⁷¹**

6 TON - KT9TY342-06A-B

€ **122.⁸⁶**

KT9TY611-05A-B
APOIO DE MOTOR
Capacidade 0.5 Ton. Comprimento da viga 1500 mm. 17 kg.

*suporta facilmente o motor
ao remover a transmissão*



€ **107.¹⁴**

KTP2523MT-AM
JOGO DE CHAVES CAIXA 23 PCS 1/4"
6-13mm. Revestimento de titânio. 0.6 kg.



€ **41.⁴³**

KTP2523MT-AM
JOGO DE CHAVES CAIXA 24 PCS 1/2"
8-32mm.



€ **64.²⁹**

KTP93013MR
JOGO DE FERRAMENTA MULTIFUNÇÃO 61 PCS
Bolsa de transporte. Prático e versátil.



€ **121.⁴³**

KTP41542MRV
CAIXA DE FERRAMENTAS 42 PCS
470x203x238 mm. 6.2 kg.



€ **115.⁰⁰**

KT9G37-000MR01-G / KT9G37-000MR01
CARRO DE FERRAMENTAS COM 7 GAVETAS 173 PCS
Capacidade carga 420 kg. 770x450x970 mm. 47,5 kg.



● **KT9G37-000MR01-G**
€ 1071.43

● **KT9G37-000MR01**
€ 1071.43



KT9G37-149MRV-G / KT9G37-149MRV
CARRO DE FERRAMENTAS COM 7 GAVETAS 149 PCS
Capacidade de carga 400 kg. 770x450x970 mm. 58 kg.



● **KT9G37-149MRV-G**
€ 998.57

● **KT9G37-149MRV**
€ 998.57



KT87G37-7BA-G / KT87G37-7BA
CARRO PARA FERRAMENTAS COM 7 GAVETAS

Capacidade carga 420 kg. 770x450x970 mm. 47,5 kg.



● KT87G37-7BA-G
€ **582.⁸⁶**

● KT87G37-7BA
€ **582.⁸⁶**

- ▶ Fechos de gavetas magnéticos.
- ▶ Tampo de trabalho multifuncional.
- ▶ Sistema de bloqueio lateral.
- ▶ Rodízios TPR giratórios.
- ▶ Pára-choques TPR de proteção de canto.



**Conheça a marca
e as suas ferramentas,
solicite uma demonstração.**



Chaves Ajustáveis

MADE IN SPAIN

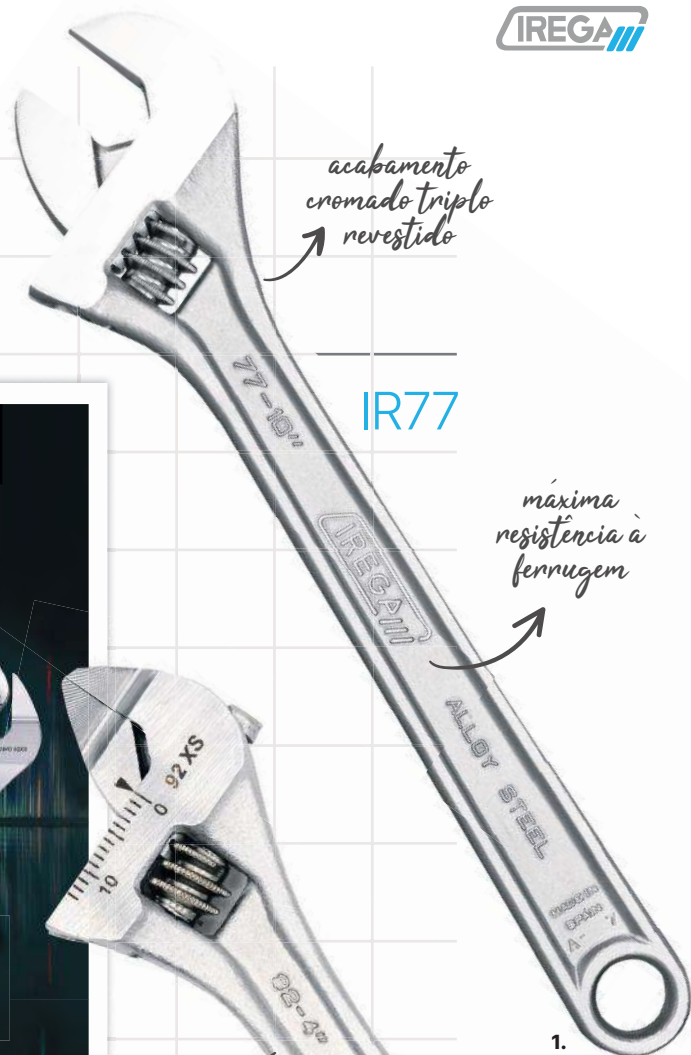

IR77

1.



IR92XS

2.



IRSW092

3.

ErgoTop
ULTIMATE GRIP

leve e compacta

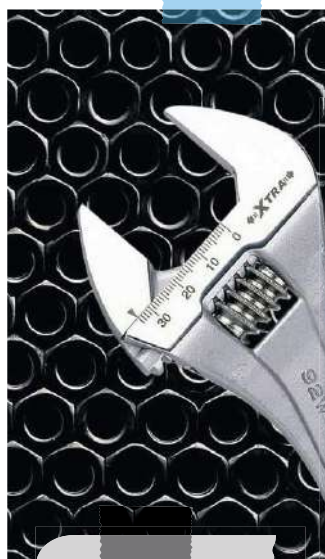

- ▶ Desempenho suave e preciso.
- ▶ Ajuste ideal.
- ▶ Leves, compactas e ergonómicas.
- ▶ Grande durabilidade.



1. CHAVES CRESCENTES

IR77-4 4" - 114 mm / Abertura 13mm	€ 10. ⁵⁴
IR77-6 6" - 160mm / Abertura: 19.20mm	€ 11. ³⁶
IR77-8 8" - 206mm / Abertura: 24.05mm	€ 15. ⁷¹
IR77-10 10" - 257mm / Abertura: 29mm	€ 19. ²⁹
IR77-12 12" - 308mm / Abertura 34mm	€ 25. ⁸⁹
IR77-15 15" - 385mm / Abertura 43.12mm	€ 41. ³⁶
IR77-18 18" - 461mm / Abertura 53mm	€ 65. ⁸¹
IR77-24 24" - 612mm / Abertura 62mm	€ 176. ⁵⁸



2. CHAVES CRESCENTES SLIM

IR92XS-4 4" - 115mm / Abertura: 13mm	€ 15. ⁰⁹
IR92WXS-6 6" - 161mm / Abertura: 24mm	€ 17. ²⁴

3. CHAVES CRESCENTES SWO

IRSW092-6 6" - 176mm / Abertura: 34mm	€ 27. ⁴⁴
IRSW092-8 8" - 216mm / Abertura: 39mm	€ 29. ⁵²

Suportes de máquinas industriais



- ▶ Tapetes Anti-vibração e Antiderrapantes.
- ▶ Amortecedores metálicos.
- ▶ Amortecedores de borracha.
- ▶ Blocos silenciosos.



APOIO ANTI-VIBRATÓRIO

Dureza 65 Shõre. Ø M8-M16.

000B Ø M8 - Base 40mm / 0-60 Kg	€ 2.88
00B Ø M10 - Base 63mm / 30-100 Kg	€ 7.98
0B Ø M12 - Base 70mm / 80-150 Kg	€ 11.59
1B Ø M12 - Base 90mm / 100-350 Kg	€ 13.89
2B Ø M16 - Base 106mm / 300-600 Kg	€ 17.68
3B Ø M16 - Base 127mm / 500-900 Kg	€ 23.18
4B Ø M16 - Base 150mm / 800-1500 Kg	€ 28.08
5B Ø M16 - Base 170mm / 1300-2000 Kg	€ 48.58

série baixo perfil com parafuso fixo

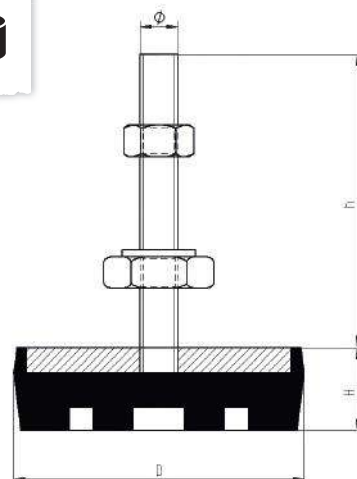

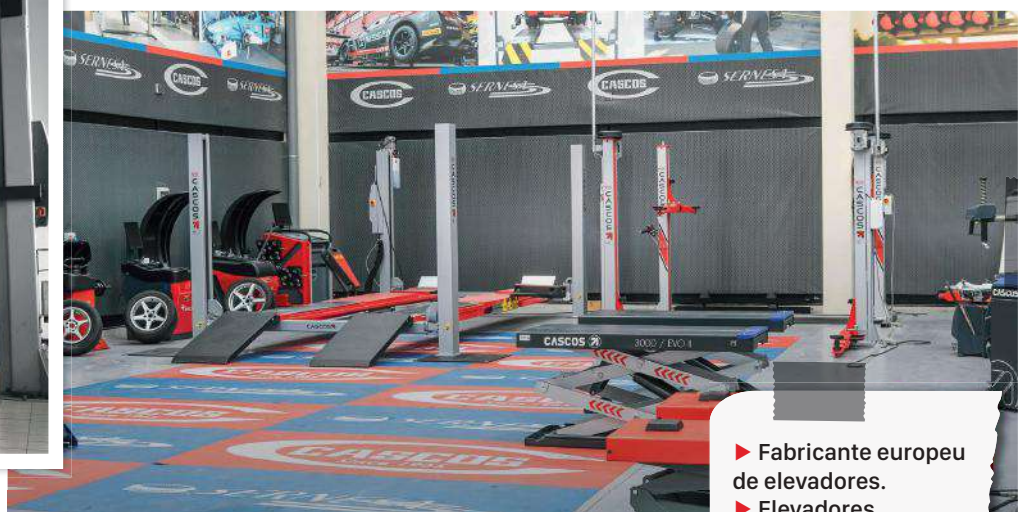







- ▶ Fabricante europeu de elevadores.
- ▶ Elevadores confiáveis e de longa duração, fabricados com materiais de grande qualidade.
- ▶ Símbolo de qualidade para oficinas de reparação de veículos.



ELEVADOR 2 COLUNAS C3.2
Capacidade Elevação 3.2Ton. Trifásico.
Dimensões: 3160x2435mm.

fiável 

-  Min **100 MM**
-  **3200 KG**
-  **580 KG**
-  **400/230V. 3.7KW**
-  **45"**
-  **4 DUPLOS BRAÇOS**



sólido 

indeformável 

MADE IN SPAIN



CA13120E
€ 4900.00

Colunas extremamente resistentes e menos volumosas graças aos perfis SLENDER TECTM, utilizados na sua fabricação. Maior espaço de trabalho entre colunas 2700mm. Braços simétricos (4 iguais) permitem levantar o veículo em ambas as direções de posicionamento do motor. Esta reversibilidade permite que se adapte a qualquer espaço ou tarefa sem se preocupar com a localização da fonte de energia, iluminação, e outras barreiras arquitetónicas.

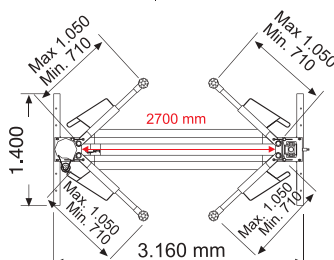
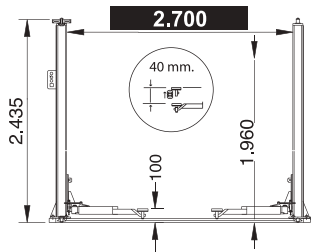

CASCOS

Extratores, ferramentas para automóveis e ferramentas especiais

© PARA MAIS INFORMAÇÕES
TÉCNICAS CONTACTE O NÓSSO
SERVIÇO DE APOIO AO CLIENTE.

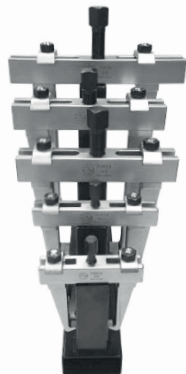

1.

2.

3.

4.

1. EXTRATOR DE 2 PATAS RÍGIDAS

FZ1001 50X60mm	€ 55.87
FZ1002 80X80mm	€ 72.39
FZ1003L 135X115mm	€ 87.20
FZ1010 160X155mm	€ 148.40
FZ1010L 220X145mm	€ 159.07
FZ1015 220X195mm	€ 185.50

2. EXPOSITOR SÉRIE 1000 PATAS RÍGIDAS

FZ1000N
6 pcs. Extratores de 2 patas rígidas.

Obs: Fuso c/ cabeça quadrada, para uma aderência correcta. Abertura e fecho rápido c/ uma só porca.

€ 711.10

3. EXTRATOR UNIVERSAL DE 2 PATAS RÍGIDAS

FZ2410 100X95mm	€ 70.16
FZ2415 100X135mm	€ 74.37
FZ2420 150X165mm	€ 116.64
FZ2425 155X190mm	€ 121.11
FZ2430 205X240mm	€ 188.60
FZ2435 200X350mm	€ 204.53

4. EXPOSITOR SÉRIE 2400 PATAS RÍGIDAS

FZ2400A
5 pcs. Extratores de 2 patas rígidas.

Obs: Fuso de cabeça hexagonal. Pode ser utilizado ocasionalmente para aplicações internas.

€ 570.87



5.



6.



7.



8.

5. EXPOSITOR DE EXTRATORES HX

FZ1000AHX
5 pcs. Extratores de 2 pernas rígidas. Maior rigidez na extração: a força é aplicada diretamente no corpo. Montagem mais rápida.

€ 622.40

6. EXTRATOR COM ALARGADORES

FZ1102S 115X110mm	€ 55.51
FZ1103S 115X140mm	€ 63.10
FZ1110S 175X195mm	€ 126.19
FZ1115S 175X245mm	€ 144.27

7. EXTRATOR GUILHOTINA SÉRIE 1200

FZ1202A 60X60mm	€ 60.26
FZ1203A 115X140mm	€ 79.01
FZ1204B 175X195mm	€ 109.93
FZ1206B 175X245mm	€ 223.80

8. EXTRATOR OSCILANTE SÉRIE 1300

FZ1300T 55x70mm.	€ 42.96
FZ1301T 85x100mm	€ 58.61
FZ1304T 135x150mm	€ 88.06
FZ1307T 180x200mm	€ 117.50
FZ1310T 300x310mm	€ 266.16



9.



10.



11.



12.

9. EXTRATOR AUTOCENTRANTE SÉRIE 1300 ALT

FZ1301ALT 105x110mm. Obs: Combina com 2/3 patas.	€ 117.41
FZ1304ALT 135x185mm. Obs: Combina com 2/3 patas.	€ 151.50
FZ1307ALT 225x240mm. Obs: Combina com 2/3 patas.	€ 218.13

10. EXPOSITOR SÉRIE 1300 2/3 PATAS AUTOCENTRANTES

FZ1300A 3 pcs. Extratores de 2 patas rígidas. Obs: Melhor aderência graças à centragem automática das pernas.	€ 510.19
--	-----------------

11. EXPOSITOR DE EXTRATORES SÉRIE 7300A

FZ7300A 3 pcs. Extratores de 3 pernas autocentrantes. Permite diferentes posições das pernas.	€ 589.36
---	-----------------

12. EXTRATOR DE 2/3 PATAS REVERSÍVEIS

FZ1401LT 85x130mm. Obs: Combina com 2/3 patas.	€ 58.87
FZ1404LT 185x175mm. Obs: Combina com 2/3 patas.	€ 89.34
FZ1407LT 180x240mm. Obs: Combina com 2/3 patas.	€ 130.16



13.

13. EXTRATOR DE PATAS FINAS

FZ1750
145x140mm.

Nota: Assegure-se que as patas estão introduzidas o máximo possível.

€ 137.81



14.

14. JOGO DE EXTRATORES DE PATAS FINAS

FZ9075
FZ1750.
FZ1750C.
FZ1750L.

€ 363.86



1750C 110x140MM 1750 145x140MM 1750L 195x140MM



15.

15. JOGO DE EXTRATORES PEQUENOS SÉRIE 9300

FZ9300K
FZ9300.
FZ9300T.
FZ9301.
FZ9301T.

€ 142.46

Obs: Até 1 Tonelada.



16.

16. JOGO DE EXTRATORES COMBI COM ADAPTADORES ROSCADOS

FZ9082
FZ1102.
(2x)FZ100250.
FZ1202A.

€ 249.71

Obs: Até 2 Toneladas.



17.

17. JOGO DE EXTRATORES COMBI 4 TON

FZ9084
2/4 Toneladas.

Obs: Grande quantidade de composições para extração.

€ 387.27



18.

18. JOGO DE EXTRATORES COMBI 7 TON

FZ9087
2/7 Toneladas.

Obs: Grande quantidade de composições para extração.

€ 670.21



1010H 1407 1110+12048 1407T 1307L 2301-2302 1307LT



19.

19. JOGO DE EXTRATORES 10 TON

FZC1110SC
FZ1110S - 175x195mm.
FZ1204B - 110x110mm.
FZ1010 - 160x155mm.
FZ1110L - 370x195mm.

€ 387.61

Ponte + guilhotina + patas + alargadores + protetor de ponto + porcas de ligação.



20.

20. EXTRATOR HIDRÁULICO COM PATAS OSCILANTES 8 TON

FZ1308TH
225x60mm.

€ 300.05

Obs: Combina com 2/3 patas.



21.

21. EXTRATOR HIDRÁULICO AUTOCENTRANTE 8 TON

FZ7308ALTH
270X280mm.
8 Toneladas.

Obs: Mordentes e ranhura muito finos para receber parafusos.

€ 409.90



22.

22. EXTRATOR HIDRÁULICO AUTOCENTRANTE 12 TON

FZ1312THA
225X260mm.
12 Toneladas

Dica: Apertar o sub-eixo com uma chave de bocas 17 mm. Não utilizar chaves de fendas ou pés-de-cabra.

€ 486.51



23.

23. CONJUNTO EXTRADORES HIDRÚLICOS COMPLETO 8 TON

FZC1005
8 Toneladas.

€ 813.01



1010H 1010LH 150X175 332X175 2 PATAS 1308TH 1204B



24.

24. EXTRATOR AUTOCENTRANTE DE 2 PATAS SÉRIE 7500

FZ7501
100x70mm **€ 87.89**

FZ7502
102x132mm **€ 105.87**

FZ7504
142x186mm **€ 127.74**

FZ7507
177x260mm **€ 187.83**

FZ7510
215x300mm **€ 312.03**



25.

25. EXTRATOR AUTOCENTRANTE DE 3 PATAS

FZ7501T
100x70mm **€ 102.77**

FZ7502T
102x132mm **€ 140.49**

FZ7504T
142x186mm **€ 168.97**

FZ7507T
177x260mm **€ 249.71**

FZ7510T
215x300mm **€ 378.31**



26.

26. EXPOSITOR SÉRIE 7500 2/3 PATAS AUTOCENTRANTES

FZ7500B
6 pcs. Extractores auto-ajustáveis com 2 ou 3 pernas auto-centrantes. **€ 833.67**



27.

27. EXTRATOR DE PATAS OSCILANTES SÉRIE 2740

FZ2741
80x80mm. **€ 35.73**

FZ2743
116x122mm. **€ 44.16**

FZ2745
160x161mm. **€ 65.94**

FZ2748
200x202mm. **€ 78.84**



28.

28. EXTRATOR DE PATAS OSCILANTES

FZ2741T 80x80mm. **€ 45.44**

FZ2743T 116x122mm. **€ 53.71**

FZ2745T 160x161mm. **€ 82.63**

FZ2748T 200x202mm. **€ 100.03**



29.

29. EXTRATOR DE ROLAMENTOS TIPO TESOURA

FZ2641 90x95mm. **€ 67.31**

FZ2642 120x125mm. **€ 84.44**

FZ2643 160x125mm. **€ 101.14**



30.

30. EXTRATOR DE ROLAMENTOS

FZ1700-1 608-6001. **€ 287.86**

FZ1700-2 6002-6302. **€ 470.31**

FZ1700-3 6004-6306. **€ 617.34**

FZ1700-4 6006-6309. **€ 701.49**

FZ1700-5 6010-6312. **€ 996.43**



31.

31. EXTRATOR DE LIMPA PÁRA-BRISAS

FZ5701L abert. 28mm.

Obs: Para aplicações onde o eixo coincide com o esguicho da água do limpa pára-brisas. **€ 45.01**



32.

32. JOGO EXTRATOR DE LIMPA PÁRA-BRISAS

FZ5700 Vários modelos.

Obs: Pode ser montado com: FZ1001 - FZ5701 - FZ5702 - FZ5701L - FZ5702L. **€ 136.43**



33.

33. EXTRATOR MÚLTIPLO SÉRIE 1800

FZ1805 140x173mm **€ 137.30**

Obs: 4 conjuntos de mordentes diferentes.

FZ1810 182x250mm **€ 195.57**

Obs: 4 conjuntos de mordentes diferentes.



34.

34. EXTRATOR MÚLTIPLO EM ESTOJO

FZ1805C FZ1805 c/ estojo. **€ 150.10**

Obs: Inclui protetor de ponta. Fuso c/ inserto rotativo de 90°.

FZ1810C FZ1810 c/ estojo. **€ 224.07**

Obs: Inclui protetor de ponta. Fuso c/ inserto rotativo de 90°.



35.

35. JOGO DE EXTRATORES INTERIORES

FZ25-1 Ø5 - Ø34mm. FZ2521. FZ4390. FZ2525 FZ2500. FZ2510. FZ2511. FZ2512. FZ2513. FZ2514. **€ 463.96**

Obs: Com ponte e barra de impacto.



36.

36. JOGO DE EXTRATORES INTERIORES SÉRIE 43

FZ43-22
Ø5 a Ø45 mm.
FZ4305-FZ4338.
FZ4390-FZ4392.

Obs: Com ponte e barra de impacto

€ 538.07



37.

37. BARRA DE IMPACTO SÉRIE 4393

FZ4393
Massa 2Kg.

Obs: A extração com barra de impacto é a extração mais eficiente e mais rápida. Pode ser montada em posição curta para extrações em espaços confinados.

€ 127.40



38.

38. EXTRATOR INTERIOR E EXTERIOR COM BARRA DE IMPACTO

FZ4702C
FZ4702.
FZ4390.
Exterior: 0-75mm.
Interior: 25-100mm.

Dica: Em Ø interiores superiores a 60mm é melhor trabalhar com a pata de exterior invertida.

€ 195.91



39.

39. CONJUNTO DE EXTRATORES INTERIORES+EXTERIORES

FZ4720
Int. Ø 12-100mm.
Ext. Ø 0-75mm.

Inclui: 3 extratores interiores+barra de impacto.

€ 374.36



40.

40. EXTRATOR DE INTERIORES DE 2/3 PATAS AJUSTÁVEL

FZ7504I
Ø 40-155mm.
2 Patas. 4 Ton.

€ 146.76



41.

41. EXTRATOR DE INTERIORES+ EXTERIORES DE 2/3 PATAS AJUSTÁVEL

FZ7504IC
Ø 40-155mm.
2 Patas. 4 Ton.

€ 167.94



42.

42. EXTRATOR DE INTERIORES+ EXTERIORES DE 2/3 PATAS AJUSTÁVEL

FZC7504B
Int. Ø 25-155mm.
Ext. Ø 30-186mm.
2 Patas. 4 Ton.

Obs: Com barra de impacto

€ 272.53



43.

43. CONJUNTO DE EXTRATORES INTERIORES+EXTERIORES AJUST.

FZ7504KI
Ø 40-155mm.
2 Patas. 4 Ton.

Inclui: Patas exteriores.
Obs: Indicado p/ trabalhar c/ barra de impacto FZ4393. Fuso de cabeça sextavada.

€ 213.73

FZ7504IT
Ø 40-155mm.
3 Patas. 4 Ton.

€ 195.66

FZ7504ICT
Ø 40-155mm.
3 Patas. 4 Ton.

€ 227.41

FZC7504TB
Int. Ø 25-155mm.
Ext. Ø 30-186mm.
3 Patas. 4 Ton.

Obs: Com barra de impacto

€ 332.00



44.

44. CONJUNTO DE EXTRATORES INTERIORES+EXTERIORES AJUST.

FZ7504KIT
Ø 40-155mm.
2/3 Patas. 4 Ton.

€ 480.66



45.

45. JOGO DE EXTRATOR DE INJETORES

FZ6150
Inclui: Barra de impacto e chave Allen.

€ 222.09



46.

46. JOGO DE EXTRATOR UNIVERSAL INJETORES

FZ5156

Inclui: Chave hexagonal 10 c/ furo. Adaptadores macho M17, M20, M25, M27. Adaptadores fêmea M14 e M27 c/reforço. Adaptador extrator de anilhas. Chave hexagonal c/ haste de 25-30 mm. Barra de impacto 2Kg c/ extensor.

€ 324.29



47.

47. JOGO DE EXTRATOR DE INJETORES C/BARRA IMPACTO

FZ5150C
Inclui: Barra de impacto e ponte.

€ 339.33

Obs: Indicado para injetores Bosch, Delphi e Siemens.



48.

48. JOGO DE EXTRATOR DE INJETORES MASTER

FZ5158
Inclui: Barra de impacto FZ4390 + ponte FZ5251 + dois conjuntos de alicates FZ5154 e 8 adaptadores como FZ5150.

€ 529.39



49.

49. JOGO DE EXTRATORES DE ROLAMENTOS DE ESFERAS

FZ4100
20 a 95mm.

€ 101.34

FZ4105
35 a 117mm.

€ 237.06

FZ4125
Indicado p/ rolamentos: 6018 a 6030 - 6212 a 6224 - 6309 a 6319 - 6407 a 6414.

€ 551.97



50.

50. JOGO DE EXTRATORES DE ROLAMENTOS DE ESFERAS

FZ1600-1
FZ6000-FZ6303.

€ 264.43

FZ1600-A
6000-6406.
Jogo completo de 3 extratores.

€ 859.76



51.

51. EXTRATOR DE PARAFUSOS

FZ5010
5 ext. estriados - M5-20.

€ 41.83

FZ5010E
5 ext. estriados - M5-20.

€ 35.16

FZ5010C
FZ5010+guias duplas e brocas int. e ext.

€ 84.19

FZ5010CD
FZ5010+guias duplas e brocas int. e ext.

€ 87.89

FZ5010KI
FZ5010+brocas à es-q+guias duplas int. e ext.

€ 108.71



52.

52. EXTRATOR DE PARAFUSOS ROSCA ESQUERDA

FZT51300
5 peças - 4 a 20mm.

€ 12.06



53.

53. EXTRATOR DE PARAFUSOS QUADRADOS HELICODAIS

FZ5010N
M6-M16.
Inclui: FZ5011 +
FZ5012N + FZ5013N
+ FZ5014N.

€ 63.44



54.

54. JOGO DE 5 EXTRADORES DE PARAFUSOS PARTIDOS

FZ5010R
5 a 22 mm.
5 extratores de
rosca esq. Cr.Va.

Inclui: FZ5011R-
FZ5012R-FZ5013R-
FZ5014R-FZ5015R.

€ 22.81



55.

55. CONJUNTO DE 5 EXTRADORES DE PARAFUSOS PARTIDOS

FZ5010RE
M5-M20.
Obs: Rosca cônica
esq.

€ 19.97



56.

56. CONJUNTO DE 5 EXTRADORES DE PARAFUSOS PARTIDOS

FZ5135
3-9.5mm.
M5-M18.
Obs: Quadrado

€ 30.13



57.

57. EXPOSITOR DE EXTRADORES DE PARAFUSOS PARTIDOS

FZ50100
2 modelos diferentes.
Inclui: 3xFZ5010E +
6xFZ5010RE.

€ 193.59



58.

58. EXPOSITOR DE EXTRADORES DE PARAFUSOS PARTIDOS

FZ5010DEMO
3 pcs. Extratores de 3
pernas autocentrantes.
Permite diferentes
posições das pernas.

€ 132.96



59.

59. EXTRATOR DE RÓTULAS

FZ2301
Ø4.5-9.5mm.

€ 35.47

FZ2302
Ø8-19mm.

€ 56.21



60.

60. EXTRATOR DE RÓTULAS UNIVERSAL

FZ5681 50/18-22. **€ 56.13**

FZ5683 95/28-32. **€ 119.64**



61.

61. EXTRATOR DE RÓTULAS AÇÃO DIRETA

FZ5651 18x40x35mm. **€ 34.94**

FZ5652 25x50x45mm. **€ 40.89**

FZ5653 29x60x55mm **€ 58.87**

FZ5654 40x80x80mm. **€ 76.19**

FZ5655 58x80x80mm. **€ 106.47**

FZ5656 46x90x100mm. **€ 116.47**



62.

62. EXTRATOR DE RÓTULAS AXIAIS

FZ5660 ØInt. 41mm Ø comprimento total 85mm. **€ 62.23**



63.

63. EXTRATOR DE RÓTULAS DE ALAVANCA PARA CAMIÕES

FZ5695 Ø35 mm.

Obs: Corpo e alavanca reforçados para uma elevada resistência ao esforço.

€ 153.21



64.

64. EXTRATOR DE RÓTULAS DE ALAVANCA DE 2/4 POSIÇÕES

FZ5691 Ø20-24 mm. **€ 87.11**

Obs: Os seus dois orifícios permitem trabalhar em duas posições de altura diferentes.



65.

65. EXTRATOR DE PARAFUSOS E RÓTULAS

FZ9001 Inclui: FZ2301+ FZ2302 +FZ5010CD. **€ 121.37**



66.

66. EXTRATOR DE PRATOS MAGNÉTICOS

FZ5216 M16x100 **€ 24.10**

FZ5226-1 M26x100 **€ 25.91**

FZ5219 M19x100 **€ 24.01**

FZ5227 M27x125 **€ 25.91**

FZ5223-15 M23x150 **€ 25.04**

FZ5227-1 M27x100 **€ 25.91**

FZ5224-1 M24x100 **€ 25.04**

FZ5227-1I2 M27x100 Esq. **€ 26.34**



67.

67. JOGO DE 8 EXTRATORES DE PRATOS MAGNETICOS

FZ5200A
M16-M27.

€ 170.96



68.

68. JOGO DE EXTRATORES COM ROLOS

FZT51310
M6/M8/M10/M12.

€ 98.99



69.

69. EXTRATOR DE SILENT-BLOCKS

FZ5198
Ø34-72mm.

Incluí:
4 eixos com porcas e rolamentos M10, M12, M14 e M16. 8 cápsulas múltiplas. 20 tubos para montar e desmontar.

€ 589.64



70.

70. JOGO DE PASSADORES ROSCADOS

FZ1950
M4, M5, M6, M8, M10

€ 123.09

FZ1960
M6 a M20 + 3/8" - 5/8"

€ 200.56



71.

71. DESMONTADOR E MONTADOR DE CORRENTE

FZ5110
1"-3/4"
Obs: Desmonte correntes de até 1" rebite correntes até 3/4"

€ 192.81



72.

72. RESTAURADORES DE ROSCAS EXTERIORES

FZNES1A
Ø4-48mm.
Incluí: Lâmina RK1-60.

€ 122.60

FZNES2
Ø17-38mm.
Incluí: Lâmina RK2-60.

€ 177.79

FZNEST
Ø M4 a M13.

€ 51.97



73.

73. JOGO DE RESTAURADORES DE ROSCAS INTERIORES E EXTERIORES

FZNES1012
Int.Ø8-16mm.
Ext.Ø4-18mm.

Incluí: lâminas adicionais RK1-60, RK21-60, RK22-60.

€ 387.90



74.

74. JOGO DE RESTAURADORES DE ROSCAS EXTERIORES

FZNES12
Ø4-38mm.

Incluí: lâminas adicionais RK1-60, RK2-60.

€ 313.97



75.

75. JOGO DE RESTAURADORES DE ROSCAS INTERIORES E EXTERIORES

FZNES1025
Int.Ø8-32mm.
Ext.Ø4-38mm.

€ 934.73

Inclui: lâminas adicionais
RK1-60, RK2-60, RK21-60,
RK22-60, RK23-60, RK24-
60



76.

76. PUNÇÃO INDIVIDUAL CORPO ÓCTOGONAL

FZ872003B 3x150mm.	€ 4.13
FZ872004B 4x150mm	€ 4.13
FZ872005B 5x150mm.	€ 4.13
FZ872006B 6x150mm.	€ 4.13
FZ872008B 8x150mm.	€ 4.77
FZ872010B 10x150mm.	€ 4.77



77.

77. PUNÇÃO INDIVIDUAL COM PEGA

FZ871003B 3x150mm.	€ 6.60
FZ871004B 4x150mm	€ 6.60
FZ871005B 5x150mm.	€ 6.60
FZ871006B 6x150mm.	€ 6.60
FZ871008B 8x150mm.	€ 7.60



78.

78. CONJUNTO DE PUNÇÕES SEM PEGA

FZ87200C Ø3-10mm. Caixa plástica.	€ 29.30
Obs: Aço Cromo-Vanádio.	
FZ87200E Ø3-10mm. Suporte de plástico.	€ 31.04
Obs: Aço Cromo-Vanádio.	



79.

NEW

79. JOGO DE PUNÇÕES DE 3 A 20MM

FZ86320M
Ø3-20mm.

€ 95.84

Obs: Cabo escalonado p/ punções.



80.

NEW

80. JOGO DE PUNÇÕES DE 3 A 30MM

FZ86330M
Ø3-30mm.

€ 131.94

Obs: Pega ergonómica, bi-material com espaço de fixação antiderrapante. Cabeça de impacto reforçada.



81.

NEW

81. JOGO DE PUNÇÕES DE 3 A 30MM + COMPASSO

FZ86330MC
Ø3-30mm.

€ 203.61

Obs: Pega ergonómica, bi-material com espaço de fixação antiderrapante. Cabeça de impacto reforçada. Compasso regulável até 330mm com lâmina.



82.

NEW

82. JOGO DE PUNÇÕES DE 2 A 50MM

FZ86250M
Ø2-50mm.

€ 591.96

Obs: Pega ergonómica, bi-material com espaço de fixação antiderrapante. Ponta de centragem retrátil. Cabeça de impacto reforçada.



83.

NEW

84.



83. EXPOSITOR DE PUNÇÕES DE 3 A 8MM

FZ87100E
Ø3-8mm.

Obs: Pega ergonómica, bi-material. Expositor metálico.

€ 39.73

84. PERFURADORES DE CHAPA VALLCIA

FZ56/16 Ø 16mm	€ 40.63
FZ56/18 Ø 18mm	€ 42.87
FZ56/20 Ø 20mm	€ 46.31
FZ56/22 Ø 22mm	€ 46.31
FZ56/25 Ø 25mm	€ 50.53
FZ56/28 Ø 28mm	€ 60.26

FZ56/30 Ø 30mm	€ 60.51
FZ56/32 Ø 32mm	€ 60.51
FZ56/35 Ø 35mm	€ 66.97
FZ56/37 Ø 37mm	€ 66.97
FZ56/40 Ø 40mm	€ 74.97
FZ56/45 Ø 45mm	€ 80.83

FZ56/47 Ø 47mm	€ 85.30
FZ56/50 Ø 50mm	€ 84.96
FZ56/55 Ø 55mm	€ 129.99
FZ56/60 Ø 60mm	€ 152.87
FZ56/63 Ø 63mm	€ 168.46



81.

81. PERFURADORES DE CHAPA REDONDOS MECÂNICOS

FZ54/16 Ø 16mm	€ 27.97
FZ54/18 Ø 18mm	€ 30.47
FZ54/20 Ø 20mm	€ 34.86
FZ54/22 Ø 22mm	€ 34.86
FZ54/25 Ø 25mm	€ 40.54
FZ54/28 Ø 28mm	€ 47.26

FZ54/30 Ø 30mm	€ 47.26
FZ54/32 Ø 32mm	€ 47.26
FZ54/35 Ø 35mm	€ 52.77
FZ54/37 Ø 37mm	€ 52.77
FZ54/40 Ø 40mm	€ 59.14

82.

82. PERFURADORES DE CHAPA VALLCIA

FZ54VAL16 Ø 16mm	€ 18.50
FZ54VAL18 Ø 18mm	€ 20.06
FZ54VAL20 Ø 20mm	€ 21.00
FZ54VAL22 Ø 22mm	€ 22.81
FZ54VAL25 Ø 25mm	€ 25.21
FZ54VAL28 Ø 28mm	€ 27.80



FZ54VAL30 Ø 30mm	€ 27.63
FZ54VAL32 Ø 32mm	€ 28.40
FZ54VAL35 Ø 35mm	€ 31.67
FZ54VAL37 Ø 37mm	€ 31.84
FZ54VAL40 Ø 40mm	€ 43.04



83.

83. JOGO DE PERFURADORES DE CHAPA MECÂNICOS

FZ54J41 Ø18-20-22-37mm.	€ 159.96	FZ54J45 Ø14-18-20-32mm.	€ 148.71
FZ54J42 Ø16-20-25-32mm.	€ 163.33	FZ54J46 Ø15-20-22-28mm.	€ 151.46
FZ54J43 Ø18-22-25-32mm.	€ 150.99	FZ54J48 Ø16-19-25-32mm.	€ 154.64
FZ54J44 Ø16-20-25-32mm.	€ 157.39	FZ54J49 Ø12.7-19-25-32mm.	€ 154.64



MÁXIMA PRECISÃO



84.

84. EXPOSITOR PERFURADORES DE CHAPA MECÂNICOS

FZPX54
14 pcs.
Ø20-22-25-28-30-32-35 mm. (2un cada). € 700.69



85.

85. CHAVES PARA PORCAS CASTELADAS TIPO KM

FZ96104 KM4 - Ø32	€ 75.74
FZ96105 KM5 - Ø38	€ 79.19
FZ96106 KM6 - Ø45	€ 85.64
FZ96107 KM7 - Ø52	€ 93.83
FZ96108 KM8 - Ø58	€ 103.56
FZ96109 KM9 - Ø65	€ 113.20



86.

86. JOGO DE 7 CHAVES PARA PORCAS KM CURTAS

FZ96110 KM10 - Ø70	€ 123.53
FZ96111 KM11 - Ø75	€ 144.61
FZ96112 KM12 - Ø80	€ 162.26
FZ96113 KM13 - Ø85	€ 182.91
FZ96114 KM14 - Ø92	€ 213.90

FZ96800
KM4 - KM10 sem prolongador. € 275.89

Obs: Têm praticamente o mesmo diâmetro da porca.



87.

87. JOGO DE 4 CHAVES PARA PORCAS KM COMPLETAS

FZ96801
KM4 - KM7 com prolongador.

Obs: Permite a extração em espaços profundos e confinados graças à extensão obtida com o prolongador

€ 334.41



88.

88. JOGO 7 CHAVES PARA PORCAS KM COMPLETAS

FZ96802
KM4 - KM10 com alargador.

Obs: Permite a extração em espaços profundos e confinados graças à extensão obtida com o prolongador.

€ 674.26



89.

89. EXPOSITOR SÉRIE 7500 CHAVES DE PORCAS KM

FZ96700A
7 pcs.

Obs: Permite a extração em aplicações profundas e com falta de espaço graças a uma extensão.

€ 469.99

FZ96700M
7 pcs+ mala.

Obs: Permite a extração em aplicações profundas e com falta de espaço graças a uma extensão.

€ 745.87



90.

90. CHAVE RÁPIDA COM ROQUETE

FZ821030
13-30mm.

€ 58.53



91.

91. CHAVE ACIONAMENTO REVERSÍVEL RÁPIDO

FZ82012
170mm.

€ 24.63

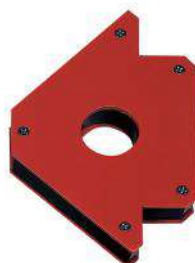

92.

92. ESQUADRO MAGNÉTICO

FZP29003
120x70mm. 40°/90°.
Obs: Resistente a altas temperaturas.

€ 16.33

FZP29004
159,5x92mm. 40°/90°.
Obs: Resistente a altas temperaturas.

€ 26.04

FZP29005
201x125mm. 40°/90°.
Obs: Resistente a altas temperaturas.

€ 42.37



93.

93. LIMAS PARA ROSCAS

FZ59301
Withworth 11-24

€ 29.90

FZ59302
Withworth 9-32

€ 29.90

FZ59304
Métricas 0,75-3

€ 29.90

FZ5930
Jogo. Inclui: FZ59301
FZ59302,59304.

€ 70.51



94.

94. FERRAMENTAS DE INSPEÇÃO

FZH6612
Espelho 45X60mm.

€ 19.76

FZH6640
Iman 552mm.

€ 13.69

FZH6665
Caneta Iman 160-475mm.

€ 18.99



95.

95. PASTA GRIPANTE SCREW GRAB

FZGG005
Ajuda a soltar e apertar parafusos danificados.

€ 10.16

Obs: Aumenta o aperto em 40%.



96.

96. EXTRATOR DE CUBOS DE RODAS

FZ5503
3 patas. Abertura 250mm. Alt.140mm.

€ 200.26

FZ5504
4 patas. Abertura 250mm. Alt.140mm.

€ 225.59

FZ5505
5 patas. Abertura 250mm. Alt.140mm.

€ 255.53



97.

97. CHAVE QUADRADA PARA TAMPÕES DE ÓLEO

FZ5182
8mm.

€ 7.74

Obs: Chave dupla.

FZ5184
10mm.

€ 8.61

Obs: Chave dupla.

FZ5186
8-10mm.

€ 13.94

Obs: Chave dupla.



98.

98. ALAVANCA PARA DESMONTAR PNEUS

FZRUD120
8-10mm.

€ 45.80

Obs: Alavanca vulcanizada.



99.

99. ANEL DE CALIBRAGEM PARA PNEUS

FZRUD1013
M. 10 - 13".

€ 127.06

FZRUD1418
L. 14 - 18".

€ 127.06

FZRUD1921
XL. 19 - 21".

€ 136.63

FZRUD2224
XXL. 22.5 - 24".

€ 191.31



100.

100. ALICATES DE FREIOS INTERIORES E EXTERIORES

FZ5830N
ext. 3/26 - int. 7/26.

Inclui: 3 jogos de pontas retas e 3 jogos de pontas curvas. Obs: Pontas intercambiáveis interiores e exteriores.

€ 57.50

FZ5840N
ext. 7/51 - int. 10/51.

Inclui: 3 jogos de pontas retas e 3 jogos de pontas curvas. Obs: Pontas intercambiáveis interiores e exteriores.

€ 65.21



101.

101. JOGO DE ALICATES DE FREIOS INTERIORES E EXTERIORES

FZ5800N
Jogo com 3 modelos.

€ 286.81

Obs: (12X3) = 36 alicates diferentes.

FZ5800S
Jogo com 2 modelos.

€ 152.19

Obs: (12X2) = 24 alicates diferentes.



102.

102. ALICATE EXTRATOR DE FILTROS ÓLEO

FZT51870
Ø45-89mm.

€ 31.34

Obs: 2 posições de trabalho.



103.

103. CHAVE DE FILTROS DE ÓLEO DE GARRA MAGNÉTICA

FZ5000M
Ø55-72mm. **€ 68.94**

FZ5001M
Ø68-110mm. **€ 96.59**

FZ5001GM
Ø110-142mm. **€ 189.37**



104.

104. CHAVE DE FILTROS DE ÓLEO DE GARRA

FZ5000
Ø55-72mm. **€ 66.37**

FZ5001
Ø68-110mm.
Indicado: para chave fixa ou chave inglesa. **€ 93.06**

FZ5001G
Ø110-142mm.
Indicado: para chave fixa ou chave inglesa. **€ 177.93**



105.

105. CHAVE DE FILTROS DE ÓLEO DE GARRA DE CHAPA

FZT51530
Ø62-93mm. **€ 39.61**

Obs: Tipo deslizante.



106.

106. CHAVE DE FILTROS DE ÓLEO DE CINTA

FZ5002
Ø 65-110mm. **€ 13.60**

FZ500238
Cinta FZ5002. **€ 2.24**

FZ5003
Ø 20mm. **€ 15.41**

FZ500338
Cinta FZ5003. **€ 3.27**



107.

107. CHAVE DE FILTROS DE ÓLEO DE CORREIA

FZ15500
Ø279mm. **€ 45.91**

Obs: pega com efeito de alavanca.

FZT51510
Ø300mm. **€ 32.89**

Obs: pega com efeito de alavanca.



108.

108. CORTA PORCAS MECÂNICO

FZ6311
4-17mm. **€ 48.89**

FZ6312
8-24mm. **€ 57.59**

FZ6313
19-36mm. **€ 83.93**



109.

109. EXPOSITOR DE CORTA PORCAS MECÂNICOS

FZ6300
3 modelos diferentes. **€ 380.81**
Inclui: 2xFZ6311 (até M10).

FZ6300I
FZ6311 + FZ6312 + FZ6313 + FZ6311I + FZ6312I + FZ6313I **€ 436.93**

Obs: Pontos de referência. Suporte que facilita o corte da porca. Afiadas a 60° para um corte mais suave.



110.

110. DESPOLIDOR DE CILINDROS DE VEÍCULOS

FZ28100
50-180mm. **€ 66.56**

Obs: Ferramenta para cilindros maiores, como carros, carrinhas, barcos e instalações industriais.



111.

111. PEDRAS DE SUBSTITUIÇÃO PARA DESPOLIDOR DE CILINDROS

FZ28101 Fina 400.	€ 24.00
FZ28102 Média 220.	€ 29.90
FZ28103 Grossa 100.	€ 29.61



112.

112. PRENSA HIDRÁULICA 8 TON SÉRIE 2660

FZ2660 9 Toneladas.	€ 129.03
------------------------	-----------------

Obs: O retorno do êmbolo pode ser realizado manualmente.



113.

113. PRENSA HIDRÁULICA

FZ2650 3 patas. Abertura 250mm. Alt.140mm.	€ 150.13
FZ2655 4 patas. Abertura 250mm. Alt.140mm.	€ 229.84



114.

114. PRENSA DE ENGENHO SIMPLES SÉRIE 82

FZ82/85 85x95mm.	€ 134.29
FZ82/85 100x116mm.	€ 198.41
FZ82/125 125x160mm.	€ 232.33
FZ82/150 150x190mm.	€ 262.54



115.

115. PRENSA DE ENGENHO MASTER
Pega incluída. Ferro fundido nodular.

FZ33/85M 65x76mm.	€ 132.59
FZ33/85M 65x76mm.	€ 173.51
FZ33/100M 105x116mm.	€ 256.94
FZ33/125M 125x157mm.	€ 342.59
FZ33/150M 150x190mm.	€ 385.63



116.

116. JOGO PRENSA STANDARD

FZ34/60 Boca 60. 52-60mm	€ 306.79
FZ34/79 Boca 79. 66-78mm	€ 396.83



117.

NEW

Obs: Permite fixar e soltar a peça em segundos. Com mordentes escalonados e dois conjuntos de mordentes macios.

117. TORNO FIXAÇÃO RÁPIDA SÉRIE 38

FZ38/103 420x103mm.	€ 644.49
FZ38/125 555x125mm.	€ 497.50
FZ38/80 385x80mm.	€ 353.40

118.

118. TORNO DE BANCADA

FZ88/100N 100x105mm.	€ 187.17
FZ88/125N 125x130mm.	€ 229.21
FZ88/150N 150x165mm.	€ 428.19





119.

119. GRAMPO PARA PROFISSIONAIS

FZP60040
400x120mm.
€ 47.01

Obs: Sistema de êmbolo, freio antideslizante.

FZP60060
600x120mm.
€ 54.74

Obs: Sistema de êmbolo, freio antideslizante.



120.

120. GRAMPO MÉDIO DE GRANDE APERTO

FZP40200
200x120mm.
Força máx. 9000N.
€ 32.77

FZP40300
300x120mm.
Força máx. 9000N.
€ 36.31

FZP40400
400x120mm.
Força máx. 9000N.
€ 39.51

FZP40600
600x120mm.
Força máx. 9000N.
€ 45.91



121.

121. GRAMPO DE AÇÃO RÁPIDA MINI-750N | EXTRA-1500N

FZP52415 (MINI)
150x55mm.
€ 22.40

FZP52415 (EXTRA)
150x80mm
€ 30.13

FZP52630 (EXTRA)
300x90mm.
€ 33.66

FZP52645 (EXTRA)
450x100mm.
€ 35.76

FZP52660 (EXTRA)
600x100mm.
€ 37.74



122.

122. GRAMPO RÁPIDO VERTICAL

FZP56003
Força Máx. 250kg.
€ 43.26

FZP56004
Força Máx. 340kg.
€ 56.06



123.

123. GRAMPO RÁPIDO HORIZONTAL BRAÇO REFORÇADO

FZP56051
Força Máx. 38kg.
€ 32.56

FZP56052
Força Máx. 90kg.
€ 36.41

FZP56053
Força Máx. 220kg.
€ 44.47



124.

124. PINÇA DE MOLLA AJUSTÁVEL

FZP30910
30x35mm (115mm).
€ 5.30

Obs: Mola endurecida extra forte. Corpo em nylon e fibra de vidro. Pressão ajustável com parafuso.



125.

125. ESCORAS ATÉ 750KG

FZP30010
600-1000mm.
Obs: Sapata antideslizante adaptável a diferentes ângulos. Resistente à oxidação.
€ 48.29

FZP30011
950-1700mm.
Obs: Sapata antideslizante adaptável a diferentes ângulos. Resistente à oxidação.
€ 54.60

FZP30012
1550-2900mm.
Obs: Sapata antideslizante adaptável a diferentes ângulos. Resistente à oxidação.
€ 59.23

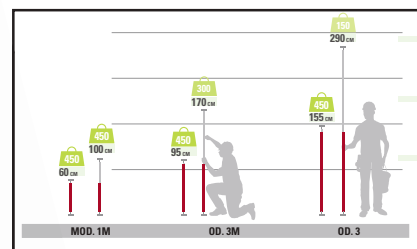

Equipamentos de lubrificação



☎ PARA MAIS INFORMAÇÕES TÉCNICAS CONTACTE O NOSSO SERVIÇO DE APOIO AO CLIENTE.

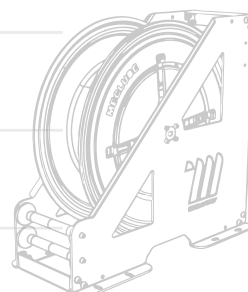
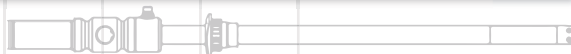

- ▶ Grande variedade de soluções com alta qualidade.
- ▶ Fabricado e produzido em Itália.
- ▶ Utilização simples e segura.
- ▶ Fácil manutenção.



MADE IN ITALY

MC027-3500-250 SERINGA DE ÓLEO 250CC

Corpo em Latão. Ø 40 mm. Comprimento 300 mm. Mangueira rígida em latão com curvatura de 30°.



€ 28.²⁸

MC027-3500-500 SERINGA DE ÓLEO 500 CC

Corpo em Latão. Ø 50 mm. Comprimento 340 mm. Mangueira rígida em latão com curvatura de 30°.



€ 33.⁶²

MC015-3102-000
PISTOLA DE MASSA DE ALAVANCA
Manual. 500cm³. Mangueira flexível 300mm. Válvula de enchimento Ø 9mm. Indicado para cartucho Ø 52mm - 400 gr.



€ 23.⁹⁴

MC015-3105-000
PISTOLA DE MASSA DE ALAVANCA
Manual. 1000cm³. Mangueira flexível 300mm. Válvula de enchimento Ø 9mm. Indicado para cartucho Ø 56mm - 600 gr.



€ 30.⁹⁵

MC014-1081-000
PISTOLA MANGUEIRA FLEXÍVEL
Conexão F 1/4". Mangueira flexível 400mm. 1 kg.



€ 53.³⁹

MC015-3180-000
PISTOLA DE LUBRIFICAR A BATERIA
20V Li-Ion - 2000 mAh. Carregador 12-240V/50-60Hz. Mangueira flexível 1000mm. Indicado para cartucho Ø 52mm - 400 gr.



€ 418.⁰⁴

MC024-1231-A00
BICO DISTRIBUIDOR DE ÓLEO 105°
 Punho com junta giratória F ½".
 Extremidade flexível 105°. Válvula de queda manual Ø 12 mm.



€ 71.⁷⁴

MC024-1233-C00
PISTOLA DE ÓLEO DIGITAL
 Punho com junta giratória F ½".
 Extremidade flexível 105°. Válvula de queda automática Ø 14 mm. Medidor de caudal digital de óleo.



€ 254.⁴⁴

MC027-3705-000
BOMBA MANUAL ROTATIVA
 Capacidade de entrega 0,27 L/rotação.
 Haste para barricas de 30-220 L.
 Adequado para transferência de gasóleo, lubrificantes e gasolina.



€ 61.⁷⁸

MC016-1142-000
BOMBA DE MASSA MANUAL COM RODAS 16KG
 Tanque com rodas 16 kg.
 Mangueira F ¼"x2 m.
 Tubo rígido de 200 mm e acoplamento de 4 garras.
 Placa seguidora Ø 220 mm com mola.



€ 180.¹⁹

MC027-1322-000
DISPENSADOR DE ÓLEO MANUAL 16 L
 Bomba manual. Mangueira 2 m.
 Válvula de nível, extremidade rígida 30°. Caudal: 80cc.
 Capacidade 16 L.
 11.9 kg



€ 178.⁵²

MC027-1305-000
DISPENSADOR DE ÓLEO PNEUMÁTICO 24 L
 Extremidade flexível, válvula de descarga manual Ø 12 mm.
 Mangueira 3 m.
 Capacidade 24 L. 11.7 kg



€ 247.⁷⁶

MC013-1106-000
KIT DE DISTRIBUIÇÃO DE MASSA P/ BIDONS 18-30KG
 Conjunto móvel pneumático sob carro metálico. Bomba 60:1.
 Tampa Ø320mm.
 Membrana Ø310mm.
 Mangueira ¼"x4 m.
 Pistola de lubrificação com junta giratória.
 Capacidade 18-30 kg.



€ 518.¹⁴

MC040-1420-000
ASPIRADOR DE ÓLEO PNEUMÁTICO 24 L
 Esvaziamento manual do tanque com ar. Equipado com 10 sondas standard. Mangueira 2 m.
 Pressão de ar despressurização 7,5 - 8 bar. Tempo de aspiração de óleo - 1,5 - 2 L/min. (c/sonda Ø 6, temperatura 60-80 °C)



€ 312.⁸³

MC040-1432-000
ASPIRADOR DE ÓLEO PNEUMÁTICO 90L C/APARADOR E FUNIL
 Esvaziamento manual do tanque com ar. Equipado com 10 sondas standard. Bacia de suporte em ABS. Bacia de recuperação com capacidade 20L. Funil ABS ergonómico e giratório 360°. Com grelha de proteção.



€ 667.³⁸

MC040-1435-000
ASPIRADOR DE ÓLEO PNEUMÁTICO 90 L COM PRÉ-CÂMARA
 Esvaziamento pneumático por ar (pressão máxima 0,5 bar). Equipado com 10 sondas standard. Capacidade da pré-câmara 10 L. Capacidade do depósito 90 L com indicador de nível.



€ 695.⁷⁴

MC040-1445-000
ASPIRADOR DE ÓLEO PNEUMÁTICO 90 L COM PRÉ-CÂMARA E APARADOR
 Esvaziamento pneumático por ar (pressão máxima 0,5 bar). Equipado com 10 sondas standard. Capacidade da pré-câmara 10 L. Capacidade do depósito 90 L com indicador de nível. Capacidade da bacia de recuperação 20 L.



€ 862.⁵⁸

MC050-1510-000
NEBULIZADOR AÇO INOXIDÁVEL 24L
 Capacidade do depósito 24 L com indicador de nível.
 Pistola 600mm com tubo de aço inoxidável.
 Mangueira de mola 10 m.



€ 555.⁶¹

MC055-1560-000
TINA DE LAVAGEM PNEUMÁTICA 65 L
 Capacidade do coletor 50 L com tampa removível. Capacidade do tanque 65 L.
 Escova com cerdas de nylon e mangueira de pvc de 1,5 m.



€ 715.⁷⁶

MC080-1791-000
SANGRADOR DE TRAVÕES 10L
 Capacidade do tanque de óleo 10 L. Com mangueira e tampas de conexão de borracha de 90° 2 bacias de recuperação de óleo 1 L. Mangueira de mola 4 m.



€ 510.⁵⁵

MC090-5260-060
KIT DE TRANSFERÊNCIA 60 LPM 230V BOCAL MANUAL
 Bomba 230V - 60 l/min. Mangueira de conexão Ø 20 mm M-M 1" 4 m. Kit mangueira de sucção Ø 25 mm, comprimento 2 m. Bocal manual MC100 caudal 100 l/min.



€ 336.³⁰

MC090-5026-060
KIT DE BATERIA 60 LPM 12V
 Bomba 24V - cabo de alimentação 4 m com pinça e fusível - 60 l/min. Mangueira de conexão Ø 20 mm M-M 1" 4 m. Kit mangueira de sucção Ø 25 mm, comprimento 2 m. Bocal manual MC80 caudal 80 l/min.



€ 463.⁹²

Lubrificação e limpeza



▶ Produtos de alta qualidade nos setores automóvel, construção e industrial.
▶ Fornecedor de referência para todos os tipos de produtos químicos.



1.

1. MASSA KL

Massa de lítio de lubrificação geral. Elevada protecção à corrosão. Antioxidante, anti-corrosivo e anti-ferrugem. Temperatura de Serviço: -20°C até +130°C.

KF15403 400 gr.	€ 4.22	KF15405 5 kg.	€ 32.45
KF15404 1 kg.	€ 7.86	KF15407 20 kg.	€ 118.37

2.

2. MASSA KL COMPLEX 200

KF56235
5 kg. Massa lubrificante de longa duração. Antioxidante, anti-corrosivo e anti-ferrugem. Boa estabilidade térmica. Até 180°C.

€ 55.10

KF56237
20 kg. Massa lubrificante de longa duração. Antioxidante, anti-corrosivo e anti-ferrugem. Boa estabilidade térmica. Até 180°C.

€ 204.08



3.

3. MASSA KCS

KF15455
5 kg. Massa Consistente Cálcica para lubrificação perdida (NLGI 2). Antioxidante, anti-corrosivo e anti-ferrugem. Temperatura de Serviço: -10°C até +55°C.

€ 23.80



4.

4. MASSA KHD - KMS

KF46723
400 gr. Massa com MoS2 e grafite para trabalhos severos em ambientes agressivos. Boa aderência e proteção à corrosão. Temperatura de Serviço: -20°C até +130°C.

€ 4.69



5.

5. MASSA EM SPRAY

KF33962
200 ml. Lubrificante multifuncional. Reduz a fricção, o desgaste. Resistente à água e a ambientes húmidos. Lubrifica eficazmente após longos períodos de paragem.

€ 7.65

KF33963
500 ml. € 10.61



6.

6. MASSA DE LÍTIO EM SPRAY

KF33943
400 ml. Massa lubrificante em spray para rolamentos. Para velocidades médias-altas. Reduz a fricção e o desgaste. Lubrifica eficazmente mesmo após longos períodos de paragem.

€ 8.16



7.

8.

9.

10.

7. MASSA DE ALTA TEMPERATURA

KF33973
400 ml.
Massa lubrificante para temperaturas muito elevadas. Lubrificante anti-corrosivo e anti-gripagem. Elevado poder de lubrificação.

€ 17.35

8. MASSA ABRASIVA P/ VÁLVULAS

KF12063
100 gr. Fino. Grão 180.
Evita a oxidação das válvulas e sedes tratadas.

€ 5.27

KF12073
100 gr. Grosso. Grão 100.
Evita a oxidação das válvulas e sedes tratadas.

€ 5.27

9. SELANTE JUNTA DE SILICONE

KF54291
● 75 ml. Ideal para formação de juntas mecânicas resistentes a óleos e produtos químicos.

€ 6.10

KF54292
● 200 ml. Ideal para formação de juntas mecânicas resistentes a óleos e produtos químicos.

€ 23.08

KF54293
● 300 ml. Ideal para formação de juntas mecânicas resistentes a óleos e produtos químicos.

€ 14.08

10. ÓLEO COMPRESSOR / HIDRÁULICO

KF47375 (Compressor)
5 L. Parafuso/ Pistão.

€ 28.57

KF47395 (Compressor)
5 L. Parafuso/ Pistão.

€ 28.57

KF47575 (Hidráulico)
FH-32-EP. 5 L.

€ 17.35

KF47585 (Hidráulico)
FH-32-EP. 5 L.

€ 17.35

KF47595 (Hidráulico)
FH-68-EP. 5 L.

€ 17.35



11.

12.

13.

14.



11. ÓLEO CORRENTE MOTOSERRA / 2T / 4T

KF55944
Motoserra. 1L.

€ 4.08

KF55924
2T. Sintético. 1 L.

€ 6.63

KF55744
4T. Sintético. 1 L.

€ 6.73

12. ANTICONGELANTE PROFESSIONAL. 20% / 30% / 50%.

KF82255
● 20%. 5 L.

€ 5.05/LT

KF13025
● 30%. 5 L.

€ 7.08/LT

KF13035
● 30%. 5 L.

€ 7.12/LT

KF13175
● 50%. 5 L.

€ 10.02/LT

13. LAVA-MÃOS FAST ORANGE

KF35405
3.78 L.
Natural. Biodegradável.
Aroma cítrico puro e fresco.
Remove suavemente a sujidade mais difícil.

€ 17.35

14. ÓLEO SOLÚVEL LIV Emulsão Verde / Emulsão Branca.

762085
● 5L.

€ 27.22

762092
○ 5L.

€ 43.34

Lavadoras de alta pressão



© PARA MAIS INFORMAÇÕES TÉCNICAS CONTACTE O NOSSO SERVIÇO DE APOIO AO CLIENTE



KR495051 / KR495101

K 1050 TS / K 1050 TST - MÁQ. LAVAR ALTA-PRESSÃO 130 BAR

7.5 Lts/min - 450 Lts/h. 2.2 kW. 23/26 kg.

Acessórios incluídos: Mangueira de alta pressão 8m. Pistola de desconexão de segurança.

Lança com bocal turbo-jet. Lança jato em leque com tubo de aço inoxidável. Filtro de entrada de água.

K1050 series



130 BAR



450 LT/H



2800 RPM



230V

arrumação de acessórios



K 1050 TS

enrolador de mangueira



K 1050 TST



ACESSÓRIOS INCLUÍDOS



Para ver mais acessórios consulte p.56-58.

K 1050 TS
€ **606.⁵⁸**

K 1050 TST
€ **723.⁰⁸**

HD series

KR600030 / KR600080

HD 7/122 TS / HD 10/122 TS MÁQ. LAVAR ALTA-PRESSÃO 120 BAR

7/10 Lts/min - 420/600 Lts/h. 1.6/2.5 kW. 22/23 kg.
 Acessórios incluídos: Mangueira de alta pressão 10 m com malha de aço.
 Pistola de desconexão de segurança. Lança com bocal turbo-jet com tubo de aço inoxidável. Lança de aço inoxidável com bocal de jato em leque.

120 BAR	120 BAR
420 LT/H	600 LT/H
1400 RPM	2800 RPM
230V	230V

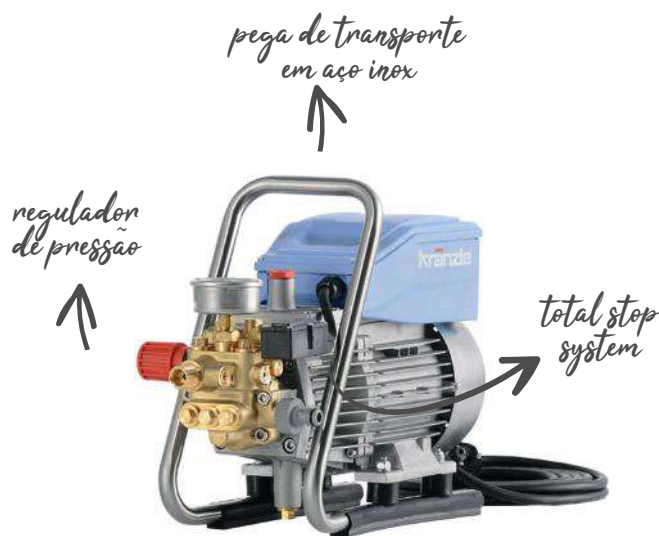

ACESSÓRIOS INCLuíDOS



HD 7/122 TS

€ **802.²⁰**

HD 7/122 TS
 HD 10/122 TS

HD 10/122 TS

€ **802.²⁰**

KR602010 / KR602020

K 1152 TS / K 1152 TST - MÁQ. LAVAR ALTA-PRESSÃO 130 BAR

10 Lts/min - 600 Lts/h. 2.8 kW. 28/30 kg.
 Acessórios incluídos: Mangueira de alta pressão 10m (TS) /15m (TST) com malha de aço. Pistola de desconexão de segurança. Lança com bocal turbo-jet com tubo de aço inoxidável. Lança vario-jet duo com tubo de aço inoxidável.

K1152 series

130 BAR
600 LT/H
2800 RPM
230V

arrumação de acessórios



K 1152 TS

enrolador de mangueira



rodas robustas



K 1152 TST



ACESSÓRIOS INCLuíDOS



K 1152 TS

€ **923.⁰⁸**

K 1152 TST

€ **987.⁹¹**

KR604010 / KR604020

K 2160 TS / K 2160 TST - MÁQ.LAVAR ALTA-PRESSÃO 140 BAR

11 Lts/min - 660 Lts/h. 3.2 kW. 39/40 Kg.

Acessórios incluídos: Mangueira de alta pressão 10m (TS) / 15m (TST) com malha de aço. Pistola de desconexão de segurança. Lança com bocal turbo-jet com tubo de aço inoxidável. Lança vario-jet duo com tubo de aço inoxidável.

K2000 series



medidor de pressão de aço inox

armazenamento de acessórios

enrolador de mangueira

K 2160 TS

€ 1181.³²

K 2160 TST

€ 1314.²⁹

K 2160 TS

K 2160 TST

ACESSÓRIOS INCLuíDOS



KR604050 / KR604060

K 2195 TS / K 2195 TST - MÁQ.LAVAR ALTA-PRESSÃO 170 BAR

8 Lts/min - 480 Lts/h. 3.2 kW. 39/40 Kg.

Acessórios incluídos: Mangueira de alta pressão 10m (TS) / 15m (TST) com malha de aço. Pistola de desconexão de segurança. Lança com bocal turbo-jet com tubo de aço inoxidável. Lança vario-jet duo com tubo de aço inoxidável.

K2000 series



medidor de pressão de aço inox

armazenamento de acessórios

enrolador de mangueira

K 2195 TS

€ 1181.³²

K 2195 TST

€ 1314.²⁹

K 2195 TS

K 2195 TST

ACESSÓRIOS INCLuíDOS















KR606000 / KR606010 / KR606100

PROFI 160 TST / 195 TST / 175 TST - MÁQ.LAVAR ALTA PRESSÃO 140/170/150 BAR

11/8/12 Lts/min. 660/480/720Lts/h. 3.2/3.8 kW. 45 Kg.

Acessórios incluídos: Mangueira de alta pressão 15m com malha de aço. Pistola de desconexão de segurança. Lança com bocal turbo-jet com tubo de aço inoxidável. Lança de aço inoxidável com bocal de jato em leque.

 140 BAR	 170 BAR	 150 BAR
 660 LT/H	 480 LT/H	 720 LT/H
 1400 RPM	 1400 RPM	 1400 RPM
 230V	 230V	 400V

medidor de pressão de aço inox

depósito de água integrado

armazenamento de acessórios

enrolador de mangueira



PROFI 160 TST

PROFI 160 TST

€ **1501.⁰⁹**

PROFI 195 TST

€ **1501.⁰⁹**

PROFI 175 TST

€ **1545.⁰⁵**



ACESSÓRIOS INCLuíDOS











KR608000 / KR608020

QUADRO 11/140 TST / 9/170 TST - MÁQ.LAVAR ALTA-PRESSÃO 140/170 BAR

11/9 Lts/min. 660/540 Lts/h. 3.3 kW. 47 Kg.

Acessórios incluídos: Mangueira de alta pressão 15m com malha de aço. Pistola de desconexão de segurança. Lança com bocal turbo-jet com tubo de aço inoxidável. Lança de aço inoxidável com bocal de jato em leque.

 140 BAR	 170 BAR
 660 LT/H	 540 LT/H
 1400 RPM	 1400 RPM
 230V	 230V

depósito de água integrado

regulador de pressão

proteção contra impactos

enrolador de mangueira

armazenamento de acessórios

total-stop system



QUADRO 11/140 TST
QUADRO 9/170 TST

QUADRO 11/140 TST

€ **1495.⁶⁰**

QUADRO 9/170 TST

€ **1495.⁶⁰**

Quadro series small



ACESSÓRIOS INCLuíDOS



KR610000 / KR610100 / KR610120
QUADRO 599 TST / 799 TST / 899 TST - MÁQ. LAVAR ALTA-PRESSÃO 150/180/150 BAR
 10/13/15 Lts/min. 600/780/900 Lts/h. 63 Kg
 Acessórios incluídos: Mangueira de alta pressão 20m com malha de aço. Pistola de desconexão de segurança. Lança com bocal turbo-jet com tubo de aço inoxidável. Lança de aço inoxidável com bocal de jato em leque.

150 BAR	180 BAR	150 BAR
600 LT/H	780 LT/H	900 LT/H
1400 RPM	1400 RPM	1400 RPM
230V	400V	400V



QUADRO 599 TST
€ 1676.⁹²

QUADRO 799 TST
€ 1850.⁵⁵

QUADRO 899 TST
€ 1928.⁵⁷

QUADRO 11/140 TST
 QUADRO 9/170 TST

Quadro series

medium



ACESSÓRIOS INCLuíDOS



KR612080 / KR612110
QUADRO 1000 TS / 1200 TS - MÁQ. LAVAR ALTA-PRESSÃO 220/180 BAR
 16/19 Lts/min. 960/1140 Lts/h. 7.5 kW. 83 Kg
 Acessórios incluídos: Mangueira de alta pressão 10m com malha de aço. Pistola de desconexão de segurança. Lança com bocal rotativo turbo com tubo de aço inoxidável. Lança de aço inoxidável com bocal de jato em leque.

220 BAR	180 BAR
960 LT/H	1140 LT/H
1400 RPM	1400 RPM
400V	400V



QUADRO 1000 TS
€ 2312.⁰⁹

QUADRO 1200 TS
€ 2312.⁰⁹

QUADRO 1000 TS
 QUADRO 1200 TS

Quadro series

large

ACESSÓRIOS INCLuíDOS



KR612060 / KR612090 / KR612120

QUADRO 800 TST / 1000 TST / 1200 TST - MÁQ.LAVAR ALTA-PRESSÃO 250/220/180 BAR













13.3/16/19 Lts/min. 800/960/1140 Lts/h. 7.5 kW. 89 Kg.

Acessórios incluídos: Mangueira de alta pressão 20m com malha de aço. Pistola de desconexão de segurança. Lança com bocal rotativo turbo com tubo de aço inoxidável. Lança de aço inoxidável com bocal de jato em leque.

Quadro series

large



 250 BAR	 220 BAR	 180 BAR
 800 LT/H	 960 LT/H	 1140 LT/H
 1400 RPM	 1400 RPM	 1400 RPM
 400V	 400V	 400V

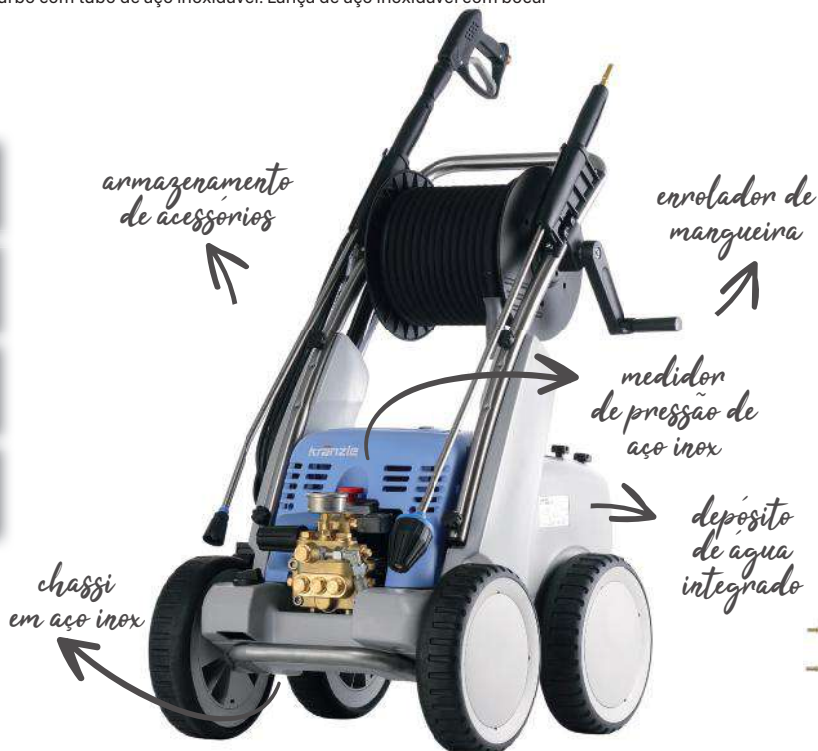

QUADRO 1000 TST

ACESSÓRIOS INCLuíDOS



QUADRO 800 TST

€ **2606.58**

QUADRO 1000 TST

€ **2606.58**

QUADRO 1200 TST

€ **2606.58**

KR618003 / KR618007 / KR618023 / KR618027







PROFI-JET B13/150 / PROFI-JET B10/200 - MÁQ.LAVAR ALTA-PRESSÃO 150/200 BAR

13/10 Lts/min. 780/600 Lts/h. 42/50 Kg.

Acessórios incluídos: Mangueira de alta pressão 10m / 20m (com enrolador) com malha de aço. Pistola de desconexão de segurança. Lança com bocal turbo-jet com tubo de aço inoxidável. Lança de aço inoxidável com bocal regulador. Filtro de entrada de água.

Profi-Jet series



 150 BAR	 200 BAR
 780 LT/H	 600 LT/H
 HONDA GX160 LX	 HONDA GX200 LX



ACESSÓRIOS INCLuíDOS



PROFI-JET B 13/150 (S/ ENROLADOR)

€ **2376.92**

PROFI-JET B 10/200 (S/ ENROLADOR)

€ **2469.23**

PROFI-JET B 13/150 (C/ ENROLADOR)

€ **2651.65**

PROFI-JET B 10/200 (C/ ENROLADOR)

€ **2743.95**

KR618045 / KR618049

PROFI-JET B16/220 - MÁQ.LAVAR ALTA-PRESSÃO 220 BAR

16 Lts/min. 960 Lts/h. 65/73 Kg.

Acessórios incluídos: Mangueira de alta pressão 10m / 20m (com enrolador) com malha de aço. Pistola de desconexão de segurança. Lança com bocal rotativo turbo com tubo de aço inoxidável. Lança de aço inoxidável com bocal regulador. Filtro de entrada de água.

Profi-Jet series



ACESSÓRIOS INCLUÍDOS



PROFI-JET B 16/220 (S/ ENROLADOR)

€ **3653.⁸⁵**

PROFI-JET B 16/220 (C/ ENROLADOR)

€ **3921.⁹⁸**

PROFI-JET B16/220
(S/ ENROLADOR)

KR620001 / KR620023 / KR620033

B 170T / B 240T / B 270T - MÁQ.LAVAR ALTA-PRESSÃO 150/220/250 BAR

12.5/16/16 Lts/min. 750/960 Lts/h. 67/92 Kg.

Acessórios incluídos: Mangueira de alta pressão 20m com malha de aço. Pistola de desconexão de segurança. Lança com bocal turbo-jet com tubo de aço inoxidável (B 170T). Lança com bocal rotativo turbo com tubo de aço inoxidável. (B 240T/B270T). Lança de aço inoxidável com bocal regulador. Filtro de entrada de água.

B series

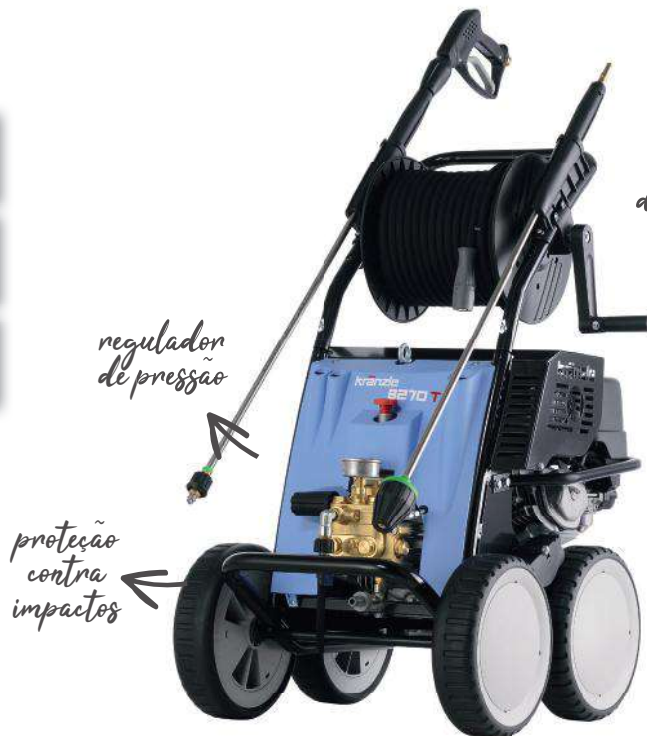
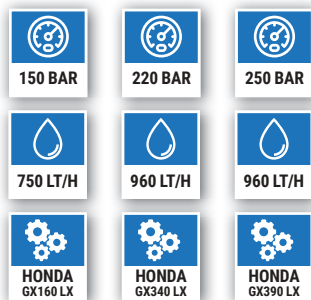

enrolador de mangueira

regulador de pressão

proteção contra impactos

ACESSÓRIOS INCLUÍDOS



B 170 T

€ **2769.²³**

B 240 T

€ **4197.⁸⁰**

B 270 T

€ **4423.⁰⁸**

B 270 T



KR628210

THERM C 13/180 - MÁQ.LAVAR ALTA-PRESSÃO 180 BAR

13 Lts/min. 780 Lts/h. 169 Kg.

Acessórios incluídos: Mangueira de alta pressão 15m com malha de aço. Pistola de desconexão de segurança. Lança de aço inoxidável com bocal de jato em leque. Filtro de entrada de água.

Therm C series*



THERM C 13/180

ACESSÓRIOS INCLUÍDOS



THERM C 13/180

€ **4572.52**

KR632210

THERM 1017- MÁQ.LAVAR ALTA-PRESSÃO 150 BAR

16.7 Lts/min. 1000 Lts/h. 198 Kg.

Acessórios incluídos: Mangueira de alta pressão 20m com malha de aço. Pistola de desconexão de segurança. Lança de aço inoxidável com bocal de jato em leque. Filtro de entrada de água.

Therm 1017 series*



THERM 1017

ACESSÓRIOS INCLUÍDOS



THERM 1017

€ **4660.45**

* Lavagem de alta pressão a quente

KR634410

THERM 895-1- MÁQ.LAVAR ALTA-PRESSÃO 195 BAR

14,9 Lts/min. 895 Lts/h. 222 Kg.

Acessórios incluídos: mangueira de alta pressão 20m com malha de aço. Pistola de desconexão de segurança. Lança de aço inoxidável com bocal de jato em leque. Filtro de entrada de água.

Therm 1 series*



enrolador de mangueira

painel de controlo digital com contador de horas

tampas amovíveis

armazenamento de acessórios



ACESSÓRIOS INCLUÍDOS



THERM 895-1

THERM 895-1

€ 5559.³⁴

KR638210

THERM RP1000 TST - MÁQ.LAVAR ALTA-PRESSÃO 200 BAR

16,6 Lts/min. 1000 Lts/h. 218 Kg.

Acessórios incluídos: Mangueira de alta pressão 20m com malha de aço. Pistola de desconexão de segurança. Lança de aço inoxidável com bocal de jato em leque. Filtro de entrada de água.

Therm RP series*



enrolador de mangueira

tampas amovíveis

painel de controlo digital com contador de horas

travão de imobilização

totalmente eléctrico

adequado para a indústria alimentar



ACESSÓRIOS INCLUÍDOS



THERM RP 1000 TST

€ 5753.⁸⁵

* Lavagem de alta pressão a quente

KR603600 / KR603610

X 8/150 TST / X 10/140 TST - MÁQ.LAVAR ALTA-PRESSÃO 150/140 BAR

8/10 Lts/min - 480/600 Lt/h. 2.25/2.95 kW. 33 Kg.

Acessórios incluídos: Mangueira de alta pressão 15 m com malha de aço. Pistola de desconexão de segurança. Lança de aço inoxidável com bocal de jato em leque. Bico rotativo.

NEW

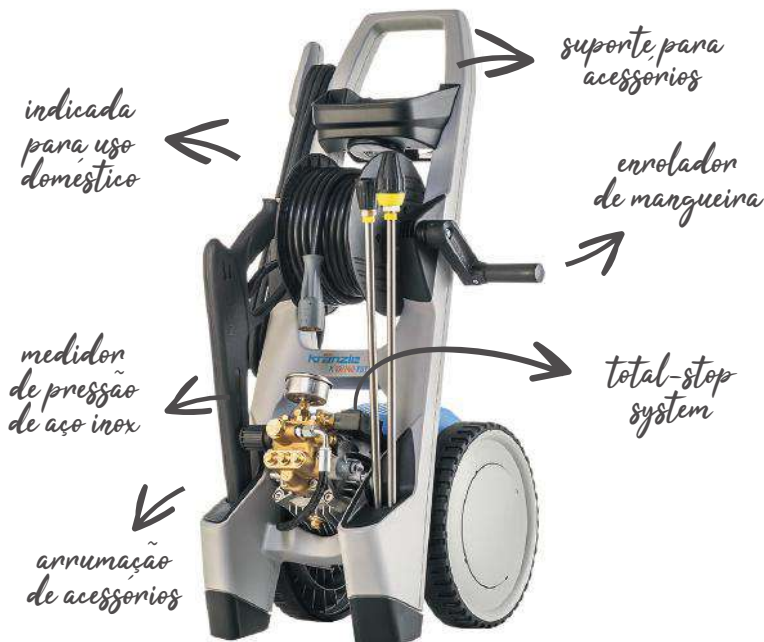
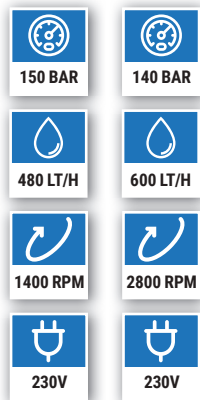

X8/150 TST
€ 1111.25

X10/140 TST
€ 1111.25

X 10/140 TST

ACESSÓRIOS INCLuíDOS



KR622100 / KR622110

WS - RP / WSC-RP 1000 TS - MÁQ.LAVAR ALTA-PRESSÃO 200 BAR

16.6 Lts/min. 1000 Lts/h. 62/65 Kg.

Acessórios incluídos: Mangueira de alta pressão 10m com malha de aço. Pistola de desconexão de segurança. Lança de aço inoxidável com bocal de jato em leque.



WSC - RP 1000 TS

WS-RP 1000 TS (S/ COBERTURA)
€ 2760.45

WSC-RP 1000 TS (C/ COBERTURA)
€ 3392.31

WS - RP 1000 TS

ACESSÓRIOS INCLuíDOS



KR50077

1+1 - VASSOURA MECÂNICA MANUAL

Larg. trabalho - 670mm. Volume recipiente recolha - 30Lts. 24 Kg.

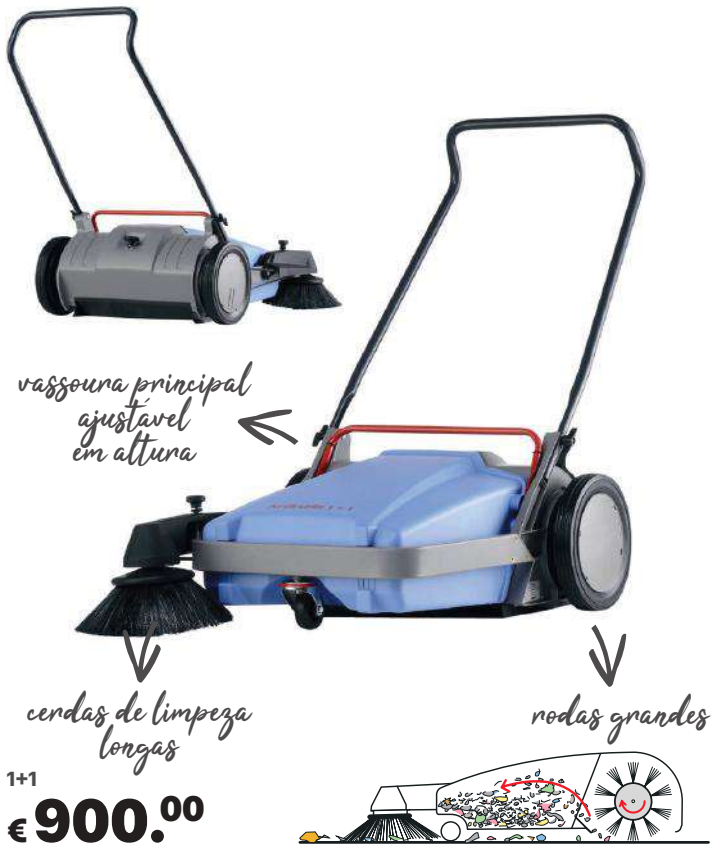

KR50079

COLLY 800 - VASSOURA MECÂNICA MANUAL

Larg. Trabalho - 800mm. Volume recipiente recolha - 30 Lts. 19 Kg.

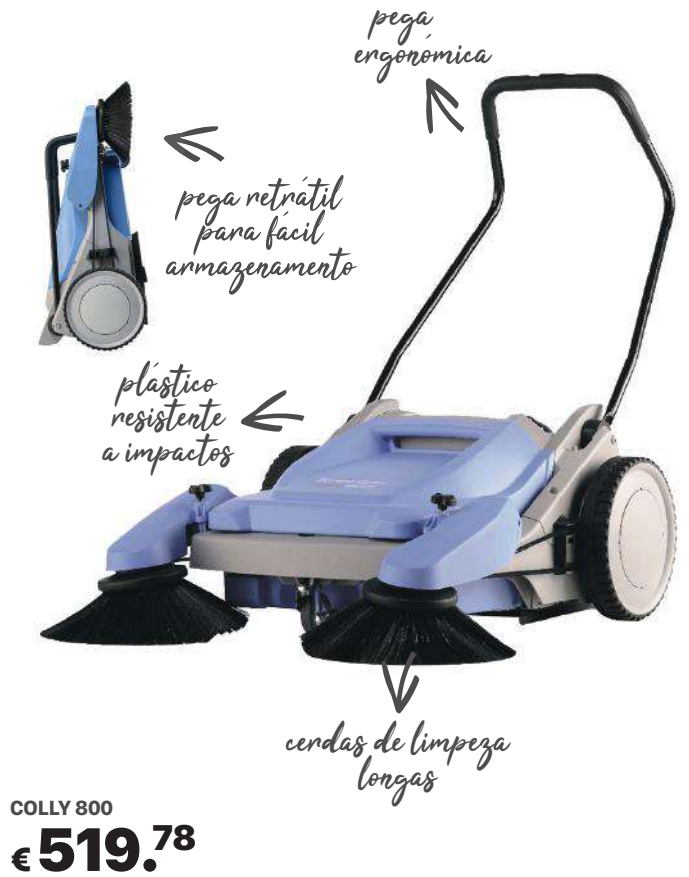

Acessórios



kränzle

© PARA MAIS INFORMAÇÕES TÉCNICAS CONTACTE O NOSSO SERVIÇO DE APOIO AO CLIENTE.

MADE IN GERMANY

práticos, simples e versáteis



1.

2.

1. MANGUEIRA PARA K1050 TS

2. MANGUEIRA STANDARD 10 M

KR410541
8m. DN6. 165 bar.
Polipropileno.

€ 43.68

* para modelo K1050 TS.

KR43416
10m. DN6.
Máx. 210 bar.
Malha de aço.

€ 96.51



3.

3. MANGUEIRA DE LIMPEZA DE TUBOS

KR12850
10m. 160 Bar. 10 Lts/min.
Para limpar tubos, calhas e drenos.

€ 70.55

* para modelos **K1050 TS / TST** e **X-Line A15 / A17 TST**.



4.

4. MANGUEIRA DE LIMPEZA DE TUBOS C/ BOCAL

KR12550
10m. DN5. Máx.200 bar. **€ 118.28**

KR125501
15m. DN5. Máx.200 bar. **€ 144.49**

KR125502
20m. DN5. Máx.200 bar. **€ 174.72**

KR125503
25m. DN5. Máx.200 bar. **€ 209.42**

KR125504
30m. DN5. Máx.200 bar. **€ 259.28**



5.

5. MANGUEIRA DE ASPIRAÇÃO COM FILTRO

KR150383
3m. Ø300mm. 10-12 Lts/Min. 180 Bar. Máx.60°C. **€ 63.31**



6.

6. UNIÃO MANGUEIRA

KR13286
M22 macho. Entrada e saída M22x1.5 AG. **€ 7.80**



7.

7. FILTRO DE ENTRADA DE ÁGUA

KR13310
Entrada 3/4" macho. Saída 3/4" fêmea. **€ 28.63**

KR133003
Entrada 3/4" macho. Saída 3/4" fêmea. **€ 38.05**

* c/ entrada e saída de água em latão.



8.

8. FILTRO DE ENTRADA DE ÁGUA

KR13311
* para modelos **K1050 TS / TST**. **€ 5.65**



9.

9. PISTOLA M2001

KR12475
M22x1.5 AG. Encaixe D10. **€ 96.09**

* para modelos **K1050 TS / TST**.



10.

NEW

10. PISTOLA STARLET 4

KR12525
Máx.20Lt/min. 210 Bar. 100°C. Encaixe D12. **€ 126.20**



11.

NEW



12.



13.



14.

11. PISTOLA STARLET 3 ENCAIXE D12

KR12500
Máx. 40 Lts/min.
270 Bar. 150°C.
Encaixe D12.

€ 117.34

12. INJETOR DE ESPUMA LIGHT

KR135302
1 Lt. Jato ajustável.

€ 95.15

13. INJETOR DE ESPUMA

KR135303
1 Lt. Encaixe D12.

* para modelos X-A15/X-A17 K1050.

€ 117.34

14. LANÇA JATO EM LEQUE PARA K1050

○ **KR12900-03**
Aço Inoxidável. 400mm.
Indicada para remoção de sujidade normal.

€ 39.52

* para modelos K1050 TS / TST.

KR135312
2 Lt. Jato ajustável.

€ 105.91

KR135313
2 Lt. Encaixe D12.

€ 124.06



15.

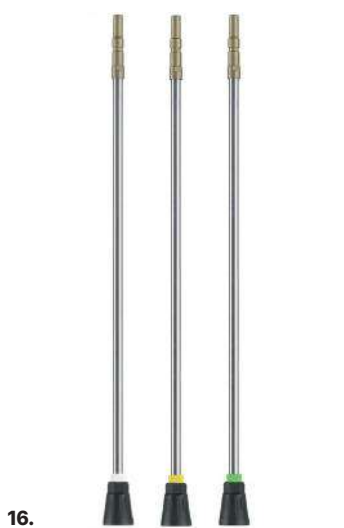

16.



17.

NEW

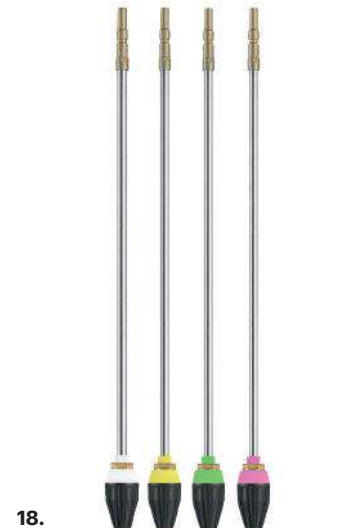

18.

15. LANÇA ROTATIVA PARA K1050

○ **KR42403-03**
Aço Inoxidável.
400mm.
* para modelos K1050 TS / TST.

€ 69.75

16. LANÇA JATO EM LEQUE

○ **KR12435-M2003**
● **KR12435-M20042**
● **KR12435-M20045**
Aço Inoxidável.
500mm. Encaixe D12.

€ 51.75

17. LANÇA COM BOCAL VARIO-JET DUO

○ **KR12433-03**
● **KR12433-042**
Aço Inoxidável.
500mm. Encaixe D12.

€ 60.34

18. LANÇA ROTATIVA TURBO-JET

○ **KR12438-03**
● **KR12438-042**
● **KR12438-045**
● **KR12438-028**
Aço Inoxidável.
500mm. Encaixe D12.

€ 119.09

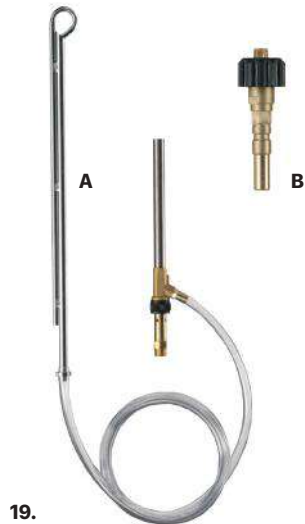

19.

19. KIT DE JATO DE AREIA

A - KR41068
Ideal para jactear arenito e fachadas. Máx.250 bar. Material de jato c/ granulação de 0.2-2mm. Encaixe D12.

€ 151.08

B - KR124415
ADAPTADOR D12 OPCIONAL
M22x1.5 AG. 19 Lt/min. 250 Bar. Material decapante 0.2 - 2mm.

€ 27.82



20.

20. ESCOVA LAVAGEM ROTATIVA

KR12800
Ø180 mm. Comprimento do tubo 210mm. Proteção anti-torção. Para limpeza de entradas, calçadas, terraços e paredes, entre outras aplicações.

€ 66.52

* para modelos K1050 TS / TST.



21.

21. ESCOVA LAVAGEM ROTATIVA UFO PARA K1050

KR41870
Ø260mm.

€ 78.75

* para modelos K1050 TS / TST.



22.

22. ESCOVA DE LAVAGEM ROTATIVA

KR410506
Ø180mm. Prolongamento em aço inoxidável 342mm. Encaixe D12.

€ 80.38

Com proteção contra torção 500mm.



23.

23. LAVADORA ROUND CLEANER UFO

KR41880
Ø300mm. Máx. 12 Lts/min. 180 Bar. Encaixe D12.

€ 188.71

Adequado para pequenas e médias superfícies.



24.

24. DETERGENTE MARINE

KR412731
5 Lts. pH 13.5.

€ 36.95

Produto de limpeza intensivo altamente alcalino que dissolve a fuligem, manchas de óleo e gordura.



25.

25. DETERGENTE NEUTRAL

KR412711
5 Lts. pH 10.9.

€ 36.29

Produto de limpeza universal para remoção de sujidade forte.



26.

26. ÓLEO DE ENGRENAGEM

KR400932
1 Lt.

€ 40.18

Indicado para bombas de alta pressão. Alta performance.



Aspiradores de uso industrial

X15
ASPIRADOR X15
Potência máx. 650W. Fluxo de ar 30 m³/h.
Capacidade 11 Lt. Peso 7.7 Kg.
Acessórios incluídos.

€ **229.²⁹**



X15

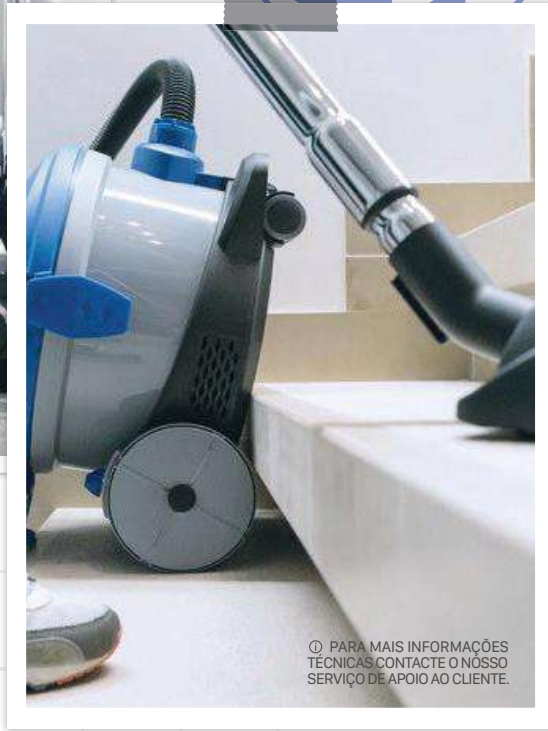

PARA MAIS INFORMAÇÕES TÉCNICAS CONTACTE O NOSSO SERVIÇO DE APOIO AO CLIENTE.

FIX15/10
SACOS P/ ASPIRADOR X15
10 Lt.

€ **33.²¹**



pack 10 unidades

- ▶ Mais de 150 modelos.
- ▶ Sem emissão de CO² no meio ambiente.
- ▶ 50 produtos certificados.
- ▶ Fabricado em Itália.

ESWP110E
ASPIRADOR ESAT
Potência máx. 1250W. Fluxo de ar 258m³/h. Capacidade 21 Lt. Peso 9.3Kg.
Acessórios incluídos.

€ **102.⁸⁷**



MADE IN ITALY

AWI110P
ASPIRADOR ARES PLUS
Potência máx. 1250W. Fluxo de ar 170m³/h.
Capacidade 37Lt. Peso 13.7 Kg.
Acessórios incluídos.

€ **268.⁹³**



QDP125
ASPIRADOR QUIET
Potência máx. 1400W. Fluxo de ar 205 m³/h.
Capacidade 21Lt. Peso 12 Kg.
Acessórios incluídos.

€ **229.²⁹**



ARES PLUS

QUIET

**VMDP125
ASPIRADOR VIBRA 125**
Potência máx.1400W. Fluxo de ar 215m³/h.
Capacidade 37Lt. Peso 12.7Kg. Elétrico.
Acessórios incluídos.

€ **492.⁸⁶**

VIBRA 125



arranque automático



**VMDP125EA
ASPIRADOR VIBRA 125**
Potência máx..1400W. Fluxo de ar 215m³/h.
Capacidade 37Lt. Peso 13Kg. Elétrico/ Pneumático.
Acessórios incluídos.

€ **700.⁷¹**

► Adequado para aspirar serradura seca e poeiras perigosas com valores máximos de concentração ambiente MAK 0,1mg/m³ (classe de poeiras M).



elétrico/pneumático



VIBRA 125M

**KITV040
KIT ACESSÓRIOS
DE ASPIRAÇÃO**

€ **68.⁵⁷**

**EXWP220M / EXWP330M
ASPIRADOR EXEL M**
Potência máx.2400/3300W. Fluxo de ar 340/510 m³/h.
Capacidade 77/76 Lt. Peso 24/25 Kg.
Acessórios incluídos.

tanque em polipropileno



EXEL M

EXWP220M
€ **416.⁷⁹**

EXWP330M
€ **513.²¹**

**EWIV250 / EWIV330
LAVADORA DE ESTOFOS ESTRO 2M/3M**
Potência Max.2600/3300W. Fluxo de ar 430/510 m³/h.
Capacidade 77/76 Lt. Peso 27.5/27.9 Kg.
Acessórios incluídos.



ESTRO

EWIV250
€ **759.⁶⁴**

EWIV330
€ **922.⁵⁰**



**KITW040
KIT ACESSÓRIOS
DE ASPIRAÇÃO**

€ **86.⁷⁹**

**VEWI220 / VEWI330
ASPIRADOR VERSO 2/3**

Potência máx. 2400/3300W. Fluxo de ar 340/510 m³/h.
Capacidade 77/76 Lt. Peso 27/29 Kg.
Acessórios incluídos.

VERSO



VEWI220
€ **534.64**

VEWI330
€ **621.43**

**SWP110
ASPIRADOR/VAPORIZADOR STEAM WAVE**

Potência máx. 1250W. Capacidade caldeira 2.2 Lt. Pressão trabalho 6 Bar. Produção vapor 3.5 kg/h. Temperatura Vapor 160°. Tanque água 8Lt. Capacidade 22 Lt. Peso 22 Kg. Acessórios incluídos.



STEAM WAVE

SWP110
€ **1260.00**

**ELWIB250EA
ASPIRADOR ELECT 250B**

Potência máx. 2600W. Fluxo de ar 430 m³/h.
Capacidade 77 Lt. Peso 25.9 Kg. Elétrico/ Pneumático.
Acessórios incluídos.



ELECT 250B

ELWIB250EA
€ **813.00**

**SWI125N
ASPIRADOR/VAPORIZADOR STEAM PLUS**

Potência máx. 1400W. Capacidade caldeira 3,5Lt. Pressão trabalho 8 Bar. Produção vapor 5.22 kg/h. Temperatura Vapor 160°. Tanque água/detergente 5Lt. Capacidade 22 Lt. Peso 45 Kg. Acessórios incluídos.



SWI125N
€ **2489.00**

STEAM PLUS

► Ideal para a limpeza e higienização completa de todos os ambientes de trabalho profissionais, sujeitos às normas HACCP.

**BL175ES / BL175EAS
ASPIRADOR MIZAR**

Potência máx. 1700/1700W. Fluxo de ar 230/230 m³/h.
Capacidade 35/35 Lt. Peso 40/41 Kg. Elétrico/ Elétrico/ Pneumático.
Acessórios incluídos.



arranque automático

NEW

uso industrial

BL175ES

€ **671.00**

MIZAR

BL175EAS

€ **837.00**

EWIV375POS

ASPIRADOR DE CARPETES A QUENTE HOT POSEIDON

Potência máx. 3600W. Potência caldeira 1800W. Fluxo de ar 645 m³/h.
Capacidade 60 Lt. Tanque detergente 30Lt. Peso 41 Kg.
Acessórios incluídos.

€ **2011.00**



uso industrial

NEW

HOT
POSEIDON

tanque em aço inoxidável

adequado para lavagem de carros

LAUB1000C

LAVADORA DE PAVIMENTOS INDUSTRIAL LAUB

Potência 1900W. Ø Escova 520/560mm. Motor de aspiração 1x500W.
Motor da escova 2x400W. Diâmetro da escova 2x405mm.
Tanque de recolha/solução 160/145 Lt. Largura de trabalho 750/1000mm.
Dimensões 1470x810x1345mm. Peso 350 Kg.

robusta e de fácil utilização

assento ergonómico

NEW

LAUB

rodo em formato de V e em ângulo de 140°, o que permite uma recolha com maior rapidez e eficácia





autonomia de trabalho 3/4h



velocidade da escova 130 rpm

tração na roda da frente

outras cores disponíveis:

			
Preto P106 P87870	Vermelho P611 P648	Verde P657A20 P87870	Amarelo P134A70 P87870

LAUB1000C

€ **10491.00**

**ZLA52T / ZLA56T
 LAVADORA DE PAVIMENTO INDUSTRIAL**

Potência 24V. Ø Escova 520/560mm. Motor de aspiração 600W. Motor da escova 200W. Tanque de recolha/solução 60/100 Lt. Largura de trabalho 520/560mm. Largura de rodo 700/850mm. Dimensões 1310x520x1100mm. Acessórios incluídos.

**STAINLESS
 STEEL
 304**

- ▶ Chassis e parte mecânica - Aço 304.
- ▶ Sinal de travagem e sinal de anomalia de bateria.
- ▶ Sinal de descarga de bateria.
- ▶ Motor de filtro de ar.
- ▶ Filtro de tanque de água limpa.
- ▶ Válvula elétrica de detergente.
- ▶ Nível de detergente.
- ▶ Flutuador de retenção de solução p/ tanque de recuperação.
- ▶ Regulador de pressão de escova.
- ▶ Barra de sucção inox 304 c/ lâminas de poliuretano.
- ▶ Porta-luvas.



☎ PARA MAIS INFORMAÇÕES TÉCNICAS CONTACTE O NOSSO SERVIÇO DE APOIO AO CLIENTE.

ZLA52T
€ 5408.⁵⁷
ZLA56T
€ 5468.⁵⁷

com tração eletrónica frente - trás

escova única

velocidade da escova 185 rpm

ZLA40C
LAVADORA DE PAVIMENTO INDUSTRIAL

Potência 230V. Ø escova 700mm. Motor de aspiração 600W. Motor da escova 450W. Tanque de recolha/solução 45/35 Lt. Largura de trabalho 400mm. Dimensões 1100x450x1000mm. Peso 48 Kg. Cabo de alimentação 20 Mt. Acessórios incluídos.

**STAINLESS
 STEEL
 304**

- ▶ Chassis e parte mecânica - Aço 304.
- ▶ Tração Mecânica.
- ▶ Sinal de travagem e sinal de anomalia de bateria.
- ▶ Sinal de descarga de bateria.
- ▶ Sinal de tanque de recolha cheio.
- ▶ Válvula elétrica de detergente.
- ▶ Nível de detergente.
- ▶ Flutuador p/ tanque de recuperação.
- ▶ Regulador de pressão de escova.
- ▶ Escova em polipropileno.
- ▶ Regulador de altura.

ZLA40C
€ 3163.⁹³
MADE IN ITALY

Aspiradores e Lavadoras

► Limpe revestimentos, decks, cimento, pavimentos e muito mais com as lavadoras e aspiradores STANLEY®.



© PARA MAIS INFORMAÇÕES TÉCNICAS CONTACTE O NOSSO SERVIÇO DE APOIO AO CLIENTE.



SXVC20PTE / SXVC35PTDE

ASPIRADOR DE SÓLIDOS E LÍQUIDOS 1200W / 1600W

Tanque 20/35 Lts. Fluxo de ar 28/39 Lts. Pressão 17,0/19,0 kPa/mbar. Cabo alimentação 5 Mts. Diâmetro Acess. Ø 35mm. 10 /14,3 Kg. Acessórios incluídos: Mangueira de sucção flexível 2 Mts / Ponteira aspiração cantos / Ponteira de Aspiração tapetes e estofos / Ponta de aspiração Wet&Dry para chão / Extensão alumínio 3x300mm / Filtro HEPA / Filtro de papel / Adaptador de potência.

SXVC30XTDE / SXVC50XTDE

ASPIRADOR DE SÓLIDOS E LÍQUIDOS 1600W / 1600W

Tanque 30/50 Lts. Fluxo de ar 36,5/39 Lts. Pressão 17,0/19,0 kPa/mbar. Cabo alimentação 5 Mts. Diâmetro Acess. Ø 35mm. 10 /14,3/12,5/18,75 Kg. Acessórios incluídos: Mangueira de sucção flexível 2 Mts / Ponteira aspiração cantos / Ponteira de Aspiração tapetes e estofos / Ponta de aspiração Wet&Dry para chão / Extensão alumínio 3x300mm / Filtro HEPA / Filtro de papel / Adaptador de potência.

ACESSÓRIOS INCLUÍDOS



SXVC20PTE
€ 110.³¹

SXVC35PTDE
€ 163.³⁵

AÇÃO WET&DRY

ACESSÓRIOS INCLUÍDOS



SXVC30XTDE
€ 142.¹⁴

SXVC50XTDE
€ 232.²⁴

AÇÃO WET&DRY

**SXPW18PE
LAVADORA ALTA PRESSÃO 135 BAR**

Monofásica. 440 Lts/h. 11 Kg.
Acessórios incluídos: Pistola com segurança / Kit ponteira jato ajustável / Lança extensível / Ponteira jato rotativa / Mangueira 6 Mts / Kit lança de espuma.

ACESSÓRIOS INCLUIDOS



€157.⁴³

**SXPW22DSS
LAVADORA ALTA PRESSÃO 160 BAR**

Monofásica. 460 Lts/h. 13 Kg.
Acessórios incluídos: Pistola com segurança / Kit ponteira jato ajustável / Lança extensível / Ponteira jacto rotativa / Mangueira 8 Mts / Kit lança de espuma.

ACESSÓRIOS INCLUIDOS



€169.⁹⁴

**SXFPW21ME
LAVADORA ALTA PRESSÃO 145 BAR**

Monofásica. 450 Lts/h. 18.1 Kg.
Acessórios incluídos: Pistola com segurança / Kit ponteira jato ajustável / Lança extensível / Ponteira jacto rotativa / Mangueira reforçada PU 8Mts / Kit lança de espuma.

ACESSÓRIOS INCLUIDOS



€263.⁵⁰

**STANLEY
FATMAX**

**SXFPW25E / SXFPW30E
LAVADORA ALTA PRESSÃO FATMAX 150/160 BAR**

Monofásica. 450 / 600 Lts/h. 28 / 30 Kg.
Acessórios incluídos: Pistola com segurança / Kit ponteira jato ajustável / Kit ponteira jacto rotativa / Mangueira reforçada de 10/12Mts.

ACESSÓRIOS INCLUIDOS



SXFPW25E
€388.⁵⁶

SXFPW30E
€502.⁴⁴

**STANLEY
FATMAX**

Ferramentas profissionais



© PARA MAIS INFORMAÇÕES TÉCNICAS CONTACTE O NOSSO SERVIÇO DE APOIO AO CLIENTE.

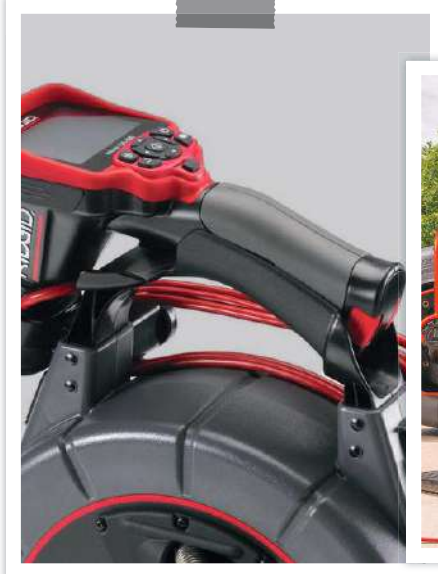

BUILT FOR THOSE WHO
KNOW[®]



RIDGID[®]



↙
40%
mais leve

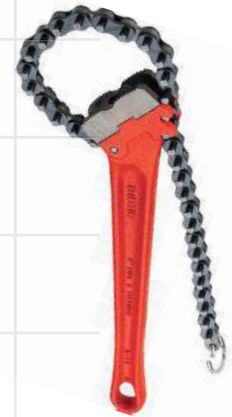

1. Corpo em ferro fundido resistente e pega com viga I. Mordente do gancho com eixo flutuante e rosca de limpeza automática. Mordente gancho e mordente da pega substituíveis.

2. Força profissional em alumínio leve. Oferece a mesma durabilidade e facilidade de utilização encontradas em todas as chaves reforçadas RIDGID.

3. A correia proporciona a máxima aderência e minimiza as marcas.

4. Obs: Mordentes duplos permitem uma acção tipo roquete nas duas direcções. Mordentes substituíveis.

1. CHAVE RECTA HEAVY-DUTY

2. CHAVE RECTA DE ALUMÍNIO

3. PUNHO DE CINTA STRAPLOCK

4. CHAVE DE CORRENTE

RID31010 Modelo 10" € 50.72

RID31090 Modelo 810-10" € 66.02

RID31020 Modelo 14" € 66.49

RID31095 Modelo 814-14" € 84.11

RID31025 Modelo 18" € 86.58

RID31100 Modelo 818-18" € 108.19

RID31030 Modelo 24" € 136.60

RID31105 Modelo 824-24" € 171.04

RID42478 Indicado para tubos de plástico ou PVC de 80-220mm (3"-8"). € 48.91

RID31315 Modelo C-14 - 125mm € 113.36

5.
5. CHAVE DE PEGA DUPLA
RID19261
S-½" 245 mm **€ 39.85**
RID19271
S-1" 320 mm **€ 45.77**
RID19281
S-1 ½" 415 mm **€ 63.47**
RID19291
S-2" 245 mm **€ 96.30**
RID19301
S-3" 320 mm **€ 168.82**

6.
6. CHAVE DE LAVATÓRIO TELESCÓPICA 2017
RID46753
Pega "T" que permite acesso fácil a espaços mais apertados. Inclui LED à prova de água, que fornece iluminação directa do local de trabalho **€ 83.81**

Obs: Design do corpo permite acção telescópica sem esforço a partir de 12" a 17".

7.
7. CHAVE DE ALUMÍNIO RAPIDGRIP®
RID12693
Modelo 14". **€ 80.83**

Obs: 35% mais leve do que modelos reforçados. Para aplicações em locais altos.

RID12698
Modelo 14". **€ 113.59**

Obs: 35% mais leve do que modelos reforçados. Para aplicações em locais altos.

8.
8. CORTA-TUBOS 101
RID40617
6-28mm. **€ 36.96**

Obs: Concebido para uso em espaços reduzidos. Inclui roda de corte extra.

9.
9. CORTA-TUBOS 150L
RID66737
6-35 mm, para cobre e alumínio. **€ 56.19**

Obs: Inclui lâmina de reposição.

10.
10. CORTA-TUBOS INOX
RID29963
Modelo 35S. 6-35mm. **€ 82.95**

Obs: Concebidos exclusivamente para aço inoxidável.

RID31803
Modelo 65S. 6-65mm. **€ 128.07**

Obs: Concebidos exclusivamente para aço inoxidável.

11.
11. TESOURA PC-1250
RID23488
3-42 mm, Para tubagem de plástico (PVC, CPVC, PP, PEX, PE) e multicamada. **€ 35.02**

Obs: Inclui lâmina reversível.

12.
12. TESOURA RC-1625
RID23498
3-42 mm. Para tubagem PEX, PE, PB, PVC, CPVC e multicamada. **€ 72.84**

Obs: Substituição rápida e fácil da lâmina.



13.



14.



15.



16.

12. TESOURA RC-2375

RID30088

12-63 mm. Para tubagem PEX, PE, PB, PVC, CPVC e multicamada.

€ 134.66

Obs: Substituição rápida e fácil da lâmina.

13. ROQUETES DE CURVAMENTO MODELO 326

RID19061

Com matrizes cobre de 3/8", 1/2", 5/8", 3/4", 7/8".

€ 387.31

RID18741

Com matrizes cobre de 10, 12, 14, 15, 16, 18, 22 mm.

€ 388.73

RID35861

Com matrizes cobre de 16, 20, 25, 26, 32 mm.

€ 439.99

14. LASER DE LINHA TRANSVERSAL DE AUTO-NIVELAMENTO MICROCL-100

RID38758

Fornecido em caixa de plástico com tripé grátis.

€ 139.21

Obs: pode ser utilizado em interiores com um alcance até 3mt.

15. DETECTOR DE GASES COMBUSTÍVEIS MICRO CD-100

RID36163

Para detectar metano, propano, muitos outros gases combustíveis.

€ 129.27

Obs: 3 modos de detecção.



17.



18.



19.



20.

16. MEDIDOR DE HUMIDADE E TEMPERATURA MICRO HM-100

RID37438

Mede temperatura, humidade, ponto de orvalho, bulbo húmido. Ecrã duplo LCD com iluminação. Intervalo de humidade de 0% a 100% RH. Intervalo de temperatura 30°-100°C.

€ 129.27

Obs: Ecrã duplo LCD com iluminação.

17. MULTÍMETRO DIGITAL MICRO DM-100

RID37423

Carcça dupla à prova de água (1m) IP-67. Funções True RMS e alcance automático. 11 funções diferentes eléctricas desde tensão e corrente CA/CC (1000V) a medições de temperatura. Classificado para utilização industrial (CAT III-1000V & IV-600V).

€ 129.27

Obs: Ecrã LCD com iluminação.

18. PINÇA AMPERIMÉTRICA DIGITAL MICRO CM-100

RID37428

Funções de True RMS e Alcance automático. Capacidade para cabos de 30 mm de diâmetro exterior e medição de corrente até 1000A CA/CC. Utilizar como multimetro em 8 funções.

€ 129.27

Obs: Ecrã LCD com iluminação

19. TERMÓMETRO INFRAVERMELHOS MICRO IR-200

RID36798

Leituras de temperatura simples, rápidas e precisas da superfície com o premir de um botão. Visor com iluminação de fundo que pode ser regulado em áreas com visibilidade reduzida. Duplo Laser, Classe II. Precisão 1° C.

€ 129.27



21.



22.



23.



24.

tanque com capacidade 13L

20. CÂMARA DE INSPECÇÃO MICRO CA-25

RID40043
Alcance de cabo 120 cm. Cabeça de câmara de alumínio. Ecrã LCD a cores 2,4". Rotação de imagem 180°. Saída de vídeo.

€ 148.91

Obs: Não permite prolongamentos

21. CÂMARA DE INSPECÇÃO MICRO CA-150

RID36848
Visor: LCD a cores 3.5". Cabeça da câmara: Alumínio, 17 mm. 4 LEDs, Ajustáveis. Alcance do cabo: 90 cm (Expansível até 9 mt c/ extensões opcionais). A Prova de água: Cabeça de câmara e cabo até 3mt.

€ 295.12

Obs: Capture até 20 imagens fixas...inspeções para reprodução no visor mais tarde.

22. CÂMARA DE INSPECÇÃO MICRO CA-350X

RID63888
Ecrã 3.5" a cores TFT (Resolução: 320x240). Ø câmara 17 mm, com 4 LEDs ajustáveis. Cabeça da câmara robusta em alumínio com 90 cm (extensível c/ cabos opcionais até 9 mt).
• Bateria lítio 12V avançada e carregador.

€ 788.38



23. BOMBA DE TESTE MODELO 1450

RID50072
Mantém a pressão automaticamente para sistemas HVAC.
• Volume por movimento, 38 cm³.

€ 419.77

Obs: Tanque com capacidade 13L (água, óleo, etilénoglicol).



25.



26.



poterosa, compacta e versátil

27.

25. DESENTUPIDOR MANUAL KWIK SPIN+

RID57038
Para tubagens de ½" a 1½" (20-50 mm). O cabo é retido positivamente no tambor para evitar a retirada do cabo. AUTOFEED® (avanço) permite que o cabo se alimente automaticamente na tubagem.

€ 76.76

26. DESENTUPIDOR MANUAL POWER SPIN+

RID57043
Para operação com aparafusadora até 500 Rpm. Para tubagens de ½" a 1½" (20-50 mm). O cabo é retido positivamente no tambor para evitar a retirada do cabo. AUTOFEED® (avanço) permite que o cabo se alimente automaticamente na tubagem.

€ 97.68

Obs: Cabo Maxcore® resistente a torção.

27. DESENTUPIDORA POWERCLEAR™

RID59143
Desentope, sem esforço, tubos de banheira, chuveiro ou lavatório de ½" (20 mm) a 1½" (40 mm) de diâmetro. Avanço de 2 sentidos. Cabo reforçado com alma interna. Mangueira guia de 2 peças. Pega de transporte. Bujão de drenagem de fácil retirada.

€ 355.51

Obs: Tampa transparente.



28.

28. DESATASCADORA K-45

**RID36033
K-45AF**

Avanço automático de 2 sentidos permite-lhe limpar tubagens até 75 mm. Para canalizações de esgotos de ¾" (20 mm) a 1½" (75 mm).

Inclui: Cabo C-1 IC-8 mmx7,6 mt.

€ 465.45

**RID36043
K-45AF-5**

Avanço automático de 2 sentidos permite-lhe limpar tubagens até 75 mm.

Inclui: Cabo C-1 IC - 8 mm x 7,6 m + Cabo C-6, 10 mmx10,7mt + Jogo T-250 + Mala de transporte.

€ 630.11



29.

29. RANHURADOR DE ROLETES MANUAL MODELO 915

RID88232

Modelo indispensável para trabalho em obra. Capacidade 1¼" - 12". Design ligeiro, 10,4 kg. Punho de transporte de encaixar - fácil de transportar ou trancar para evitar roubos. Roquete incluído - o punho dobrável 90 graus torna a formação de ranhuras mais fácil. Jogos opcionais de roletes 1¼" - 1½" e 8" - 12".

€ 1621.38

Inclui: Conjunto de Roletes de 2" - 6" Sch. 10 (2" - 3 ½" Sch. 40).



30.

Jogo de ferramentas A-61 Jogo de cabos A-25

Broca recta T-101
Broca afunilada T-102
Cortador espada T-107
Broca recuperadora T-125
Cortador c/ dentes de tubarão T-150-1
Caixa de ferramentas
Chave pino A-12.

5 secções de cabos C-8 (16 mm x 2,3 m)
Suporte de cabos A-10.
Broca recta T-201.
Broca afunilada T-202.
Cortador de gordura, "C" T-205.
Chave pino A-13.

30. DESENTUPIDORA K-60SP-SE-A25

RID94497

Para canalizações até 150 mm. Motor de 700 W c/ rotação de 520 rpm.

STANDARD:
Máquina seccional. Luva de protecção RIDGID. Mangueira guia traseira A-60-2. Jogo de cabos A-62. Suporte de cabos A-8. 5 secções de cabos C-10 (22 mmx4,60 mt).

€ 2506.44



31.

31. LIMPADORA DE ALTA PRESSÃO KJ-1590 II

RID35511

Para tubos até 150 mm. Potente motor de 2,2 kW com protecção contra sobrecarga. Bomba 3-pistões com acção por impulsão. Prático armazenamento para o cabo. Conexão com admissão dupla com ligação macho de mangueira para jardim. Filtro de admissão, válvula de retenção e válvula de admissão. Bobina de aço resistente com 20 mt de ligação de mangueira de ¼".

€ 4410.00

adequado para utilização com o ranhurador de rolos ridgid 916, 918 e 975



32.

32. MÁQUINA DE ROSCAR 1233

RID20215

Capacidades: Tubo ¼ - 3" (8-80mm) e 2½ - 4" (65-100 mm) c/ cabeça 141 opcional. Parafuso: 10 - 52 mm até 30 RC. Motor: 1.7kW universal 50 - 60 Hz. Velocidade do eixo: 36 rpm.

STANDARD:

Máquina de roscar, cabeças BSPT de ½" a 2" e de 2 ½" a 3", Caçonetes: ½" a ¾" Liga BSPT 1" - 2" BSPT de alta velocidade de 2½ - 3". Cortador: ¼" - 3", Escareador: ¼" - 3", Óleo: 5 litros.

€ 7469.00

Design leve e portátil

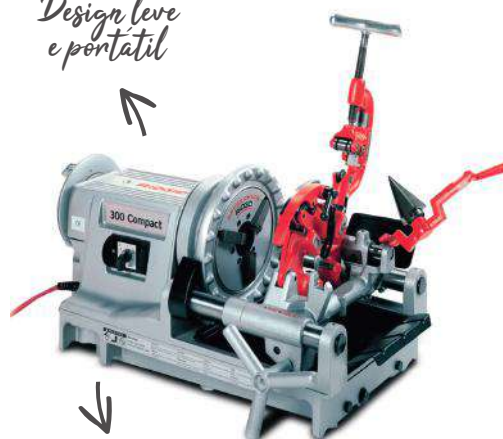

33.

33. MÁQUINA DE ROSCAR 300 COMPACT

RID50697

Capacidades: Tubo: ⅛ - 2" (6 - 50 mm). Parafuso: ¼" - 2" (6 - 52 mm). Motor: 1.7 kW universal 25 - 60 Hz. Velocidade do eixo: 38 rpm.

STANDARD:

Máquina de roscar, cabeças BSPT de ½" a 2", Caçonetes: ½" a ¾" Liga BSPT 1" - 2" BSPT, Cortador: ⅛" a 2", Escareador: ⅛" - 2", Óleo: 5 litros.

€5996.11

funcionamento silencioso



34.

32. ROSCADORA 690-I PARA TUBOS ATÉ 2"

RID44933

Sistema de abertura rápida ajuda a evitar complicações aquando da instalação e remoção das cabeças de roscar (somente na 690-I). Braço de suporte com 2 mordentes para melhor aderência e aumento de segurança durante a operação de roscagem. Pega de mão moldada providencia melhor controlo. Parafuso na tampa das escovas melhora serviço de manutenção.

STANDARD:

Máquina 690-I, Cabeças de roscar s ½", ¾", 1", 1¼", 1½" e 2", braço de suporte, adaptador de cabeça e mala de transporte.

€ 1567.83



35.

35. ROSCADORA 11R

RID13088

Capacidade 11-R: 1/2" - 2". Matrizes de início rápido para um rosqueamento otimizado. Aço de catraca para minimizar a fadiga do utilizador.

€ 950.41

→ não inflamável



36.

36. ÓLEO DE CORTE 5L

RID11931

Isento de cloro e outros halogénios, PCBs e metais pesados. Arrefece as roscas e o tubo durante o funcionamento. Acelera a retirada do metal. Melhora a qualidade da roscagem.

€ 64.66

ideal para uso com aço e inox



39. *leve, compacta e altamente eficiente*

39. MÁQUINA DE DESENTUPIMENTO DE TUBAGENS FLEXSHAFT K9-12

RID76188
Indicado para tubagens de 1 1/4" a 2" (32-50 mm). Ø cabo s/ bainha 1/4" (6mm). Ø cabo c/ bainha 3/8" (9,5 mm). 2500 rpm. Acessório de broca 5/16" Hex (8mm).
€ 514.76

limpeza total da tubagem



40. *uso simultâneo com câmara* *aumento da produtividade*

40. MÁQUINAS DE DESENTUPIMENTO DE TUBAGENS DE ALTA VELOCIDADE FLEXSHAFT

RID64268 K9-102
Limpeza total de tubagens de 1/4" a 4" (32 a 100 mm) até comprimentos de 70' (21,3 m).
€ 1637.74

OBS: Gama completa de correntes e acessórios disponíveis.

RID64278 K9-204
Limpeza total de tubagens de 1/4" a 4" (32 a 100 mm) até comprimentos de 70' (21,3 m).
€ 2412.73

OBS: Gama completa de correntes e acessórios disponíveis.



37. *medição automática de profundidade*

37. LOCALIZADOR SCOUT®

RID19243
O NaviTrack Scout é ideal para os utilizadores localizarem câmaras. SeeSnake e outras sondas que ocasionalmente necessitem de localizar linhas energizadas. Para localizar câmaras e sondas 512 Hz, 640 Hz, 33 KHz.
€ 3095.76

prensagens super rápidas



41. **FERRAMENTA DE CRAVAR MINI RP 115 + MATRIZ U 16-20-25**
RID73898
15kN. Tempo de prensagem 3/4seg. Rotação da cabeça 350°. Capacidade em cobre e em aço (inoxidável) 12-28 mm. Capacidade para multicamada e plástico 12-32 mm. 1.59kg. Bateria de lítio 10,8V-2.5Ah.
€ 1148.00



42. **FERRAMENTA DE CRAVAR RP 219 + MATRIZ U 16-20-25**
RID69108
19kN. Tempo de prensagem 3/4seg. Rotação da cabeça 350°. Capacidade em cobre e em aço (inoxidável) 12-35 mm. Capacidade para multicamada e plástico 12-40 mm. 9.2kg.
€ 1793.93



38. *ultrapassa facilmente curvas de 90° em tubos de 1,5" (40mm)*

38. SEESNAKE® MICRODRAIN APX™ 20M + CAMERA CA350X
RID77593
Indicado para tubagens de 1 1/4" a 3" (32-75 mm). Ø câmara 22mm com rotação da imagem auto, resolução 640x480px. Cabo Alta flexibilidade de 20m. Sonda 512Hz, integrada. Peso 5.25 kg. Tambor Ø 305mm.
€ 5579.00



Equipamento de corte e desbaste

TRUST BLUE



© PARA MAIS INFORMAÇÕES TÉCNICAS CONTACTE O NOSSO SERVIÇO DE APOIO AO CLIENTE.

DISCO CORTE INOX
 Ø 115 cm - Ø 125 cm - Ø 230 cm

4007220560266 EHT 115-1 A60 PSF INOX € 1.84

4007220560372 EHT 125-1 A60 PSF INOX € 2.05

4007220581216 EHT 230-1,9 A46 PSF INOX € 3.44

DISCO DESBASTE
 Ø 115 cm - Ø 125 cm - Ø 230 cm

4007220470510 E 115-7 A30 PS FORTE € 2.87

4007220471142 E 125-7 A30 PS FORTE € 3.38

4007220470541 E 230-7 A30 PS FORTE € 7.21



DISCO CORTE INOX
 Ø 115 cm - Ø 125 cm

4007220499702 EHT 115X1 A60 SG € 2.58

4007220499733 EHT 125X1 A60 SG € 2.92



DISCO POLICLEAN
 Ø 115 cm - Ø 125 cm

4007220515280 PCLD 115-13 € 14.05

4007220515297 PCLD 125-13 € 15.38



DISCO LAMELADO POLIFAN
 Ø 115 cm - Ø 125 cm

4007220013007 PFC 115 Z40 50° ANIVERS. € 2.67

4007220013014 PFC 115 Z60 50° ANIVERS. € 2.67

4007220013021 PFC 115 Z80 50° ANIVERS. € 2.67

4007220013038 PFC 125 Z40 50° ANIVERS. € 2.77

4007220013045 PFC 125 Z60 50° ANIVERS. € 2.77

4007220013052 PFC 125 Z80 50° ANIVERS. € 2.77

4007220048092 EXPOSITOR DE COMPOSIÇÃO MISTA

COMPOSIÇÃO	DESIGNAÇÃO	q
4007220062357	SERRA CRANEANA LS 25 25MM 1"	1un
4007220319130	SERRA CRANEANA LS 40 40MM 1.9/16	1un
4007220062494	SERRA CRANEANA LS 60 60MM 2.3/8	1un
4007220499702	DISCO CORTE METAL PLANO EHT 115-1,0 A60 R SG-INOX/22,23	50un
4007220499733	DISCO CORTE METAL PLANO EHT 125-1,0 A60 R SG-INOX/22,23	50un
4007220926857	CATRABUCHA RBU 75/6,35 AÇO 0,30 SG	2un
4007220926932	CATRABUCHA PBU 24/6 AÇO 0,30 SG	2un
4007220153727	ESCOVA HBG 10 AÇO 0,30 SG	10un
4007220013007	DISCO LAMELADO PFC 115Z 40 -50 ANIVERSARIO	20un
4007220013014	DISCO LAMELADO PFC 115Z 60 -50 ANIVERSARIO	20un
4007220641361	DISCO SEGMENTADO DS 115X22,23 PSF	3un



€ **389.⁰⁸**

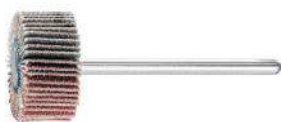

LAMELA DE PERNO ÓXIDO DE ALUMÍNIO

10un

SAP	REF	Mod	*	**	Perno	Grão	PREÇO
4007220336885	F 2010 3 A 60	F	20	10	3	A60	2,10
4007220336892	F 2010 3 A 80	F	20	10	3	A80	2,10
4007220154113	F 2010 3 A 120	F	20	10	3	A120	2,10
4007220154120	F 2010 3 A 150	F	20	10	3	A150	2,10
4007220292563	F 2010 3 A 180	F	20	10	3	A180	2,10
4007220378663	F 2010 3 A 240	F	20	10	3	A240	2,10
4007220378670	F 2010 3 A 320	F	20	10	3	A320	2,10
4007220336885	F 2010 3 A 60	F	20	10	3	A60	2,10
4007220292594	F 2010 6 A 80	F	20	10	6	A80	2,10
4007220292617	F 2010 6 A 120	F	20	10	6	A120	2,10
4007220292624	F 2010 6 A 150	F	20	10	6	A150	2,10
4007220292631	F 2010 6 A 180	F	20	10	6	A180	2,10
4007220536896	F 2510 6 A 80	F	25	10	6	A80	2,27
4007220536902	F 2510 6 A 120	F	25	10	6	A120	2,27
4007220536919	F 2510 6 A 180	F	25	10	6	A180	2,27
4007220154557	F 2515 6 A 80	F	25	15	6	A80	2,29
4007220154564	F 2515 6 A 120	F	25	15	6	A120	2,29
4007220154571	F 2515 6 A 150	F	25	15	6	A150	2,29
4007220292648	F 2515 6 A 180	F	25	15	6	A180	2,29
4007220536926	F 2520 6 A 80	F	25	20	6	A80	2,47
4007220536933	F 2520 6 A 120	F	25	20	6	A120	2,47
4007220536940	F 2520 6 A 180	F	25	20	6	A180	2,47
4007220557440	F 2525 6 A 60	F	25	25	6	A60	2,56
4007220292655	F 2525 6 A 80	F	25	25	6	A80	2,56
4007220292662	F 2525 6 A 120	F	25	25	6	A120	2,56
4007220292679	F 2525 6 A 150	F	25	25	6	A150	2,56
4007220292686	F 2525 6 A 180	F	25	25	6	A180	2,56
4007220950838	F 3003 6 A 80	F	30	3	6	A80	3,23
4007220950845	F 3003 6 A 120	F	30	3	6	A120	3,23
4007220950852	F 3003 6 A 150	F	30	3	6	A150	3,23
4007220950869	F 3003 6 A 180	F	30	3	6	A180	3,23
4007220950876	F 3003 6 A 240	F	30	3	6	A240	3,23
4007220950883	F 3003 6 A 320	F	30	3	6	A320	3,23
4007220154137	F 3005 3 A 60	F	30	5	3	A60	2,00
4007220154151	F 3005 3 A 80	F	30	5	3	A80	2,00
4007220154175	F 3005 3 A 120	F	30	5	3	A120	2,00
4007220154199	F 3005 3 A 150	F	30	5	3	A150	2,00
4007220292693	F 3005 3 A 180	F	30	5	3	A180	2,00
4007220154212	F 3005 3 A 240	F	30	5	3	A240	2,00
4007220154236	F 3005 3 A 320	F	30	5	3	A320	2,00
4007220154144	F 3005 6 A 60	F	30	5	6	A60	2,00
4007220154168	F 3005 6 A 80	F	30	5	6	A80	2,00
4007220154182	F 3005 6 A 120	F	30	5	6	A120	2,00
4007220154205	F 3005 6 A 150	F	30	5	6	A150	2,00
4007220292709	F 3005 6 A 180	F	30	5	6	A180	2,00
4007220154229	F 3005 6 A 240	F	30	5	6	A240	2,00
4007220154243	F 3005 6 A 320	F	30	5	6	A320	2,00
4007220154250	F 3010 3 A 60	F	30	10	3	A60	2,15
4007220154274	F 3010 3 A 80	F	30	10	3	A80	2,15
4007220154298	F 3010 3 A 120	F	30	10	3	A120	2,15
4007220154311	F 3010 3 A 150	F	30	10	3	A150	2,15
4007220292716	F 3010 3 A 180	F	30	10	3	A180	2,15
4007220154335	F 3010 3 A 240	F	30	10	3	A240	2,15
4007220154359	F 3010 3 A 320	F	30	10	3	A320	2,15
4007220154267	F 3010 6 A 60	F	30	10	6	A60	2,15
4007220154281	F 3010 6 A 80	F	30	10	6	A80	2,15
4007220154304	F 3010 6 A 120	F	30	10	6	A120	2,15
4007220154328	F 3010 6 A 150	F	30	10	6	A150	2,15
4007220292723	F 3010 6 A 180	F	30	10	6	A180	2,15
4007220154342	F 3010 6 A 240	F	30	10	6	A240	2,15
4007220154366	F 3010 6 A 320	F	30	10	6	A320	2,15
4007220533017	F 3010 6 A 400	F	30	10	6	A400	2,23
4007220154687	F 3015 6 A 60	F	30	15	6	A60	2,39
4007220154694	F 3015 6 A 80	F	30	15	6	A80	2,39



LAMELA DE PERNO ÓXIDO DE ALUMÍNIO

10un

SAP	REF	Mod	*	**	Perno	Grão	PREÇO
4007220154700	F 3015 6 A 120	F	30	15	6	A120	2,39
4007220154717	F 3015 6 A 150	F	30	15	6	A150	2,39
4007220292730	F 3015 6 A 180	F	30	15	6	A180	2,39
4007220154724	F 3015 6 A 240	F	30	15	6	A240	2,39
4007220154731	F 3015 6 A 320	F	30	15	6	A320	2,39
4007220035153	F 3020 6 A 40	F	30	20	6	A40	2,59
4007220035160	F 3020 6 A 60	F	30	20	6	A60	2,59
4007220035177	F 3020 6 A 150	F	30	20	6	A150	2,59
4007220035184	F 3020 6 A 180	F	30	20	6	A180	2,59
4007220035191	F 3020 6 A 240	F	30	20	6	A240	2,59
4007220035207	F 3020 6 A 320	F	30	20	6	A320	2,59
4007220292747	F 3030 6 A 60	F	30	30	6	A60	2,94
4007220292754	F 3030 6 A 80	F	30	30	6	A80	2,94
4007220292761	F 3030 6 A 120	F	30	30	6	A120	2,94
4007220292778	F 3030 6 A 150	F	30	30	6	A150	2,94
4007220292785	F 3030 6 A 180	F	30	30	6	A180	2,94
4007220292792	F 3030 6 A 240	F	30	30	6	A240	2,94
4007220292808	F 3030 6 A 320	F	30	30	6	A320	2,94
4007220154373	F 4010 6 A 60	F	40	10	6	A60	2,51
4007220154380	F 4010 6 A 80	F	40	10	6	A80	2,51
4007220154403	F 4010 6 A 120	F	40	10	6	A120	2,51
4007220154410	F 4010 6 A 150	F	40	10	6	A150	2,51
4007220292815	F 4010 6 A 180	F	40	10	6	A180	2,51
4007220154427	F 4010 6 A 240	F	40	10	6	A240	2,51
4007220154441	F 4015 6 A 60	F	40	15	6	A60	2,65
4007220154458	F 4015 6 A 80	F	40	15	6	A80	2,65
4007220154465	F 4015 6 A 120	F	40	15	6	A120	2,65
4007220154489	F 4015 6 A 150	F	40	15	6	A150	2,65
4007220292822	F 4015 6 A 180	F	40	15	6	A180	2,65
4007220154496	F 4015 6 A 240	F	40	15	6	A240	2,65
4007220154519	F 4015 6 A 320	F	40	15	6	A320	2,65
4007220800607	F 4020 6 A 40	F	40	20	6	A40	2,93
4007220154625	F 4020 6 A 60	F	40	20	6	A60	2,93
4007220154632	F 4020 6 A 80	F	40	20	6	A80	2,93
4007220154649	F 4020 6 A 120	F	40	20	6	A120	2,93
4007220154656	F 4020 6 A 150	F	40	20	6	A150	2,93
4007220292839	F 4020 6 A 180	F	40	20	6	A180	2,93
4007220154663	F 4020 6 A 240	F	40	20	6	A240	2,93
4007220950968	F 5005 6 A 60	F	50	5	6	A60	2,99
4007220951019	F 5005 6 A 80	F	50	5	6	A80	2,99
4007220951026	F 5005 6 A 120	F	50	5	6	A120	2,99
4007220951033	F 5005 6 A 150	F	50	5	6	A150	2,99
4007220951040	F 5005 6 A 180	F	50	5	6	A180	2,99
4007220951057	F 5005 6 A 240	F	50	5	6	A240	2,99
4007220951064	F 5005 6 A 320	F	50	5	6	A320	2,99
4007220155189	F 5010 6 A 60	F	50	10	6	A60	2,59
4007220155196	F 5010 6 A 80	F	50	10	6	A80	2,59
4007220155202	F 5010 6 A 120	F	50	10	6	A120	2,59
4007220155219	F 5010 6 A 150	F	50	10	6	A150	2,59
4007220292846	F 5010 6 A 180	F	50	10	6	A180	2,59
4007220155226	F 5010 6 A 240	F	50	10	6	A240	2,59
4007220155233	F 5010 6 A 320	F	50	10	6	A320	2,59
4007220155240	F 5015 6 A 60	F	50	15	6	A60	3,17
4007220155257	F 5015 6 A 80	F	50	15	6	A80	3,17
4007220155264	F 5015 6 A 120	F	50	15	6	A120	3,17
4007220155271	F 5015 6 A 150	F	50	15	6	A150	3,17
4007220292853	F 5015 6 A 180	F	50	15	6	A180	3,17
4007220155288	F 5015 6 A 240	F	50	15	6	A240	3,17
4007220155295	F 5015 6 A 320	F	50	15	6	A320	3,17
4007220155127	F 5020 6 A 60	F	50	20	6	A60	3,29
4007220155134	F 5020 6 A 80	F	50	20	6	A80	3,29
4007220155141	F 5020 6 A 120	F	50	20	6	A120	3,29
4007220155158	F 5020 6 A 150	F	50	20	6	A150	3,29
4007220292860	F 5020 6 A 180	F	50	20	6	A180	3,29
4007220155172	F 5020 6 A 320	F	50	20	6	A320	3,29



LAMELA DE PERNO ÓXIDO DE ALUMÍNIO

10un

SAP	REF	Mod	*	**	Perno	Grão	PREÇO
4007220800591	F 5030 6 A 40	F	50	30	6	A40	3,77
4007220155066	F 5030 6 A 60	F	50	30	6	A60	3,77
4007220155073	F 5030 6 A 80	F	50	30	6	A80	3,77
4007220155080	F 5030 6 A 120	F	50	30	6	A120	3,77
4007220155097	F 5030 6 A 150	F	50	30	6	A150	3,77
4007220292877	F 5030 6 A 180	F	50	30	6	A180	3,77
4007220155103	F 5030 6 A 240	F	50	30	6	A240	3,77
4007220155110	F 5030 6 A 320	F	50	30	6	A320	3,77
4007220951071	F 6005/6 A 60	F	60	5	6	A60	3,45
4007220951088	F 6005/6 A 80	F	60	5	6	A80	3,45
4007220951095	F 6005/6 A 120	F	60	5	6	A120	3,45
4007220951101	F 6005/6 A 150	F	60	5	6	A150	3,45
4007220951118	F 6005/6 A 180	F	60	5	6	A180	3,45
4007220951125	F 6005/6 A 240	F	60	5	6	A240	3,45
4007220951132	F 6005/6 A 320	F	60	5	6	A320	3,45
4007220155301	F 6015 6 A 60	F	60	15	6	A60	3,19
4007220155318	F 6015 6 A 80	F	60	15	6	A80	3,19
4007220155325	F 6015 6 A 120	F	60	15	6	A120	3,19
4007220155332	F 6015 6 A 150	F	60	15	6	A150	3,19
4007220155349	F 6015 6 A 240	F	60	15	6	A240	3,19
4007220155356	F 6015 6 A 320	F	60	15	6	A320	3,19
4007220155363	F 6020 6 A 60	F	60	20	6	A60	3,55
4007220155370	F 6020 6 A 80	F	60	20	6	A80	3,55
4007220155387	F 6020 6 A 120	F	60	20	6	A120	3,55
4007220155394	F 6020 6 A 150	F	60	20	6	A150	3,55
4007220292891	F 6020 6 A 180	F	60	20	6	A180	3,55
4007220155400	F 6020 6 A 240	F	60	20	6	A240	3,55
4007220155417	F 6020 6 A 320	F	60	20	6	A320	3,55
4007220155424	F 6030 6 A 40	F	60	30	6	A40	3,93
4007220155431	F 6030 6 A 60	F	60	30	6	A60	3,93
4007220155448	F 6030 6 A 80	F	60	30	6	A80	3,93
4007220155455	F 6030 6 A 120	F	60	30	6	A120	3,93
4007220155462	F 6030 6 A 150	F	60	30	6	A150	3,93
4007220292907	F 6030 6 A 180	F	60	30	6	A180	3,93
4007220155479	F 6030 6 A 240	F	60	30	6	A240	3,93
4007220155486	F 6030 6 A 320	F	60	30	6	A320	3,93
4007220533024	F 6030 6 A 400	F	60	30	6	A400	4,00
4007220155493	F 6040 6 A 60	F	60	40	6	A60	4,67
4007220155509	F 6040 6 A 80	F	60	40	6	A80	4,67
4007220155516	F 6040 6 A 120	F	60	40	6	A120	4,67
4007220155523	F 6040 6 A 150	F	60	40	6	A150	4,67
4007220155530	F 6040 6 A 240	F	60	40	6	A240	4,67
4007220155554	F 6050 6 A 40	F	60	50	6	A40	5,41
4007220155561	F 6050 6 A 60	F	60	50	6	A60	5,41
4007220155578	F 6050 6 A 80	F	60	50	6	A80	5,41
4007220155585	F 6050 6 A 120	F	60	50	6	A120	5,41
4007220155592	F 6050 6 A 150	F	60	50	6	A150	5,41
4007220155608	F 6050 6 A 240	F	60	50	6	A240	5,41
4007220155615	F 6050 6 A 320	F	60	50	6	A320	5,41
4007220549780	F 8005 6 A 60	F	80	5	6	A60	4,18
4007220373743	F 8005 6 A 80	F	80	5	6	A80	4,18
4007220463062	F 8005 6 A 120	F	80	5	6	A120	4,18
4007220403396	F 8005 6 A 150	F	80	5	6	A150	4,18
4007220958889	F 8005 6 A 180	F	80	5	6	A180	4,18
4007220102114	F 8005 6 A 240	F	80	5	6	A240	4,18
4007220102121	F 8005 6 A 320	F	80	5	6	A320	4,18
4007220422120	F 8010 6 A 60	F	80	10	6	A60	3,71
4007220262184	F 8010 6 A 80	F	80	10	6	A80	3,71
4007220422137	F 8010 6 A120	F	80	10	6	A120	3,71
4007220065877	F 8010 6 A 150	F	80	10	6	A150	3,71
4007220065907	F 8010 6 A 180	F	80	10	6	A180	3,71
4007220065914	F 8010 6 A 240	F	80	10	6	A240	3,71
4007220048412	F 8010 6 A 320	F	80	10	6	A320	3,71
4007220155622	F 8015 6 A 60	F	80	15	6	A60	4,00



LAMELA DE PERNO ÓXIDO DE ALUMÍNIO

10un

SAP	REF	Mod	*	**	Perno	Grão	PREÇO
4007220155639	F 8015 6 A 80	F	80	15	6	A80	4,00
4007220155646	F 8015 6 A 120	F	80	15	6	A120	4,00
4007220155653	F 8015 6 A 150	F	80	15	6	A150	4,00
4007220155684	F 8020 6 A 60	F	80	20	6	A60	4,31
4007220155691	F 8020 6 A 80	F	80	20	6	A80	4,31
4007220155707	F 8020 6 A 120	F	80	20	6	A120	4,31
4007220155714	F 8020 6 A 150	F	80	20	6	A150	4,31
4007220155745	F 8030 6 A 40	F	80	30	6	A40	5,46
4007220155752	F 8030 6 A 60	F	80	30	6	A60	5,46
4007220155769	F 8030 6 A 80	F	80	30	6	A80	5,46
4007220155776	F 8030 6 A 120	F	80	30	6	A120	5,46
4007220155783	F 8030 6 A 150	F	80	30	6	A150	5,46
4007220155790	F 8030 6 A 240	F	80	30	6	A240	5,46
4007220155806	F 8030 6 A 320	F	80	30	6	A320	5,46
4007220155813	F 8040 6 A 60	F	80	40	6	A60	6,79
4007220155820	F 8040 6 A 80	F	80	40	6	A80	6,79
4007220155837	F 8040 6 A 120	F	80	40	6	A120	6,79
4007220155844	F 8040 6 A 150	F	80	40	6	A150	6,79
4007220155851	F 8040 6 A 240	F	80	40	6	A240	6,79
4007220155875	F 8050 6 A 40	F	80	50	6	A40	7,73
4007220155882	F 8050 6 A 60	F	80	50	6	A60	7,73
4007220155899	F 8050 6 A 80	F	80	50	6	A80	7,73
4007220155905	F 8050 6 A 120	F	80	50	6	A120	7,73
4007220155912	F 8050 6 A 150	F	80	50	6	A150	7,73
4007220155929	F 8050 6 A 240	F	80	50	6	A240	7,73
4007220155936	F 8050 6 A 320	F	80	50	6	A320	7,73



LAMELA DE PERNO ÓXIDO DE ALUMÍNIO

2un

SAP	REF	Mod	*	**	Perno	Grão	PREÇO
4007220469040	FR 10030/25,4 A 40	FR	100	30	25,4	A40	15,43
4007220469057	FR 10030/25,4 A 60	FR	100	30	25,4	A60	15,43
4007220469071	FR 10030/25,4 A 80	FR	100	30	25,4	A80	16,27
4007220469095	FR 10030/25,4 A 120	FR	100	30	25,4	A120	16,27
4007220469187	FR 10050/25,4 A 40	FR	100	50	25,4	A40	20,55
4007220469194	FR 10050/25,4 A 60	FR	100	50	25,4	A60	20,55
4007220469224	FR 10050/25,4 A 80	FR	100	50	25,4	A80	20,82
4007220469231	FR 10050/25,4 A 120	FR	100	50	25,4	A120	20,82
4007220296851	FR 15030/25,4 A 40	FR	150	30	25,4	A40	22,20
4007220296868	FR 15030/25,4 A 60	FR	150	30	25,4	A60	22,20
4007220296875	FR 15030/25,4 A 80	FR	150	30	25,4	A80	23,09
4007220296882	FR 15030/25,4 A 120	FR	150	30	25,4	A120	23,09
4007220296899	FR 15030/25,4 A 150	FR	150	30	25,4	A150	25,29
4007220296905	FR 15050/25,4 A 40	FR	150	50	25,4	A40	29,43
4007220296912	FR 15050/25,4 A 60	FR	150	50	25,4	A60	29,43
4007220296929	FR 15050/25,4 A 80	FR	150	50	25,4	A80	34,09
4007220296936	FR 15050/25,4 A 120	FR	150	50	25,4	A120	34,09
4007220296943	FR 15050/25,4 A 150	FR	150	50	25,4	A150	37,50
4007220469699	FR 16530/25,4 A 240	FR	165	30	25,4	A240	41,35
4007220470091	FR 16530/25,4 A 40	FR	165	30	25,4	A40	25,20
4007220470107	FR 16530/25,4 A 60	FR	165	30	25,4	A60	25,20
4007220470114	FR 16530/25,4 A 80	FR	165	30	25,4	A80	25,88
4007220470121	FR 16530/25,4 A 120	FR	165	30	25,4	A120	25,88
4007220470138	FR 16530/25,4 A 150	FR	165	30	25,4	A150	29,75
4007220469941	FR 16530/25,4 A 240	FR	165	30	25,4	A240	31,92
4007220469767	FR 16550/25,4 A 40	FR	165	50	25,4	A40	33,92
4007220469781	FR 16550/25,4 A 60	FR	165	50	25,4	A60	33,92
4007220469804	FR 16550/25,4 A 80	FR	165	50	25,4	A80	36,35
4007220469811	FR 16550/25,4 A 120	FR	165	50	25,4	A120	36,35
4007220469835	FR 16550/25,4 A 150	FR	165	50	25,4	A150	38,70



LAMELA DE PERNO ÓXIDO DE ALUMÍNIO

2un

SAP	REF	Mod	*	**	Perno	Grão	PREÇO
4007220469842	FR 16550/25,4 A 240	FR	165	50	25,4	A240	44,85
4007220469859	FR 16550/25,4 A 320	FR	165	50	25,4	A320	44,85
4007220469606	FR 20030/44,0 A 60	FR	200	30	44	A60	32,85
4007220469613	FR 20030/44,0 A 80	FR	200	30	44	A80	36,14
4007220469637	FR 20030/44,0 A 120	FR	200	30	44	A120	36,14
4007220469675	FR 20030/44,0 A 240	FR	200	30	44	A240	42,99
4007220469262	FR 20050/44,0 A 60	FR	200	50	44	A60	48,85
4007220469286	FR 20050/44,0 A 80	FR	200	50	44	A80	50,73
4007220469309	FR 20050/44,0 A 120	FR	200	50	44	A120	50,73
4007220469323	FR 20050/44,0 A 150	FR	200	50	44	A150	54,75
4007220469347	FR 20050/44,0 A 240	FR	200	50	44	A240	55,32
4007220469064	FR 25050/44,0 A 60	FR	250	50	44	A60	66,57
4007220469088	FR 25050/44,0 A 80	FR	250	50	44	A80	69,36
4007220469101	FR 25050/44,0 A 120	FR	250	50	44	A120	69,36
4007220469132	FR 25050/44,0 A 150	FR	250	50	44	A150	75,23
4007220469156	FR 25050/44,0 A 240	FR	250	50	44	A240	81,84
4007220469170	FR 25050/44,0 A 320	FR	250	50	44	A320	81,84

* Ø Exterior | ** Largura



1

A PFERD fornece lamelas com vários tamanhos de grãos, abrasivos e dimensões. São fornecidas com haste padrão de 40 mm de comprimento, e graças à sua flexibilidade permitem que estas se adaptem perfeitamente aos contornos das peças de trabalho.

2

Para obter um melhor desempenho, é recomendado que use uma velocidade de corte entre 15–20 m/s. Desta forma fornece um compromisso ideal entre a taxa de remoção de material, a qualidade da superfície, a carga térmica na peça de trabalho e o desgaste da ferramenta.

3

Adequadas para trabalhos de acabamento, superfícies de difícil acesso na fabricação de estruturas metálicas e equipamentos, tubos de metais não ferrosos leves e pesados, entre outras.

4

Reduzem a vibração de forma sustentável e os níveis de ruído durante utilizações, melhorando o conforto de trabalho.

4007220807989

JOGO DE LIMAS

5 pcs. 200mm. Com cabo ergonómico.



€ 30.⁷⁵

4007220801017

JOGO DE FRESAS TUNGSTÊNIO

5 pcs. Haste: Ø 6 mm.



€ 62.⁴⁹

4007220133576

JOGO DE FRESAS 1412 ALLROUND

5 pcs. Haste: Ø 6 mm.



€ 137.⁸⁹

4007220232040

RETIFICADORA EGER 8/90

230V. Ø6mm. 2500-900 rpm. 1.8 Kg.



€ 726.⁸⁶

4007220217771

POLIDORA ESER 17/75

230V. Ø19mm. 2700-7500 rpm. 3.1 Kg.



€ 920.⁷⁰

4007220232781

LIXADORA DE CINTA EBER 8/280

230V. Comprimento cinta 520 mm. Largura cinta 3-20mm. 12-32 m/s. 2.1 kg



€ 1057.⁸¹

Discos Abrasivos



01.

02.

03.

04.

corte de aço-inox

uso geral para todo o tipo de materiais

indicado para trabalhos de abrasão exigentes

01. DISCO CORTE METAL PLANO

4007220814376
Ø115-1.2 mm / 13.300 RPM
25un **€ 0.85**

4007220814383
Ø115-1.8 mm / 13.300 RPM
25un **€ 0.96**

4007220814406
Ø125-1.2 mm / 12.200 RPM
25un **€ 0.93**

4007220814659
Ø125-1.8 mm / 12.200 RPM
25un **€ 1.09**

4007220814642
Ø178-1.8 mm / 8.600 RPM
25un **€ 1.52**

4007220814451
Ø230-1.9 mm / 6.600 RPM
25un **€ 2.08**

02. DISCO CORTE METAL CÔNCAVO

4007220814390
Ø115-2.4 mm / 13.300 RPM
25un **€ 0.89**

4007220814420
Ø125-2.4 mm / 12.200 RPM
25un **€ 0.99**

4007220814444
Ø178-2.5 mm / 8.600 RPM
25un **€ 1.56**

4007220814666
Ø230-2.5 mm / 6.600 RPM
25un **€ 1.95**

4007220906880
Ø230-3.2 mm / 6.600 RPM
25un **€ 2.29**

03. DISCO DE REBARBAR

4007220822135
Ø115-6.3 mm / 13.300 RPM
10un **€ 1.75**

4007220822142
Ø125-6.3 mm / 12.200 RPM
10un **€ 1.95**

4007220814475
Ø178-6 mm / 8.600 RPM
10un **€ 3.28**

4007220814482
Ø230-6 mm / 6.600 RPM
10un **€ 4.37**

04. DISCO LAMELADO CÔNCAVO

4007220814499
Ø115-17mm / 3.300 RPM / Z40
10un **€ 2.19**

4007220814505
Ø115-17mm / 13.300 RPM / Z60
10un **€ 2.17**

4007220839560
Ø115-17mm / 13.300 RPM / Z80
10un **€ 2.17**

4007220814543
Ø125-17mm / 12.200 RPM / Z40
10un **€ 2.28**

4007220814550
Ø125-17mm / 12.200 RPM / Z60
10un **€ 2.28**

4007220836576
Ø125-17mm / 12.200 RPM / Z80
10un **€ 2.28**

4007220814598
Ø180-17mm / 8.500 RPM / Z40
10un **€ 5.71**

4007220814604
Ø180-17mm / 8.500 RPM / Z60
10un **€ 5.71**

- ▶ Gama de discos de corte, rebarbar e desbastar fabricada na PFERD-Ruggeberg, marca líder na indústria de abrasivos.
- ▶ A sua linha de produtos foi desenvolvida para uma perfeita aplicação na indústria ou na construção civil.
- ▶ Discos abrasivos da mais alta qualidade, desenvolvidos especificamente para o uso com rebarbadoras. Podem cortar ou desbastar praticamente qualquer material.
- ▶ Uma boa escolha para o uso em aço, aço inox e outros metais.



MADE BY PFERD®



Ferramentas de precisão

FASCINATION  PRECISION®

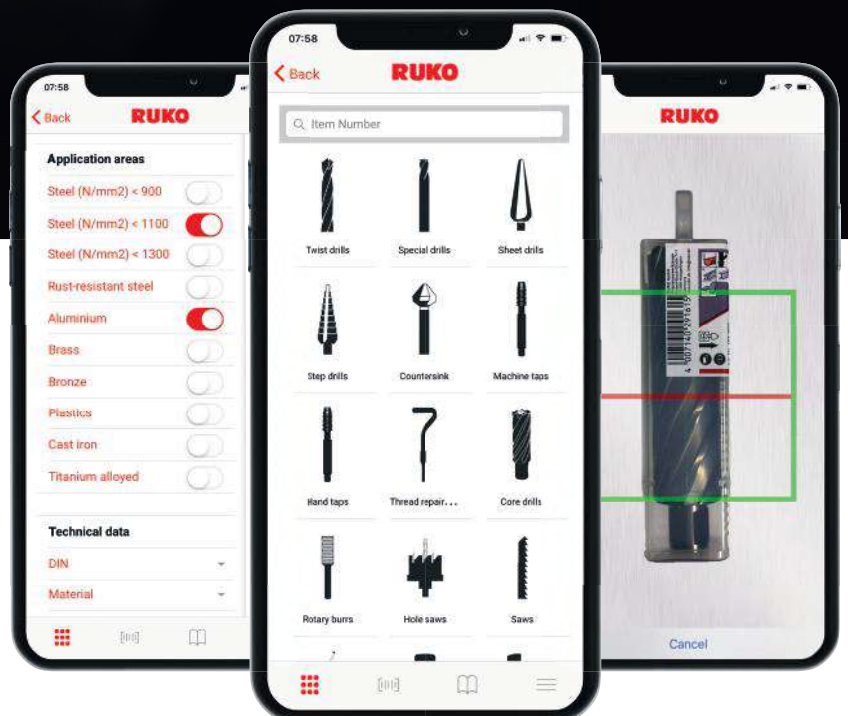



Brocas helicoidais DIN 338 Tipo N, HSS-R

Broca espiral laminada, vaporizada e potente, de aço rápido de alto desempenho. Através do processo de fabricação (sem cortar a estrutura), o material endurece e, assim, torna-se mais elástico. Deste modo, oferece uma maior segurança contra a rutura e é adequada para berbequins resistentes.

Unidade de venda: em embalagens de plástico

<input checked="" type="checkbox"/>	<input checked="" type="checkbox"/>	<input type="checkbox"/>	<input type="checkbox"/>
Aço (N/mm ²) < 900	<input checked="" type="checkbox"/>	Latão	<input type="checkbox"/>
Aço (N/mm ²) < 1100	<input type="checkbox"/>	Bronze	<input checked="" type="checkbox"/>
Aço (N/mm ²) < 1300	<input type="checkbox"/>	Materiais sintéticos	<input type="checkbox"/>
Aço inox	<input type="checkbox"/>	Ferro fundido	<input type="checkbox"/>
Alumínio	<input type="checkbox"/>	Liga de titânio	<input type="checkbox"/>

Aplicação principal Aplicação secundária



HSS-R	Ø mm	L1 mm	L2 mm	Ø	PREÇO
R201003	0,30	19,0	3,0	10	€ 0,37
R201004	0,40	20,0	5,0	10	€ 0,31
R201005	0,50	22,0	6,0	10	€ 0,31
R201006	0,60	24,0	7,0	10	€ 0,31
R201007	0,70	28,0	9,0	10	€ 0,31
R201008	0,80	30,0	10,0	10	€ 0,31
R201009	0,90	32,0	11,0	10	€ 0,31
R201010	1,00	34,0	12,0	10	€ 0,16
R201011	1,10	36,0	14,0	10	€ 0,16
R201012	1,20	38,0	16,0	10	€ 0,16
R2010125	1,25	38,0	16,0	10	€ 0,39
R201013	1,30	38,0	16,0	10	€ 0,16
R201014	1,40	40,0	18,0	10	€ 0,16
R201015	1,50	40,0	18,0	10	€ 0,16
R201016	1,60	43,0	20,0	10	€ 0,16
R201017	1,70	43,0	20,0	10	€ 0,16
R2010175	1,75	46,0	20,0	10	€ 0,39
R201018	1,80	46,0	22,0	10	€ 0,16
R201019	1,90	46,0	22,0	10	€ 0,16
R201020	2,00	49,0	24,0	10	€ 0,16
R201021	2,10	49,0	24,0	10	€ 0,25
R201022	2,20	53,0	27,0	10	€ 0,25
R2010225	2,25	53,0	27,0	10	€ 0,33
R201023	2,30	53,0	27,0	10	€ 0,25
R201024	2,40	57,0	30,0	10	€ 0,25
R201025	2,50	57,0	30,0	10	€ 0,25
R201026	2,60	57,0	30,0	10	€ 0,25
R201027	2,70	61,0	33,0	10	€ 0,25
R2010275	2,75	61,0	33,0	10	€ 0,37
R201028	2,80	61,0	33,0	10	€ 0,25
R201029	2,90	61,0	33,0	10	€ 0,25
R201030	3,00	61,0	33,0	10	€ 0,25
R201031	3,10	65,0	36,0	10	€ 0,29
R201032	3,20	65,0	36,0	10	€ 0,29
R2010325	3,25	65,0	36,0	10	€ 0,47
R201033	3,30	65,0	36,0	10	€ 0,29
R201034	3,40	70,0	39,0	10	€ 0,29
R201035	3,50	70,0	39,0	10	€ 0,29
R201036	3,60	70,0	39,0	10	€ 0,33
R201037	3,70	70,0	39,0	10	€ 0,33

HSS-R	Ø mm	L1 mm	L2 mm	Ø	PREÇO
R2140375	3,75	70,0	39,0	10	€ 0,47
R214038	3,80	75,0	43,0	10	€ 0,33
R214039	3,90	75,0	43,0	10	€ 0,33
R214040	4,00	75,0	43,0	10	€ 0,33
R214041	4,10	75,0	43,0	10	€ 0,33
R214042	4,20	75,0	43,0	10	€ 0,33
R2140425	4,25	75,0	43,0	10	€ 0,56
R214043	4,30	80,0	47,0	10	€ 0,33
R214044	4,40	80,0	47,0	10	€ 0,33
R214045	4,50	80,0	47,0	10	€ 0,33
R214046	4,60	80,0	47,0	10	€ 0,39
R214047	4,70	80,0	47,0	10	€ 0,39
R2140475	4,75	80,0	47,0	10	€ 0,69
R214048	4,80	86,0	52,0	10	€ 0,39
R214049	4,90	86,0	52,0	10	€ 0,39
R214050	5,00	86,0	52,0	10	€ 0,39
R214051	5,10	86,0	52,0	10	€ 0,47
R214052	5,20	86,0	52,0	10	€ 0,47
R2140525	5,25	86,0	52,0	10	€ 0,77
R214053	5,30	86,0	52,0	10	€ 0,47
R214054	5,40	93,0	57,0	10	€ 0,47
R214055	5,50	93,0	57,0	10	€ 0,47
R214056	5,60	93,0	57,0	10	€ 0,47
R214057	5,70	93,0	57,0	10	€ 0,47
R2140575	5,75	93,0	57,0	10	€ 0,84
R214058	5,80	93,0	57,0	10	€ 0,47
R214059	5,90	93,0	57,0	10	€ 0,47
R214060	6,00	93,0	57,0	10	€ 0,47
R214061	6,10	101,0	63,0	10	€ 0,56
R214062	6,20	101,0	63,0	10	€ 0,56
R2140625	6,25	101,0	63,0	10	€ 1,01
R214063	6,30	101,0	63,0	10	€ 0,56
R214064	6,40	101,0	63,0	10	€ 0,56
R214065	6,50	101,0	63,0	10	€ 0,56
R214066	6,60	101,0	63,0	10	€ 0,72
R214067	6,70	101,0	63,0	10	€ 0,72
R2140675	6,75	101,0	63,0	10	€ 1,16
R214068	6,80	109,0	69,0	10	€ 0,72
R214069	6,90	109,0	69,0	10	€ 0,72
R214070	7,00	109,0	69,0	10	€ 0,72

HSS-R	Ø mm	L1 mm	L2 mm	Ø	PREÇO
R201071	0,30	19,0	3,0	10	€ 0,76
R201072	0,40	20,0	5,0	10	€ 0,76
R2010725	0,50	22,0	6,0	10	€ 1,16
R201073	0,60	24,0	7,0	10	€ 0,76
R201074	0,70	28,0	9,0	10	€ 0,76
R201075	0,80	30,0	10,0	10	€ 0,76
R201076	0,90	32,0	11,0	10	€ 0,85
R201077	1,00	34,0	12,0	10	€ 0,85
R2010775	1,10	36,0	14,0	10	€ 1,41
R201078	1,20	38,0	16,0	10	€ 0,85
R201079	1,25	38,0	16,0	10	€ 0,85
R201080	1,30	38,0	16,0	10	€ 0,85
R201081	1,40	40,0	18,0	10	€ 0,91
R201082	1,50	40,0	18,0	10	€ 0,91
R2010825	1,60	43,0	20,0	10	€ 1,41
R201083	1,70	43,0	20,0	10	€ 0,91
R201084	1,75	46,0	20,0	10	€ 0,91
R201085	1,80	46,0	22,0	10	€ 0,91
R201086	1,90	46,0	22,0	10	€ 1,01
R201087	2,00	49,0	24,0	10	€ 1,01
R2010875	2,10	49,0	24,0	10	€ 1,71
R201088	2,20	53,0	27,0	10	€ 1,01
R201089	2,25	53,0	27,0	10	€ 1,01
R201090	2,30	53,0	27,0	10	€ 1,01
R201091	2,40	57,0	30,0	10	€ 1,21
R201092	2,50	57,0	30,0	10	€ 1,21
R2010925	2,60	57,0	30,0	10	€ 1,76
R201093	2,70	61,0	33,0	10	€ 1,21
R201094	2,75	61,0	33,0	10	€ 1,21
R201095	2,80	61,0	33,0	10	€ 1,21
R201096	2,90	61,0	33,0	10	€ 1,33
R201097	3,00	61,0	33,0	10	€ 1,33
R2010975	3,10	65,0	36,0	10	€ 1,99
R201098	3,20	65,0	36,0	10	€ 1,33
R201099	3,25	65,0	36,0	10	€ 1,33
R201100	3,30	65,0	36,0	10	€ 1,33
R201101	3,40	70,0	39,0	10	€ 1,60
R201102	3,50	70,0	39,0	10	€ 1,60
R201103	3,60	70,0	39,0	10	€ 1,60
R201104	3,70	70,0	39,0	10	€ 1,60

HSS-R	Ø mm	L1 mm	L2 mm	Ø	PREÇO
R201105	3,75	70,0	39,0	10	€ 1,60
R201106	3,80	75,0	43,0	10	€ 1,87
R201107	3,90	75,0	43,0	10	€ 1,87
R201108	4,00	75,0	43,0	10	€ 1,87
R201109	4,10	75,0	43,0	10	€ 1,87
R201110	4,20	75,0	43,0	10	€ 1,87
R201111	4,25	75,0	43,0	10	€ 1,91
R201112	4,30	80,0	47,0	10	€ 1,91
R201113	4,40	80,0	47,0	10	€ 1,91
R201114	4,50	80,0	47,0	10	€ 1,91
R201115	4,60	80,0	47,0	10	€ 1,91
R201116	4,70	80,0	47,0	10	€ 2,12
R201117	4,75	80,0	47,0	10	€ 2,12
R201118	4,80	86,0	52,0	10	€ 2,12
R201119	4,90	86,0	52,0	10	€ 2,12
R201120	5,00	86,0	52,0	10	€ 2,12
R201121	5,10	86,0	52,0	10	€ 2,34
R201122	5,20	86,0	52,0	10	€ 2,34
R201123	5,25	86,0	52,0	10	€ 2,34
R201124	5,30	86,0	52,0	10	€ 2,34
R201125	5,40	93,0	57,0	10	€ 2,34
R201126	5,50	93,0	57,0	10	€ 2,44
R201127	5,60	93,0	57,0	10	€ 2,44
R201128	5,70	93,0	57,0	10	€ 2,44
R201129	5,75	93,0	57,0	10	€ 2,44
R201130	5,80	93,0	57,0	10	€ 2,44
R201135	5,90	93,0	57,0	10	€ 2,75
R201140	6,00	93,0	57,0	10	€ 2,75
R201145	6,10	101,0	63,0	10	€ 3,19
R201150	6,20	101,0	63,0	10	€ 3,19
R201155	6,25	101,0	63,0	10	€ 3,96
R201160	6,30	101,0	63,0	10	€ 3,96
R201165	6,40	101,0	63,0	10	€ 4,64
R201170	6,50	101,0	63,0	10	€ 4,99
R201175	6,60	101,0	63,0	10	€ 5,63
R201180	6,70	101,0	63,0	10	€ 5,63
R201185	6,75	101,0	63,0	10	€ 6,10
R201190	6,80	109,0	69,0	10	€ 6,87
R201195	6,90	109,0	69,0	10	€ 7,01
R201200	7,00	109,0	69,0	10	€ 7,58

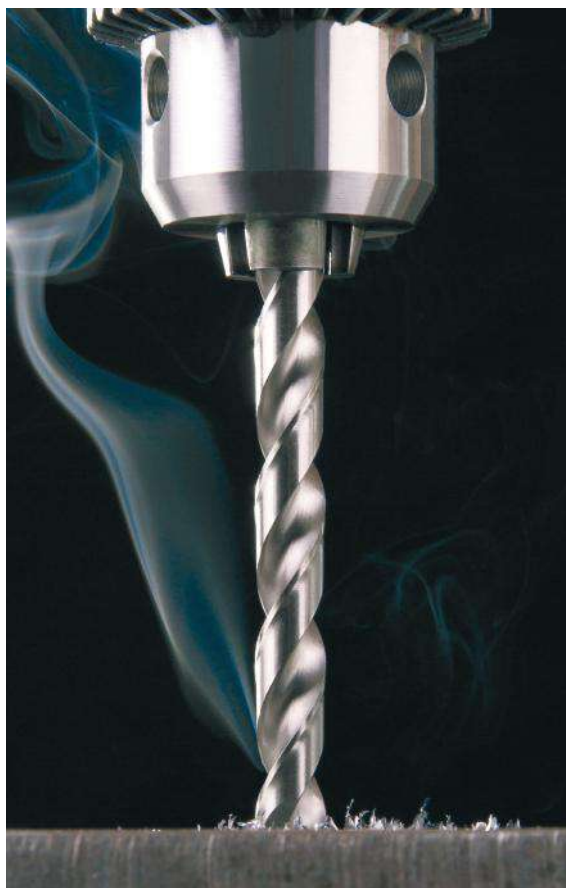



Brocas helicoidais DIN 338 Tipo N, HSS-G

Broca em espiral padrão polida, de elevada potência em aço rápido de alto rendimento. A broca em espiral completamente polida dispõe de uma exactidão de concentricidade precisa. Devido à afiação em cruz esta broca tem uma boa centralização e necessita de uma força de avanço reduzida.



Unidade de venda: em embalagens de plástico

<input checked="" type="checkbox"/>		<input checked="" type="checkbox"/>	
<input checked="" type="checkbox"/>	Aço (N/mm ²) < 900	<input checked="" type="checkbox"/>	Latão
<input type="checkbox"/>	Aço (N/mm ²) < 1100	<input type="checkbox"/>	Bronze
<input type="checkbox"/>	Aço (N/mm ²) < 1300	<input checked="" type="checkbox"/>	Materiais sintéticos
<input type="checkbox"/>	Aço inox	<input type="checkbox"/>	Ferro fundido
<input checked="" type="checkbox"/>	Alumínio	<input type="checkbox"/>	Liga de titânio

Aplicação principal Aplicação secundária

HSS-G	Ø mm	L1 mm	L2 mm	Ø	PREÇO
R214003	0,30	19,0	3,0	10	€ 0,80
R214004	0,40	20,0	5,0	10	€ 0,80
R214005	0,50	22,0	6,0	10	€ 0,80
R214006	0,60	24,0	7,0	10	€ 0,80
R214007	0,70	28,0	9,0	10	€ 0,80
R214008	0,80	30,0	10,0	10	€ 0,80
R214009	0,90	32,0	11,0	10	€ 0,80
R214010	1,00	34,0	12,0	10	€ 0,51
R214011	1,10	36,0	14,0	10	€ 0,51
R214012	1,20	38,0	16,0	10	€ 0,51
R2140125	1,25	38,0	16,0	10	€ 0,51
R214013	1,30	38,0	16,0	10	€ 0,51
R214014	1,40	40,0	18,0	10	€ 0,51
R214015	1,50	40,0	18,0	10	€ 0,51
R214016	1,60	43,0	20,0	10	€ 0,51
R214017	1,70	43,0	20,0	10	€ 0,51
R2140175	1,75	46,0	20,0	10	€ 0,51
R214018	1,80	46,0	22,0	10	€ 0,51
R214019	1,90	46,0	22,0	10	€ 0,51
R214020	2,00	49,0	24,0	10	€ 0,51
R214021	2,10	49,0	24,0	10	€ 0,56
R214022	2,20	53,0	27,0	10	€ 0,56
R2140225	2,25	53,0	27,0	10	€ 0,68
R214023	2,30	53,0	27,0	10	€ 0,56
R214024	2,40	57,0	30,0	10	€ 0,56
R214025	2,50	57,0	30,0	10	€ 0,56
R214026	2,60	57,0	30,0	10	€ 0,56
R214027	2,70	61,0	33,0	10	€ 0,56
R2140275	2,75	61,0	33,0	10	€ 0,68
R214028	2,80	61,0	33,0	10	€ 0,56
R214029	2,90	61,0	33,0	10	€ 0,56
R214030	3,00	61,0	33,0	10	€ 0,56
R214031	3,10	65,0	36,0	10	€ 0,68
R214032	3,20	65,0	36,0	10	€ 0,68
R2140325	3,25	65,0	36,0	10	€ 0,80
R214033	3,30	65,0	36,0	10	€ 0,68
R214034	3,40	70,0	39,0	10	€ 0,68
R214035	3,50	70,0	39,0	10	€ 0,68
R214036	3,60	70,0	39,0	10	€ 0,77
R214037	3,70	70,0	39,0	10	€ 0,77

HSS-G	Ø mm	L1 mm	L2 mm	Ø	PREÇO
R2140375	3,75	70,0	39,0	10	€ 0,95
R214038	3,80	75,0	43,0	10	€ 0,77
R214039	3,90	75,0	43,0	10	€ 0,77
R214040	4,00	75,0	43,0	10	€ 0,77
R214041	4,10	75,0	43,0	10	€ 0,85
R214042	4,20	75,0	43,0	10	€ 0,85
R2140425	4,25	75,0	43,0	10	€ 1,05
R214043	4,30	80,0	47,0	10	€ 0,85
R214044	4,40	80,0	47,0	10	€ 0,85
R214045	4,50	80,0	47,0	10	€ 0,85
R214046	4,60	80,0	47,0	10	€ 1,03
R214047	4,70	80,0	47,0	10	€ 1,03
R2140475	4,75	80,0	47,0	10	€ 1,12
R214048	4,80	86,0	52,0	10	€ 1,03
R214049	4,90	86,0	52,0	10	€ 1,03
R214050	5,00	86,0	52,0	10	€ 1,03
R214051	5,10	86,0	52,0	10	€ 1,21
R214052	5,20	86,0	52,0	10	€ 1,21
R2140525	5,25	86,0	52,0	10	€ 1,23
R214053	5,30	86,0	52,0	10	€ 1,21
R214054	5,40	93,0	57,0	10	€ 1,21
R214055	5,50	93,0	57,0	10	€ 1,21
R214056	5,60	93,0	57,0	10	€ 1,27
R214057	5,70	93,0	57,0	10	€ 1,27
R2140575	5,75	93,0	57,0	10	€ 1,52
R214058	5,80	93,0	57,0	10	€ 1,27
R214059	5,90	93,0	57,0	10	€ 1,27
R214060	6,00	93,0	57,0	10	€ 1,27
R214061	6,10	101,0	63,0	10	€ 1,63
R214062	6,20	101,0	63,0	10	€ 1,63
R2140625	6,25	101,0	63,0	10	€ 1,88
R214063	6,30	101,0	63,0	10	€ 1,63
R214064	6,40	101,0	63,0	10	€ 1,63
R214065	6,50	101,0	63,0	10	€ 1,63
R214066	6,60	101,0	63,0	10	€ 1,91
R214067	6,70	101,0	63,0	10	€ 1,91
R2140675	6,75	101,0	63,0	10	€ 2,59
R214068	6,80	109,0	69,0	10	€ 1,91
R214069	6,90	109,0	69,0	10	€ 1,91
R214070	7,00	109,0	69,0	10	€ 1,91

HSS-G	Ø mm	L1 mm	L2 mm	Ø	PREÇO
R214071	7,10	109,0	69,0	10	€ 1,99
R214072	7,20	109,0	69,0	10	€ 1,99
R2140725	7,25	109,0	69,0	10	€ 2,74
R214073	7,30	109,0	69,0	10	€ 1,99
R214074	7,40	109,0	69,0	10	€ 1,99
R214075	7,50	109,0	69,0	10	€ 1,99
R214076	7,60	117,0	75,0	10	€ 2,32
R214077	7,70	117,0	75,0	10	€ 2,32
R2140775	7,75	117,0	75,0	10	€ 2,91
R214078	7,80	117,0	75,0	10	€ 2,32
R214079	7,90	117,0	75,0	10	€ 2,32
R214080	8,00	117,0	75,0	10	€ 2,32
R214081	8,10	117,0	75,0	10	€ 2,52
R214082	8,20	117,0	75,0	10	€ 2,52
R2140825	8,25	117,0	75,0	10	€ 3,15
R214083	8,30	117,0	75,0	10	€ 2,55
R214084	8,40	117,0	75,0	10	€ 2,55
R214085	8,50	117,0	75,0	10	€ 2,55
R214086	8,60	125,0	81,0	10	€ 2,98
R214087	8,70	125,0	81,0	10	€ 2,98
R2140875	8,75	125,0	81,0	10	€ 4,74
R214088	8,80	125,0	81,0	10	€ 2,98
R214089	8,90	125,0	81,0	10	€ 2,98
R214090	9,00	125,0	81,0	10	€ 2,98
R214091	9,10	125,0	81,0	10	€ 3,27
R214092	9,20	125,0	81,0	10	€ 3,27
R2140925	9,25	125,0	81,0	10	€ 4,80
R214093	9,30	125,0	81,0	10	€ 3,27
R214094	9,40	125,0	81,0	10	€ 3,27
R214095	9,50	125,0	81,0	10	€ 3,27
R214096	9,60	133,0	87,0	10	€ 3,78
R214097	9,70	133,0	87,0	10	€ 3,78
R2140975	9,75	133,0	87,0	10	€ 5,22
R214098	9,80	133,0	87,0	10	€ 3,78
R214099	9,90	133,0	87,0	10	€ 3,78
R214100	10,00	133,0	87,0	10	€ 4,43
R214101	10,10	133,0	87,0	10	€ 4,43
R214102	10,20	133,0	87,0	10	€ 4,43
R214103	10,30	133,0	87,0	10	€ 4,43
R214104	10,40	133,0	87,0	10	€ 4,43

HSS-G	Ø mm	L1 mm	L2 mm	Ø	PREÇO
R214105	10,50	133,0	87,0	5	€ 4,43
R214106	10,60	133,0	87,0	5	€ 5,23
R214107	10,70	142,0	94,0	5	€ 5,23
R214108	10,80	142,0	94,0	5	€ 5,23
R214109	10,90	142,0	94,0	5	€ 5,23
R214110	11,00	142,0	94,0	5	€ 5,23
R214111	11,10	142,0	94,0	5	€ 5,54
R214112	11,20	142,0	94,0	5	€ 5,54
R214113	11,30	142,0	94,0	5	€ 5,54
R214114	11,40	142,0	94,0	5	€ 5,54
R214115	11,50	142,0	94,0	5	€ 5,54
R214116	11,60	142,0	94,0	5	€ 6,05
R214117	11,70	142,0	94,0	5	€ 6,05
R214118	11,80	142,0	94,0	5	€ 6,05
R214119	11,90	151,0	101,0	5	€ 6,05
R214120	12,00	151,0	101,0	5	€ 6,05
R214121	12,10	151,0	101,0	5	€ 6,55
R214122	12,20	151,0	101,0	5	€ 6,55
R214123	12,30	151,0	101,0	5	€ 6,55
R214124	12,40	151,0	101,0	5	€ 6,55
R214125	12,50	151,0	101,0	5	€ 6,55
R214126	12,60	151,0	101,0	5	€ 7,30
R214127	12,70	151,0	101,0	5	€ 7,30
R214128	12,80	151,0	101,0	5	€ 7,30
R214129	12,90	151,0	101,0	5	€ 7,30
R214130	13,00	151,0	101,0	5	€ 7,30
R214135	13,50	160,0	108,0	5	€ 10,41
R214140	14,00	160,0	108,0	5	€ 12,53
R214145	14,50	169,0	114,0	5	€ 14,67
R214150	15,00	169,0	114,0	5	€ 15,77
R214155	15,50	178,0	120,0	5	€ 16,18
R214160	16,00	178,0	120,0	5	€ 19,46
R214165	16,50	184,0	125,0	1	€ 22,07
R214170	17,00	184,0	125,0	1	€ 23,64
R214175	17,50	191,0	130,0	1	€ 24,14
R214180	18,00	191,0	130,0	1	€ 25,32
R214185	18,50	198,0	135,0	1	€ 26,22
R214190	19,00	198,0	135,0	1	€ 27,03
R214195	19,50	205,0	140,0	1	€ 27,43
R214201	20,00	205,0	140,0	1	€ 29,12

Jogos de Brocas helicoidais DIN 338 Tipo N, HSS-G

HSS-G		PREÇO
R214214	com 19 brocas helicoidais DIN 338 tipo N Ø 1,0 até 10,0 x 0,5 mm (aumentando) em estojo de metal	€ 37,67
R214215	com 25 brocas helicoidais DIN 338 tipo N Ø 1,0 até 13,0 x 0,5 mm (aumentando) em estojo de metal	€ 70,45
R214218	com 41 brocas helicoidais DIN 338 tipo N Ø 6,0 até 10,0 x 0,1 mm (aumentando) em estojo de metal	€ 172,00
R214217	com 50 brocas helicoidais DIN 338 tipo N Ø 1,0 até 5,9 x 0,1 mm (aumentando) em estojo de metal	€ 80,54
R214214R0	com 19 brocas helicoidais DIN 338 tipo N Ø 1,0 até 10,0 x 0,5 mm (aumentando) em estojo de plástico	€ 37,67
R214215R0	com 25 brocas helicoidais DIN 338 tipo N Ø 1,0 até 13,0 x 0,5 mm (aumentando) em estojo de plástico	€ 70,45
R214225	com 19 brocas helicoidais DIN 338 tipo N - BIT-BOX Ø 1,0 até 10,0 x 0,5 mm (aumentando) em estojo de plástico	€ 34,50
R214200	com 170 Brocas helicoidais DIN 338, tipo N rectificadas Ø 1,0 até 8,0 mm x 0,5 mm (aumentando) 10 peças cada + Ø 8,5 - 10,0 mm x 0,5 mm (aumentando) 5 peças cada	€ 298,22





Brocas helicoidais DIN 338 Tipo VA, HSSE-Co 5

Broca de alto rendimento de corte recto com resistência distinta à dureza e ao calor. Ideal para perfuração de aço resistente à ferrugem, ao ácido e calor com elevada resistência.

Unidade de venda: em embalagens de plástico

Aço (N/mm2) < 900	<input checked="" type="checkbox"/>	Latão	<input checked="" type="checkbox"/>
Aço (N/mm2) < 1100	<input checked="" type="checkbox"/>	Bronze	<input type="checkbox"/>
Aço (N/mm2) < 1300	<input type="checkbox"/>	Materiais sintéticos	<input checked="" type="checkbox"/>
Aço inox	<input checked="" type="checkbox"/>	Ferro fundido	<input type="checkbox"/>
Alumínio	<input checked="" type="checkbox"/>	Liga de titânio	<input type="checkbox"/>

Aplicação principal Aplicação secundária



	Ø mm	L1 mm	L2 mm	Ø	PREÇO
R215010	1,00	34,0	12,0	10	€ 1,27
R215011	1,10	36,0	14,0	10	€ 1,27
R215012	1,20	38,0	16,0	10	€ 1,27
R2150125	1,25	38,0	16,0	10	€ 1,27
R215013	1,30	38,0	16,0	10	€ 1,27
R215014	1,40	40,0	18,0	10	€ 1,27
R215015	1,50	40,0	18,0	10	€ 1,21
R215016	1,60	43,0	20,0	10	€ 1,27
R215017	1,70	43,0	20,0	10	€ 1,27
R2150175	1,75	46,0	22,0	10	€ 1,27
R215018	1,80	46,0	22,0	10	€ 1,27
R215019	1,90	46,0	22,0	10	€ 1,27
R215020	2,00	49,0	24,0	10	€ 1,01
R215021	2,10	49,0	24,0	10	€ 1,03
R215022	2,20	53,0	27,0	10	€ 1,03
R2150225	2,25	53,0	27,0	10	€ 1,01
R215023	2,30	53,0	27,0	10	€ 1,03
R215024	2,40	57,0	30,0	10	€ 1,11
R215025	2,50	57,0	30,0	10	€ 1,05
R215026	2,60	57,0	30,0	10	€ 1,11
R215027	2,70	61,0	33,0	10	€ 1,15
R2150275	2,75	61,0	33,0	10	€ 1,15
R215028	2,80	61,0	33,0	10	€ 1,15
R215029	2,90	61,0	33,0	10	€ 1,16
R215030	3,00	61,0	33,0	10	€ 1,11
R215031	3,10	65,0	36,0	10	€ 1,16
R215032	3,20	65,0	36,0	10	€ 1,16
R2150325	3,25	65,0	36,0	10	€ 1,21
R215033	3,30	65,0	36,0	10	€ 1,21
R215034	3,40	70,0	39,0	10	€ 1,36
R215035	3,50	70,0	39,0	10	€ 1,36
R215036	3,60	70,0	39,0	10	€ 1,36
R215037	3,70	70,0	39,0	10	€ 1,36
R2150375	3,75	70,0	39,0	10	€ 1,41
R215038	3,80	75,0	43,0	10	€ 1,44
R215039	3,90	75,0	43,0	10	€ 1,45
R215040	4,00	75,0	43,0	10	€ 1,41
R215041	4,10	75,0	43,0	10	€ 1,45
R215042	4,20	75,0	43,0	10	€ 1,45
R2150425	4,25	75,0	43,0	10	€ 1,60

	Ø mm	L1 mm	L2 mm	Ø	PREÇO
R215043	4,30	80,0	47,0	10	€ 1,64
R215044	4,40	80,0	47,0	10	€ 1,64
R215045	4,50	80,0	47,0	10	€ 1,60
R215046	4,60	80,0	47,0	10	€ 1,64
R215047	4,70	80,0	47,0	10	€ 1,64
R2150475	4,75	80,0	47,0	10	€ 1,63
R215048	4,80	86,0	52,0	10	€ 1,71
R215049	4,90	86,0	52,0	10	€ 1,75
R215050	5,00	86,0	52,0	10	€ 1,63
R215051	5,10	86,0	52,0	10	€ 1,83
R215052	5,20	86,0	52,0	10	€ 1,83
R2150525	5,25	86,0	52,0	10	€ 1,80
R215053	5,30	86,0	52,0	10	€ 1,83
R215054	5,40	93,0	57,0	10	€ 2,30
R215055	5,50	93,0	57,0	10	€ 2,26
R215056	5,60	93,0	57,0	10	€ 2,40
R215057	5,70	93,0	57,0	10	€ 2,40
R2150575	5,75	93,0	57,0	10	€ 2,39
R215058	5,80	93,0	57,0	10	€ 2,40
R215059	5,90	93,0	57,0	10	€ 2,40
R215060	6,00	93,0	57,0	10	€ 2,30
R215061	6,10	101,0	63,0	10	€ 2,64
R215062	6,20	101,0	63,0	10	€ 2,64
R2150625	6,25	101,0	63,0	10	€ 2,64
R215063	6,30	101,0	63,0	10	€ 2,64
R215064	6,40	101,0	63,0	10	€ 2,90
R215065	6,50	101,0	63,0	10	€ 2,64
R215066	6,60	101,0	63,0	10	€ 2,90
R215067	6,70	101,0	63,0	10	€ 2,90
R2150675	6,75	101,0	63,0	10	€ 3,06
R215068	6,80	109,0	69,0	10	€ 3,12
R215069	6,90	109,0	69,0	10	€ 3,12
R215070	7,00	109,0	69,0	10	€ 2,87
R215071	7,10	109,0	69,0	10	€ 3,74
R215072	7,20	109,0	69,0	10	€ 3,74
R2150725	7,25	109,0	69,0	10	€ 3,67
R215073	7,30	109,0	69,0	10	€ 3,74
R215074	7,40	109,0	69,0	10	€ 3,74
R215075	7,50	109,0	69,0	10	€ 3,67
R215076	7,60	117,0	75,0	10	€ 4,31

HSSE Co 5	Ø mm	L1 mm	L2 mm	Ø	PREÇO
R215077	7,70	117,0	75,0	10	€ 4,31
R2150775	7,75	117,0	75,0	10	€ 4,27
R215078	7,80	117,0	75,0	10	€ 4,31
R215079	7,90	117,0	75,0	10	€ 4,31
R215080	8,00	117,0	75,0	10	€ 4,27
R215081	8,10	117,0	75,0	10	€ 4,31
R215082	8,20	117,0	75,0	10	€ 4,31
R2150825	8,25	117,0	75,0	10	€ 4,47
R215083	8,30	117,0	75,0	10	€ 4,50
R215084	8,40	117,0	75,0	10	€ 4,50
R215085	8,50	117,0	75,0	10	€ 4,47
R215086	8,60	125,0	81,0	10	€ 5,30
R215087	8,70	125,0	81,0	10	€ 5,30
R2150875	8,75	125,0	81,0	10	€ 5,49
R215088	8,80	125,0	81,0	10	€ 5,50
R215089	8,90	125,0	81,0	10	€ 5,50
R215090	9,00	125,0	81,0	10	€ 5,11
R215091	9,10	125,0	81,0	10	€ 6,02
R215092	9,20	125,0	81,0	10	€ 6,02
R2150925	9,25	125,0	81,0	10	€ 6,30
R215093	9,30	125,0	81,0	10	€ 6,35
R215094	9,40	125,0	81,0	10	€ 6,35
R215095	9,50	125,0	81,0	10	€ 5,65
R215096	9,60	133,0	87,0	10	€ 6,45
R215097	9,70	133,0	87,0	10	€ 6,45
R2150975	9,75	133,0	87,0	10	€ 6,74
R215098	9,80	133,0	87,0	10	€ 6,75
R215099	9,90	133,0	87,0	10	€ 6,75
R215100	10,00	133,0	87,0	10	€ 5,95
R215101	10,10	133,0	87,0	10	€ 6,87
R215102	10,20	133,0	87,0	10	€ 6,87
R215103	10,30	133,0	87,0	10	€ 6,87
R215104	10,40	133,0	87,0	10	€ 6,87
R215105	10,50	133,0	87,0	5	€ 6,87
R215106	10,60	133,0	87,0	5	€ 8,57
R215107	10,70	142,0	94,0	5	€ 8,57
R215108	10,80	142,0	94,0	5	€ 8,57

HSSE Co 5	Ø mm	L1 mm	L2 mm	Ø	PREÇO
R215109	10,90	142,0	94,0	5	€ 8,57
R215110	11,00	142,0	94,0	5	€ 8,54
R215111	11,10	142,0	94,0	5	€ 8,57
R215112	11,20	142,0	94,0	5	€ 10,06
R215113	11,30	142,0	94,0	5	€ 10,06
R215114	11,40	142,0	94,0	5	€ 10,06
R215115	11,50	142,0	94,0	5	€ 9,96
R215116	11,60	142,0	94,0	5	€ 10,41
R215117	11,70	142,0	94,0	5	€ 10,41
R215118	11,80	142,0	94,0	5	€ 10,41
R215119	11,90	151,0	101,0	5	€ 10,41
R215120	12,00	151,0	101,0	5	€ 10,37
R215121	12,10	151,0	101,0	5	€ 12,92
R215122	12,20	151,0	101,0	5	€ 12,92
R215123	12,30	151,0	101,0	5	€ 12,92
R215124	12,40	151,0	101,0	5	€ 12,92
R215125	12,50	151,0	101,0	5	€ 12,80
R215126	12,60	151,0	101,0	5	€ 14,25
R215127	12,70	151,0	101,0	5	€ 14,25
R215128	12,80	151,0	101,0	5	€ 14,25
R215129	12,90	151,0	101,0	5	€ 14,25
R215130	13,00	151,0	101,0	5	€ 14,25
R215135	13,50	160,0	108,0	5	€ 14,08
R215140	14,00	160,0	108,0	5	€ 15,19
R215145	14,50	169,0	114,0	5	€ 18,76
R215150	15,00	169,0	114,0	5	€ 22,43
R215155	15,50	178,0	120,0	5	€ 25,54
R215160	16,00	178,0	120,0	5	€ 29,20
R215165	16,50	184,0	125,0	1	€ 29,79
R215170	17,00	184,0	125,0	1	€ 31,72
R215175	17,50	191,0	130,0	1	€ 33,10
R215180	18,00	191,0	130,0	1	€ 34,59
R215185	18,50	198,0	135,0	1	€ 36,63
R215190	19,00	198,0	135,0	1	€ 37,88
R215195	19,50	205,0	140,0	1	€ 39,61
R215210	20,00	205,0	140,0	1	€ 41,67
-	-	-	-	-	-

Jogos de Brocas helicoidais DIN 338 Tipo VA, HSSE-Co 5

HSSE Co 5		PREÇO
R215214	com 19 brocas helicoidais DIN 338 tipo VA Ø 1,0 até 10,0 x 0,5 mm (aumentando) em estojo de metal	€ 81,12
R215215	com 25 brocas helicoidais DIN 338 tipo VA Ø 1,0 até 13,0 x 0,5 mm (aumentando) em estojo de metal	€ 166,30
R215218	com 41 brocas helicoidais DIN 338 tipo VA Ø 6,0 até 10,0 x 0,1 mm (aumentando) em estojo de metal	€ 333,34
R215217	com 50 brocas helicoidais DIN 338 tipo VA Ø 1,0 até 5,9 x 0,1 mm (aumentando) em estojo de metal	€ 136,99
R215214RO	com 19 brocas helicoidais DIN 338 tipo VA Ø 1,0 até 10,0 x 0,5 mm (aumentando) em estojo de plástico	€ 56,47
R215215 RO	com 25 brocas helicoidais DIN 338 tipo VA Ø 1,0 até 13,0 x 0,5 mm (aumentando) em estojo de plástico	€ 115,79
R215200	com 170 Brocas helicoidais DIN 338, tipo VA rectificadas Ø 1,0 até 8,0 mm x 0,5 mm (aumentando) 10 peças cada + Ø 8,5 - 10,0 mm x 0,5 mm (aumentando) 5 peças cada, em estojo de metal	€ 491,20





Brocas helicoidais DIN 345 Tipo N, HSS

A broca escalonada ULTIMATECUT revoluciona o processo de trabalho e estabelece novos padrões no tempo de processamento, com uma economia de tempo de até 75%. A broca escalonada da RUKO consegue isso através de sua revolucionária geometria de aresta de corte, combinando uma ampla variedade de aplicações e ferramentas. Isso significa menos ferramentas necessárias, sem necessidade de trocar de ferramenta e flexibilidade absoluta.

Unidade de venda: em embalagens de plástico

<input checked="" type="checkbox"/>	<input checked="" type="checkbox"/>	<input checked="" type="checkbox"/>	<input checked="" type="checkbox"/>
Aço (N/mm2) < 900	<input checked="" type="checkbox"/>	Latão	<input checked="" type="checkbox"/>
Aço (N/mm2) < 1100	<input type="checkbox"/>	Bronze	<input type="checkbox"/>
Aço (N/mm2) < 1300	<input type="checkbox"/>	Materiais sintéticos	<input checked="" type="checkbox"/>
Aço inox	<input type="checkbox"/>	Ferro fundido	<input type="checkbox"/>
Alumínio	<input checked="" type="checkbox"/>	Liga de titânio	<input type="checkbox"/>

Aplicação principal Aplicação secundária

HSS	Ø mm	L1 mm	L2 mm		Ø	PREÇO
R204100	10,00	168,0	87,0	1	1	€ 8,09
R204105	10,50	168,0	87,0	1	1	€ 8,09
R204110	11,00	175,0	94,0	1	1	€ 8,69
R204115	11,50	175,0	94,0	1	1	€ 8,89
R204120	12,00	182,0	101,0	1	1	€ 9,22
R204125	12,50	182,0	101,0	1	1	€ 9,90
R204130	13,00	182,0	101,0	1	1	€ 10,60
R204135	13,50	189,0	108,0	1	1	€ 12,14
R204140	14,00	189,0	108,0	1	1	€ 12,92
R204145	14,50	212,0	114,0	2	1	€ 14,72
R204150	15,00	212,0	114,0	2	1	€ 14,72
R204155	15,50	218,0	120,0	2	1	€ 15,64
R204160	16,00	218,0	120,0	2	1	€ 15,64
R204165	16,50	223,0	125,0	2	1	€ 16,64
R204170	17,00	223,0	125,0	2	1	€ 16,64
R204175	17,50	228,0	130,0	2	1	€ 17,64
R204180	18,00	228,0	130,0	2	1	€ 17,64
R204185	18,50	233,0	135,0	2	1	€ 18,50
R204190	19,00	233,0	135,0	2	1	€ 18,50
R204195	19,50	238,0	140,0	2	1	€ 20,26
R204200	20,00	238,0	140,0	2	1	€ 20,26
R204205	20,50	243,0	145,0	2	1	€ 23,64
R204210	21,00	243,0	145,0	2	1	€ 23,64
R204215	21,50	248,0	150,0	2	1	€ 25,29
R204220	22,00	248,0	150,0	2	1	€ 25,29
R204225	22,50	253,0	155,0	2	1	€ 27,64
R204230	23,00	253,0	155,0	2	1	€ 27,64
R204235	23,50	276,0	155,0	3	1	€ 31,18
R204240	24,00	281,0	160,0	3	1	€ 32,95
R204245	24,50	281,0	160,0	3	1	€ 34,02
R204250	25,00	281,0	160,0	3	1	€ 34,73
R204255	25,50	286,0	165,0	3	1	€ 37,70
R204260	26,00	286,0	165,0	3	1	€ 38,29
R204265	26,50	286,0	165,0	3	1	€ 38,29
R204270	27,00	291,0	170,0	3	1	€ 40,18
R204275	27,50	291,0	170,0	3	1	€ 40,69
R204280	28,00	291,0	170,0	3	1	€ 40,69
R204285	28,50	296,0	175,0	3	1	€ 43,01
R204290	29,00	296,0	175,0	3	1	€ 43,57
R204295	29,50	296,0	175,0	3	1	€ 47,10
R204300	30,00	296,0	175,0	3	1	€ 47,10
R204305	30,50	301,0	180,0	3	1	€ 50,63
R204310	31,00	301,0	180,0	3	1	€ 53,46
R204315	31,50	301,0	180,0	3	1	€ 53,46
R204320	32,00	334,0	185,0	4	1	€ 64,15
R204325	32,50	334,0	185,0	4	1	€ 64,15

HSS	Ø mm	L1 mm	L2 mm		Ø	PREÇO
R204330	33,00	334,0	185,0	4	1	€ 67,57
R204335	33,50	334,0	185,0	4	1	€ 67,57
R204340	34,00	339,0	190,0	4	1	€ 71,84
R204345	34,50	339,0	190,0	4	1	€ 78,31
R204350	35,00	339,0	190,0	4	1	€ 78,31
R204355	35,50	339,0	190,0	4	1	€ 81,25
R204360	36,00	344,0	195,0	4	1	€ 84,80
R204365	36,50	344,0	195,0	4	1	€ 87,15
R204370	37,00	344,0	195,0	4	1	€ 91,99
R204375	37,50	344,0	195,0	4	1	€ 91,99
R204380	38,00	349,0	200,0	4	1	€ 94,71
R204385	38,50	349,0	200,0	4	1	€ 101,27
R204390	39,00	349,0	200,0	4	1	€ 101,27
R204395	39,50	349,0	200,0	4	1	€ 105,20
R204400	40,00	349,0	200,0	4	1	€ 105,20
R204405	40,50	354,0	205,0	4	1	€ 115,93
R204410	41,00	354,0	205,0	4	1	€ 115,93
R204415	41,50	354,0	205,0	4	1	€ 118,82
R204420	42,00	354,0	205,0	4	1	€ 121,90
R204425	42,50	354,0	205,0	4	1	€ 124,17
R204430	43,00	359,0	210,0	4	1	€ 125,98
R204435	43,50	359,0	210,0	4	1	€ 130,23
R204440	44,00	359,0	210,0	4	1	€ 130,23
R204445	44,50	359,0	210,0	4	1	€ 133,80
R204450	45,00	359,0	210,0	4	1	€ 136,77
R204455	45,50	364,0	215,0	4	1	€ 136,77
R204460	46,00	364,0	215,0	4	1	€ 140,89
R204465	46,50	364,0	215,0	4	1	€ 148,03
R204470	47,00	364,0	215,0	4	1	€ 148,03
R204475	47,50	364,0	215,0	4	1	€ 151,57
R204480	48,00	369,0	220,0	4	1	€ 153,41
R204485	48,50	369,0	220,0	4	1	€ 160,58
R204490	49,00	369,0	220,0	4	1	€ 160,58
R204495	49,50	369,0	220,0	4	1	€ 165,82
R204500	50,00	369,0	220,0	4	1	€ 214,11
R204510	51,00	412,0	225,0	5	1	€ 221,21
R204520	52,00	412,0	225,0	5	1	€ 224,82
R204530	53,00	412,0	225,0	5	1	€ 240,86
R204540	54,00	417,0	230,0	5	1	€ 247,92
R204550	55,00	417,0	230,0	5	1	€ 247,92
R204560	56,00	417,0	230,0	5	1	€ 260,37
R204570	57,00	422,0	235,0	5	1	€ 273,00
R204580	58,00	422,0	235,0	5	1	€ 273,00
R204590	59,00	422,0	235,0	5	1	€ 280,10
R204600	60,00	422,0	235,0	5	1	€ 280,10
-	-	-	-	-	-	-



Brocas helicoidais rebaixasadas DIN 338 Tipo N

Ideal para perfurar diâmetros maiores para berbequins correntes com mandril até 13,0 mm.

Unidade de venda: em embalagens de plástico

Aço (N/mm ²) < 900	<input checked="" type="checkbox"/>	<input checked="" type="checkbox"/>	<input checked="" type="checkbox"/>
Aço (N/mm ²) < 1100	<input type="checkbox"/>	<input type="checkbox"/>	<input checked="" type="checkbox"/>
Aço (N/mm ²) < 1300	<input type="checkbox"/>	<input type="checkbox"/>	<input type="checkbox"/>
Aço inox	<input type="checkbox"/>	<input checked="" type="checkbox"/>	<input checked="" type="checkbox"/>
Alumínio	<input checked="" type="checkbox"/>	<input checked="" type="checkbox"/>	<input checked="" type="checkbox"/>

Aplicação principal Aplicação secundária

Latão	<input type="checkbox"/>	<input checked="" type="checkbox"/>	<input checked="" type="checkbox"/>
Bronze	<input checked="" type="checkbox"/>	<input type="checkbox"/>	<input type="checkbox"/>
Materiais sintéticos	<input type="checkbox"/>	<input checked="" type="checkbox"/>	<input checked="" type="checkbox"/>
Ferro fundido	<input checked="" type="checkbox"/>	<input checked="" type="checkbox"/>	<input type="checkbox"/>
Liga de titânio	<input type="checkbox"/>	<input type="checkbox"/>	<input type="checkbox"/>



	Ø1 mm	L1 mm	Ø2 mm	L2 mm	🌀	PREÇO
R200105	10,50	133,0	10,0	30,0	1	€ 5,61
R200110	11,00	142,0	10,0	30,0	1	€ 5,91
R200115	11,50	142,0	10,0	30,0	1	€ 5,95
R200120	12,00	151,0	10,0	30,0	1	€ 6,65
R200125	12,50	151,0	10,0	30,0	1	€ 6,65
R200130	13,00	151,0	10,0	30,0	1	€ 6,65
R200135	13,50	160,0	10,0	30,0	1	€ 8,42
R200140	14,00	160,0	10,0	30,0	1	€ 8,62
R200145	14,50	169,0	10,0	30,0	1	€ 9,20
R200150	15,00	169,0	10,0	30,0	1	€ 10,94
R200155	15,50	178,0	10,0	30,0	1	€ 11,05
R200160	16,00	178,0	10,0	30,0	1	€ 11,81
R200165	16,50	184,0	13,0	35,0	1	€ 11,81
R200170	17,00	184,0	13,0	35,0	1	€ 11,81
R200175	17,50	191,0	13,0	35,0	1	€ 14,12
R200180	18,00	191,0	13,0	35,0	1	€ 14,12
R200185	18,50	198,0	13,0	35,0	1	€ 14,37
R200190	19,00	198,0	13,0	35,0	1	€ 14,37
R200195	19,50	205,0	13,0	35,0	1	€ 15,67
R200200	20,00	205,0	13,0	35,0	1	€ 17,04
R200220	22,00	205,0	13,0	35,0	1	€ 24,60
R200240	24,00	205,0	13,0	35,0	1	€ 31,23
R200250	25,00	205,0	13,0	35,0	1	€ 33,43

	Ø1 mm	L1 mm	Ø2 mm	L2 mm	🌀	PREÇO
R2004105	10,50	133,0	10,0	30,0	1	€ 10,57
R2004110	11,00	142,0	10,0	30,0	1	€ 11,22
R2004115	11,50	142,0	10,0	30,0	1	€ 11,77
R2004120	12,00	151,0	10,0	30,0	1	€ 12,38
R2004125	12,50	151,0	10,0	30,0	1	€ 12,77
R2004130	13,00	151,0	10,0	30,0	1	€ 13,56
R2004135	13,50	160,0	10,0	30,0	1	€ 13,99
R2004140	14,00	160,0	10,0	30,0	1	€ 15,48
R2004145	14,50	169,0	10,0	30,0	1	€ 17,11
R2004150	15,00	169,0	10,0	30,0	1	€ 18,67
R2004155	15,50	178,0	10,0	30,0	1	€ 20,39
R2004160	16,00	178,0	10,0	30,0	1	€ 21,81
R2004165	16,50	184,0	13,0	35,0	1	€ 22,65
R2004170	17,00	184,0	13,0	35,0	1	€ 23,64
R2004175	17,50	191,0	13,0	35,0	1	€ 24,18
R2004180	18,00	191,0	13,0	35,0	1	€ 25,20
R2004185	18,50	198,0	13,0	35,0	1	€ 25,62
R2004190	19,00	198,0	13,0	35,0	1	€ 26,42
R2004195	19,50	205,0	13,0	35,0	1	€ 26,57
R2004200	20,00	205,0	13,0	35,0	1	€ 26,92
-	-	-	-	-	-	-
-	-	-	-	-	-	-
-	-	-	-	-	-	-





Jogos de brocas helicoidais DIN 338 Tipo N rebaixadas

Ideal para a perfuração de grandes diâmetros.
Ø 14,0 | 15,0 | 15,5 | 16,0 | 17,0 | 17,5 | 18,0 | 19,0 | 19,5 | 20,0 mm



		PREÇO
R2004201	Jogo de 10 brocas rebaixadas HSS Ø 14,0 até 20,0 mm (aumentando) em estojo de metal	€ 195,35

KIT de 3 Jogos de brocas helicoidais DIN 338

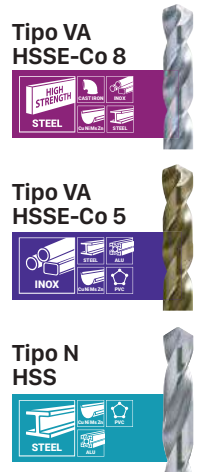
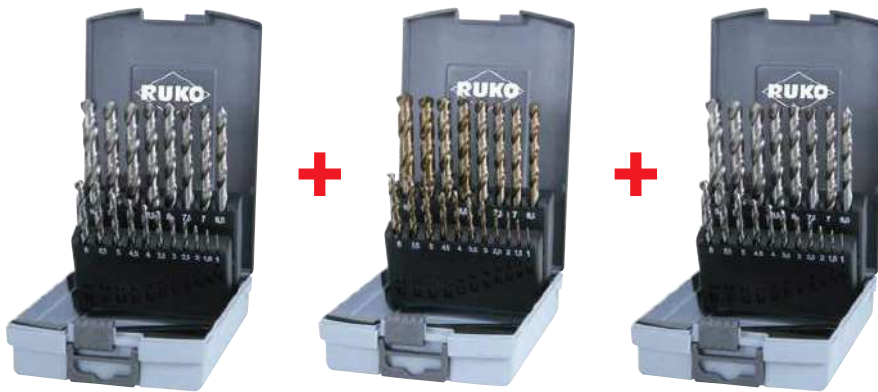

KITRUK01	<i>a broca certa para qualquer aço</i>	PREÇO
R281214ERO R215214RO R214214RO	Jogo de 19 brocas helicoidais DIN 338 Tipo VA HSSE-Co 8 - Ø 1,0 até 10,0 mm x 0,5 mm (aumentando) em estojo de plástico + Jogo de 19 brocas helicoidais DIN 338 Tipo VA HSSE-Co 5 - Ø 1,0 até 10,0 mm x 0,5 mm (aumentando) em estojo de plástico + Jogo de 19 brocas helicoidais DIN 338 Tipo N HSS Ø 1,0 até 10,0 mm x 0,5 mm (aumentando) em estojo de plástico	€ 132,31

KIT de 3 Jogos de brocas +escareadores + fresas



KITRUK02	<i>perfurar, escarear, cortar</i>	PREÇO
R215214RO R102152ERO R245051RO	Jogo de 19 brocas helicoidais DIN 338 Tipo N HSSE-Co 5 - Ø 1,0 até 10,0 mm x 0,5 mm (aumentando) em estojo de plástico + Jogo de 6 brocas helicoidais DIN 335 Tipo C HSSE-Co 5 - Ø 6,3 até 20,5 mm (aumentando) em estojo de plástico + Jogo de 14 Fresas DIN 371/376 Tipo B HSSE-Co 5 M3 até M12 + Ø 2,5 até 10,2 mm (aumentando) em estojo de plástico	€ 220,23

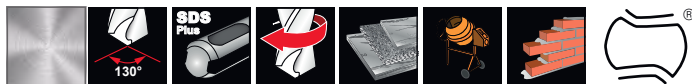

Brocas de percussão SDS-plus

Vida útil superior no betão e sobre armadura graças à geometria da cabeça estabilizada e arestas de corte arredondadas. Design de 2 cortes patenteado segundo o princípio Bionic. Perfil de filamento em espiral Twinmax- 3D inovador possibilita um transporte perfeito do pó de perfuração. Certificado pela „Prüfgemeinschaft Mauerbohrer“ (PGM) conforme os requisitos do Instituto alemão de tecnologia de construção (DiBt, Deutsches Institut für Bautechnik).
Áreas de aplicação: para granito, betão, armaduras para betão, clínquer, pedra, alvenaria e mármore. Pode ser usado em todos os martelos de perfuração com cone SDS-plus e cone de duas ranhuras como p. ex.: Hilti TE 10-22.

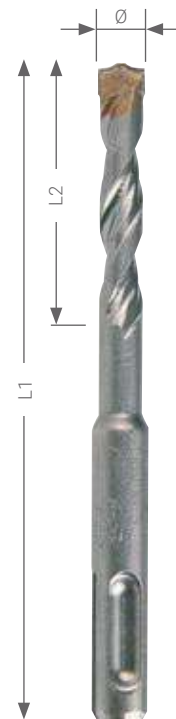

Unidade de venda: com clip SB ou blister de 10 un para referências terminadas em K.
* Com martelos de perfuração mais curtos e com o mesmo diâmetro, perfurar preliminarmente cerca de 150,0 mm.

	Ø mm	L1 mm	L2 mm	ñ	PREÇO
R211035	3,5	110,0	50,0	1	4,51 €
R211040	4,0	110,0	50,0	1	2,91 €
R211041	4,0	160,0	100,0	1	3,96 €
R211050K	5,0	110,0	50,0	10	2,06 €
R211051K	5,0	160,0	100,0	10	2,56 €
R211052	5,0	210,0	150,0	1	3,83 €
R211055	5,5	110,0	50,0	1	2,91 €
R211056	5,5	160,0	100,0	1	3,12 €
R211060K	6,0	110,0	50,0	10	2,06 €
R211061K	6,0	160,0	100,0	10	2,33 €
R211062	6,0	210,0	150,0	1	3,70 €
R211063	6,0	260,0	200,0	1	4,56 €
R211066	6,5	160,0	100,0	1	3,15 €
R211070	7,0	110,0	50,0	1	3,09 €
R211071	7,0	160,0	100,0	1	3,24 €
R211080K	8,0	110,0	50,0	1	2,46 €
R211081K	8,0	160,0	100,0	1	2,64 €
R211082K	8,0	210,0	150,0	1	3,66 €
R211083	8,0	260,0	200,0	1	4,56 €
R211085	8,0	310,0	250,0	1	8,45 €
R211084	8,0	460,0	* 400,0	1	6,25 €
R211086	8,0	610,0	* 550,0	1	13,06 €
R211090	9,0	160,0	100,0	1	3,74 €
R211091	9,0	210,0	150,0	1	4,71 €
R211100K	10,0	160,0	100,0	10	3,13 €
R211101	10,0	210,0	150,0	1	4,78 €
R211102	10,0	260,0	200,0	1	5,28 €
R211104	10,0	310,0	250,0	1	6,17 €
R211105K	10,0	110,0	50,0	10	2,97 €
R211106	10,0	460,0	* 400,0	1	9,24 €
R211107	10,0	610,0	* 550,0	1	13,56 €
R211108	10,0	1000,0	* 950,0	1	32,26 €
R211110	11,0	160,0	100,0	1	4,27 €
R211112	11,0	260,0	200,0	1	5,88 €
R211120K	12,0	160,0	100,0	10	4,10 €
R211121	12,0	260,0	200,0	1	6,47 €
R211122K	12,0	210,0	150,0	1	4,81 €
R211123	12,0	460,0	* 400,0	1	11,12 €

	Ø mm	L1 mm	L2 mm	ñ	PREÇO
R211124	12,0	310,0	250,0	1	€ 7,50
R211125	12,0	600,0	* 550,0	1	€ 14,55
R211126	12,0	1000,0	* 950,0	1	€ 35,45
R211130	13,0	160,0	100,0	1	€ 6,69
R211140K	14,0	160,0	100,0	10	€ 5,26
R211141K	14,0	210,0	150,0	10	€ 6,11
R211142	14,0	260,0	200,0	1	€ 8,05
R211143	14,0	310,0	250,0	1	€ 8,25
R211144	14,0	460,0	* 400,0	1	€ 11,31
R211145	14,0	600,0	* 550,0	1	€ 16,23
R211146	14,0	1000,0	* 950,0	1	€ 38,67
R211150	15,0	160,0	100,0	1	€ 7,16
R211151	15,0	260,0	200,0	1	€ 8,95
R211162	16,0	160,0	100,0	1	€ 14,67
R211161	16,0	450,0	* 400,0	1	€ 8,38
R211165	16,0	600,0	* 550,0	1	€ 17,76
R211167	16,0	1000,0	* 950,0	1	€ 41,94
R211180	18,0	200,0	150,0	1	€ 12,68
R211183	18,0	300,0	250,0	1	€ 18,91
R211181	18,0	450,0	* 400,0	1	€ 45,66
R211185	18,0	600,0	* 550,0	1	€ 14,76
R211182	18,0	1000,0	* 950,0	1	€ 21,87
R211200	20,0	200,0	150,0	1	€ 15,53
R211201	20,0	300,0	250,0	1	€ 17,15
R211202	20,0	450,0	* 400,0	1	€ 21,24
R211203	20,0	600,0	* 550,0	1	€ 24,00
R211204	20,0	1000,0	* 950,0	1	€ 51,61
R211221	22,0	250,0	200,0	1	€ 24,97
R211220	22,0	450,0	* 400,0	1	€ 20,39
R211223	22,0	600,0	* 550,0	1	€ 29,31
R211224	22,0	1000,0	* 950,0	1	€ 58,04
R211240	24,0	250,0	200,0	1	€ 24,61
R211241	24,0	450,0	* 400,0	1	€ 30,90
R211251	25,0	250,0	200,0	1	€ 31,80
R211250	25,0	450,0	* 400,0	1	€ 26,55
R211253	25,0	1000,0	* 950,0	1	€ 71,90
R211260	26,0	450,0	* 400,0	1	€ 35,25
—	—	—	—	—	—

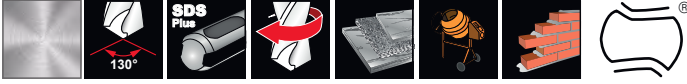

Brocas SDS-plus 4S 4 cortantes

Vida útil superior no betão e sobre armadura graças à geometria da cabeça estabilizada e arestas de corte arredondadas. Design de 4 cortes patenteado segundo o princípio Bionic. Perfil de filamento em espiral Twinmax- 3D inovador possibilita um transporte perfeito do pó de perfuração. Certificado pela „Prüfgemeinschaft Mauerbohrer“ (PGM) conforme os requisitos do Instituto alemão de tecnologia de construção (DIBt, Deutsches Institut für Bautechnik).
Áreas de aplicação: para granito, betão, armaduras para betão, clínquer, pedra, alvenaria e mármore. Pode ser usado em todos os martelos de perfuração com cone SDS-plus e cone de duas ranhuras como p. ex.: Hilti TE 10-22.

Unidade de venda: individual em embalagens de plástico

* Com martelos de perfuração mais curtos e com o mesmo diâmetro, perfurar preliminarmente cerca de 150,0 mm.

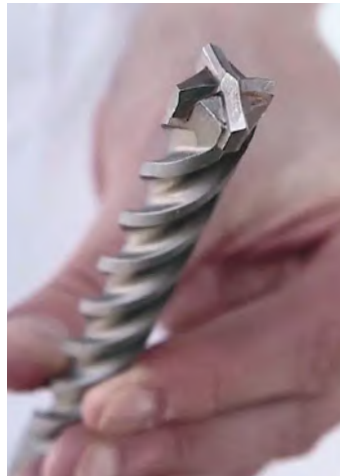

	Ø mm	L1 mm	L2 mm	ñ	PREÇO
R123050	5,0	110,0	50,0	1	€ 4,00
R123051	5,0	160,0	100,0	1	€ 4,39
R123055	5,5	160,0	100,0	1	€ 4,46
R123060	6,0	110,0	50,0	1	€ 4,11
R123061	6,0	160,0	100,0	1	€ 4,53
R123062	6,0	210,0	150,0	1	€ 6,87
R123063	6,0	260,0	200,0	1	€ 8,29
R123065	6,5	210,0	150,0	1	€ 7,09
R123080	8,0	110,0	50,0	1	€ 4,25
R123081	8,0	160,0	100,0	1	€ 4,92
R123082	8,0	210,0	150,0	1	€ 7,51
R123083	8,0	260,0	200,0	1	€ 9,14
R123100	10,0	160,0	100,0	1	€ 5,70
R123101	10,0	210,0	150,0	1	€ 7,94
R123102	10,0	260,0	200,0	1	€ 9,99
R123103	10,0	460,0	400,0	1	€ 25,01
R123120	12,0	160,0	100,0	1	€ 6,77
R123121	12,0	210,0	150,0	1	€ 9,39

	Ø mm	L1 mm	L2 mm	ñ	PREÇO
R123122	12,0	260,0	200,0	1	€ 11,97
R123123	12,0	450,0	400,0	1	€ 28,38
R123140	14,0	160,0	100,0	1	€ 7,79
R123141	14,0	200,0	150,0	1	€ 11,73
R123142	14,0	250,0	200,0	1	€ 14,31
R123143	14,0	450,0	400,0	1	€ 31,57
R123161	16,0	200,0	150,0	1	€ 14,31
R123162	16,0	250,0	200,0	1	€ 17,18
R123163	16,0	300,0	250,0	1	€ 20,62
R123164	16,0	450,0	400,0	1	€ 34,68
R123181	18,0	250,0	200,0	1	€ 18,64
R123182	18,0	450,0	400,0	1	€ 38,12
R123201	20,0	250,0	200,0	1	€ 20,62
R123202	20,0	450,0	400,0	1	€ 41,91
R123221	22,0	450,0	400,0	1	€ 45,63
R123241	24,0	450,0	400,0	1	€ 49,07
R123281	28,0	450,0	400,0	1	€ 59,45
R123301	30,0	450,0	400,0	1	€ 69,37



ULTIMATECUT®

ULTIMATECUT Brocas escalonadas HSS RUnaTEC, ranhuras em espiral com Ponta Turbo

A broca escalonada ULTIMATECUT revoluciona o processo de trabalho e estabelece novos padrões no tempo de processamento, com uma economia de tempo de até 75%. A broca escalonada da RUKO consegue isso através de sua revolucionária geometria de aresta de corte, combinando uma ampla variedade de aplicações e ferramentas. Isso significa menos ferramentas necessárias, sem necessidade de trocar de ferramenta e flexibilidade absoluta.

Unidade de venda: um a um em embalagens de plástico

Aço (N/mm2) < 900	<input checked="" type="checkbox"/>	Latão	<input checked="" type="checkbox"/>
Aço (N/mm2) < 1100	<input checked="" type="checkbox"/>	Bronze	<input type="checkbox"/>
Aço (N/mm2) < 1300	<input type="checkbox"/>	Materiais sintéticos	<input checked="" type="checkbox"/>
Aço inox	<input type="checkbox"/>	Ferro fundido	<input type="checkbox"/>
Alumínio	<input checked="" type="checkbox"/>	Liga de titânio	<input type="checkbox"/>

Aplicação principal Aplicação secundária



HSS	RUnaTEC	Tamanho Nº	Ø1 - Ø2 mm	Área de perfuração Ø mm	L1 mm	Nº escalonamentos	Ø3 mm	📦	PREÇO
		S1	6,0 - 12,00	6,0 / 7,0 / 8,0 / 9,0 / 10,0 / 11,0 / 12,0	105,0	7	8,0	1	€ 72,00
		M2	6,0 - 20,00	6,0 / 8,0 / 10,0 / 12,0 / 14,0 / 16,0 / 18,0 / 20,0	120,0	8	10,0	1	€ 88,43
		L3	6,0 - 27,00	6,0 / 9,0 / 12,0 / 15,0 / 18,0 / 21,0 / 24,0 / 27,0	125,0	8	12,0	1	€ 116,60

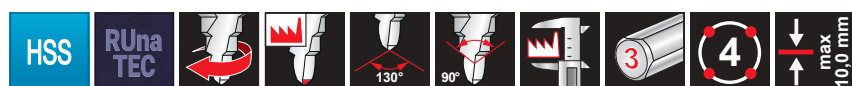

ULTIMATECUT Jogos de Brocas escalonadas HSS RUnaTEC, em caixas de plástico

HSS	RUnaTEC	PREÇO
R101087PRO	ULTIMATECUT Brocas escalonadas tamanhos S1, M2, L3	€ 233,89





Jogos de Brocas escalonadas HSS em mini caixa

HSS	RUna TEC	PREÇO
RA101032	ULTIMATECUT Brocas escalonadas tamanhos S1, M2, L3	€ 76,23



ULTIMATECUT Jogos de escareadores DIN 335 Tipo C 90° HSS em caixas de plástico

HSS	RUna TEC	PREÇO
R102790PRO	ULTIMATECUT Jogo de escareadores (DIN 335) Tipo C 90°, HSS 6 peças Ø 6,3 - 8,3 - 10,4 - 12,4 - 16,5 - 20,5 mm	€ 99,45



Jogos de machos de máquina de abrir roscas M DIN 371 HSS, rectificado em mini caixa

HSS		PREÇO
RA245055	Jogo de macho de máquina de abrir roscas M 4 - M 10	€ 65,74



Jogos de saca bocados com parafuso e vértice de 2 pontos em mala de plástico

	PREÇO	
R109010	3 Saca bocados com parafuso e vértice de 2 pontos 1x 28,3 mm, 1x 32,0 mm, 1x 35,0 mm 1x broca para chapa HSS-TiN N° 2 2x parafuso de fixação MF 12 x 1,5 x 55 qualidade 12.9 1x parafuso de rolamento esferas MF 12 x 1,5 x 60 qualidade 12.9 1x Chave de extremidade 19,0 mm	€ 102,48





Material:
aço especial

Serras Craneanas bimetálicas HSS com dentes variáveis

Unidade de venda: individual em embalagens de cartão

Aço (N/mm ²) < 900	<input checked="" type="checkbox"/>
Aço (N/mm ²) < 1100	<input type="checkbox"/>
Aço (N/mm ²) < 1300	<input type="checkbox"/>
Aço inox	<input type="checkbox"/>
Alumínio	<input checked="" type="checkbox"/>
Latão	<input checked="" type="checkbox"/>
Bronze	<input type="checkbox"/>
Materiais sintéticos	<input checked="" type="checkbox"/>
Ferro fundido	<input type="checkbox"/>
Liga de titânio	<input type="checkbox"/>

Aplicação principal Aplicação secundária

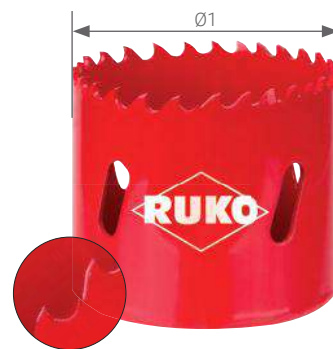

	Ø mm	Ø Zoll	PG	Medidas dos tub. polegadas	Para suporte de assento	↺	PREÇO
R106014	14,0	9/16			A1/A4/A5	1	€ 5,53
R106016	16,0	5/8	~ PG 9		A1/A4/A5	1	€ 7,39
R106017	17,0				A1/A4/A5	1	€ 7,39
R106019	19,0	3/4	~ PG 11	3/8	A1/A4/A5	1	€ 7,39
R106020	20,0				A1/A4/A5	1	€ 7,39
R106021	21,0		~ PG 13,5		A1/A4/A5	1	€ 7,39
R106022	22,0	7/8		1/2	A1/A4/A5	1	€ 7,39
R106024	24,0	15/16	~ PG 16		A1/A4/A5	1	€ 7,39
R106025	25,0	1			A1/A4/A5	1	€ 7,82
R106027	27,0	1 1/16			A1/A4/A5	1	€ 7,82
R106028	28,0	1 3/32			A1/A4/A5	1	€ 7,82
R106029	29,0	1 1/8	~ PG 21	3/4	A1/A4/A5	1	€ 7,82
R106030	30,0	1 3/16			A1/A4/A5	1	€ 7,82
R106032	32,0	1 1/4			A2/A6/A7	1	€ 7,82
R106033	33,0				A2/A6/A7	1	€ 7,82
R106035	35,0	1 3/8		1	A2/A6/A7	1	€ 8,27
R106036	36,0				A2/A6/A7	1	€ 8,27
R106037	37,0		PG 29		A2/A6/A7	1	€ 8,27
R106038	38,0	1 1/2			A2/A6/A7	1	€ 8,27
R106040	40,0				A2/A6/A7	1	€ 8,27
R106041	41,0	1 5/8			A2/A6/A7	1	€ 8,27
R106043	43,0	1 11/16			A2/A6/A7	1	€ 8,27
R106044	44,0	1 3/4		1 1/4	A2/A6/A7	1	€ 9,96
R106046	46,0	1 13/16			A2/A6/A7	1	€ 9,96
R106048	48,0	1 7/8	~ PG 36		A2/A6/A7	1	€ 9,96
R106050	50,0				A2/A6/A7	1	€ 10,04
R106051	51,0	2		1 1/2	A2/A6/A7	1	€ 9,96
R106052	52,0				A2/A6/A7	1	€ 12,16
R106054	54,0	2 1/8	PG 42		A2/A6/A7	1	€ 12,16
R106055	55,0				A2/A6/A7	1	€ 12,24
R106057	57,0	2 1/4			A2/A6/A7	1	€ 12,16
R106059	59,0				A2/A6/A7	1	€ 12,53
R106060	60,0	2 3/8	~ PG 48		A2/A6/A7	1	€ 12,53
R106063	63,0				A2/A6/A7	1	€ 13,36
R106064	64,0	2 1/2		2	A2/A6/A7	1	€ 13,36
R106065	65,0				A2/A6/A7	1	€ 13,36
R106067	67,0	2 5/8			A2/A6/A7	1	€ 13,36
R106068	68,0				A2/A6/A7	1	€ 13,36
R106070	70,0	2 3/4			A2/A6/A7	1	€ 13,36
R106073	73,0	2 7/8			A2/A6/A7	1	€ 13,61
R106076	76,0	3		2 1/2	A2/A6/A7	1	€ 13,92
R106079	79,0	3 1/8			A2/A6/A7	1	€ 14,41
R106083	83,0	3 1/4			A2/A6/A7	1	€ 15,03
R106086	86,0	3 3/8			A2/A6/A7	1	€ 15,75
R106089	89,0	3 1/2			A2/A6/A7	1	€ 16,34
R106092	92,0	3 5/8		3	A2/A6/A7	1	€ 17,08
R106095	95,0	3 3/4			A2/A6/A7	1	€ 19,02
R106098	98,0	3 7/8			A2/A6/A7	1	€ 20,33
R106102	102,0	4			A2/A6/A7	1	€ 21,70
R106105	105,0			3 1/2	A2/A6/A7	1	€ 23,56
R106108	108,0	4 1/4			A2/A6/A7	1	€ 29,04
R106111	111,0	4 3/8			A2/A6/A7	1	€ 34,77
R106114	114,0	4 1/2		4	A2/A6/A7	1	€ 40,94
R106121	121,0	4 3/4			A2/A6/A7	1	€ 45,22
R106127	127,0	5			A2/A6/A7	1	€ 50,45
R106133	133,0				A2/A6/A7	1	€ 55,45
R106140	140,0	5 1/2			A2/A6/A7	1	€ 60,04
R106152	152,0	6			A2/A6/A7	1	€ 70,53
R106160	160,0	6 5/16			A2/A6/A7	1	€ 73,82
R106168	168,0	6 5/8			A2/A6/A7	1	€ 77,24
R106177	177,0				A2/A6/A7	1	€ 78,86
R106200	210,0	8 1/4			A2/A6/A7	1	€ 99,29

**HSSE
Co 8**



**Bi
Metall**



Material:
aço especial

Serras Craneanas bimetálicas HSSE-Co 8 com dentes finos

Unidade de venda: individual em embalagens de cartão

<input type="checkbox"/>	<input type="checkbox"/>	<input type="checkbox"/>	<input type="checkbox"/>
Aço (N/mm2) < 900	<input checked="" type="checkbox"/>	Latão	<input checked="" type="checkbox"/>
Aço (N/mm2) < 1100	<input checked="" type="checkbox"/>	Bronze	<input type="checkbox"/>
Aço (N/mm2) < 1300	<input type="checkbox"/>	Materiais sintéticos	<input checked="" type="checkbox"/>
Aço inox	<input checked="" type="checkbox"/>	Ferro fundido	<input type="checkbox"/>
Alumínio	<input checked="" type="checkbox"/>	Liga de titânio	<input type="checkbox"/>

Aplicação principal Aplicação secundária



	Ø mm	Ø Zoll	PG	Medidas dos tub. polegadas	Para suporte de assento	q	PREÇO
R126014	14,0	9/16			A1/A4/A5	1	€ 6,87
R126016	16,0	5/8	~ PG 9		A1/A4/A5	1	€ 9,16
R126017	17,0				A1/A4/A5	1	€ 9,16
R126019	19,0	3/4	~ PG 11	3/8	A1/A4/A5	1	€ 9,16
R126020	20,0				A1/A4/A5	1	€ 9,16
R126021	21,0		~ PG 13,5		A1/A4/A5	1	€ 9,16
R126022	22,0	7/8		1/2	A1/A4/A5	1	€ 9,16
R126024	24,0	15/16	~ PG 16		A1/A4/A5	1	€ 9,16
R126025	25,0	1			A1/A4/A5	1	€ 9,73
R126027	27,0	1 1/16			A1/A4/A5	1	€ 9,73
R126028	28,0	1 3/32			A1/A4/A5	1	€ 9,73
R126029	29,0	1 1/8	~ PG 21	3/4	A1/A4/A5	1	€ 9,73
R126030	30,0	1 3/16			A1/A4/A5	1	€ 9,73
R126032	32,0	1 1/4			A2/A6/A7	1	€ 9,73
R126033	33,0				A2/A6/A7	1	€ 9,73
R126035	35,0	1 3/8		1	A2/A6/A7	1	€ 10,37
R126036	36,0				A2/A6/A7	1	€ 10,37
R126037	37,0		PG 29		A2/A6/A7	1	€ 10,37
R126038	38,0	1 1/2			A2/A6/A7	1	€ 10,37
R126040	40,0				A2/A6/A7	1	€ 10,37
R126041	41,0	1 5/8			A2/A6/A7	1	€ 10,37
R126043	43,0	1 11/16			A2/A6/A7	1	€ 10,37
R126044	44,0	1 3/4		1 1/4	A2/A6/A7	1	€ 12,42
R126046	46,0	1 13/16			A2/A6/A7	1	€ 12,42
R126048	48,0	1 7/8	~ PG 36		A2/A6/A7	1	€ 12,42
R126050	50,0				A2/A6/A7	1	€ 12,97
R126051	51,0	2		1 1/2	A2/A6/A7	1	€ 12,42
R126052	52,0				A2/A6/A7	1	€ 15,17
R126054	54,0	2 1/8	PG 42		A2/A6/A7	1	€ 15,17
R126055	55,0				A2/A6/A7	1	€ 15,21
R126057	57,0	2 1/4			A2/A6/A7	1	€ 15,17
R126059	59,0				A2/A6/A7	1	€ 15,71
R126060	60,0	2 3/8	~ PG 48		A2/A6/A7	1	€ 15,71
R126063	63,0				A2/A6/A7	1	€ 16,74
R126064	64,0	2 1/2		2	A2/A6/A7	1	€ 16,74
R126065	65,0				A2/A6/A7	1	€ 16,74
R126067	67,0	2 5/8			A2/A6/A7	1	€ 16,74
R126068	68,0				A2/A6/A7	1	€ 16,74
R126070	70,0	2 3/4			A2/A6/A7	1	€ 16,74
R126073	73,0	2 7/8			A2/A6/A7	1	€ 17,78
R126076	76,0	3		2 1/2	A2/A6/A7	1	€ 17,92
R126079	79,0	3 1/8			A2/A6/A7	1	€ 18,52
R126083	83,0	3 1/4			A2/A6/A7	1	€ 19,19
R126086	86,0	3 3/8			A2/A6/A7	1	€ 19,48
R126089	89,0	3 1/2			A2/A6/A7	1	€ 20,98
R126092	92,0	3 5/8		3	A2/A6/A7	1	€ 21,49
R126095	95,0	3 3/4			A2/A6/A7	1	€ 23,81
R126098	98,0	3 7/8			A2/A6/A7	1	€ 25,42
R126102	102,0	4			A2/A6/A7	1	€ 27,09
R126105	105,0			3 1/2	A2/A6/A7	1	€ 29,40
R126108	108,0	4 1/4			A2/A6/A7	1	€ 36,49
R126111	111,0	4 3/8			A2/A6/A7	1	€ 43,43
R126114	114,0	4 1/2		4	A2/A6/A7	1	€ 51,17
R126121	121,0	4 3/4			A2/A6/A7	1	€ 56,52
R126127	127,0	5			A2/A6/A7	1	€ 63,05
R126133	133,0				A2/A6/A7	1	€ 63,05
R126140	140,0	5 1/2			A2/A6/A7	1	€ 75,08
R126152	152,0	6			A2/A6/A7	1	€ 86,37
R126160	160,0	6 5/16			A2/A6/A7	1	€ 91,97
R126168	168,0	6 5/8			A2/A6/A7	1	€ 96,44
R126177	177,0				A2/A6/A7	1	€ 102,03
R126200	210,0	8 1/4			A2/A6/A7	1	€ 119,27

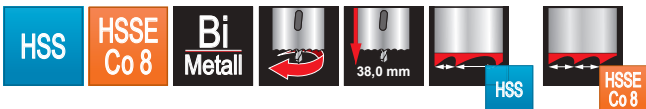

Material:
aço especial

Jogos de serras craneanas bimetálicas HSS e HSSE-Co 8 em caixas de plástico



R106306



R106304



R106318



R126306



R126304



R126318

			PREÇO		PREÇO
PK 1	Para canalizadores 6 serras craneanas bimetálicas Ø 19,0 - 22,0 - 29,0 - 38,0 - 44,0 - 57,0 mm + 2 cone A2 + A4	R106301	€ 90,86	R126301	€ 107,55
PK 2	Para canalizadores 9 serras craneanas bimetálicas Ø 19,0 - 22,0 - 29,0 - 35,0 - 38,0 - 44,0 - 51,0 - 57,0 - 64,0 mm + 2 cone A2 + A4	R106306	€ 125,34	R126306	€ 153,72
EK 1	Para electricistas 6 serras craneanas bimetálicas Ø 22,0 - 29,0 - 35,0 - 44,0 - 51,0 - 64,0 mm + 2 cone A2 + A4	R106305	€ 102,07	R126305	€ 121,59
EK 2	Para electricistas 6 serras craneanas bimetálicas Ø 22,0 - 29,0 - 35,0 - 44,0 - 51,0 - 68,0 mm + 2 cone A2 + A4	R106302	€ 103,14	R126302	€ 122,63
Universal	10 serras craneanas bimetálicas Ø 19,0 - 22,0 - 25,0 - 29,0 - 35,0 - 38,0 - 44,0 - 51,0 - 57,0 - 64,0 mm + 2 cone A2 + A4	R106303	€ 135,43	R126303	€ 169,30
Super	10 serras craneanas bimetálicas Ø 22,0 - 25,0 - 32,0 - 35,0 - 41,0 - 44,0 - 51,0 - 54,0 - 60,0 - 68,0 mm + 2 cone A2 + A4	R106304	€ 139,02	R126304	€ 173,80
Premium	15 serras craneanas bimetálicas Ø 16,0 - 19,0 - 21,0 - 24,0 - 25,0 - 29,0 - 32,0 - 37,0 - 40,0 - 48,0 - 51,0 - 54,0 - 60,0 - 73,0 - 83,0 mm + 2 cone A1 + A2 + 1 Broca de centrar HSS Ø 6,35 mm x 82,0 mm + 1 Extensão 300,0 mm, para cone A1 + A2	R106318	€ 244,41	R126318	€ 252,25

Adaptador para serras craneanas bimetálicas HSS e HSSE-Co 8

Unidade de venda: individual em embalagens de cartão



Serras craneanas bimetálicas Ø mm	Suporte de assento tipo	Haste Ø mm	Haste forma	Rosca	📦	HSS	PREÇO	HSSE Co 5	PREÇO
14,0 - 30,0	A1	A1	○	1/2" x 20	1	R106201	€ 7,66	R126201	€ 12,02
32,0 - 210,0	A2	A2	○	5/8" x 18	1	R106202	€ 11,86	R126202	€ 18,50
14,0 - 30,0	A4	A4	○	1/2" x 20	1	R106204	€ 6,98	R126204	€ 8,73
14,0 - 30,0	A5	A5	○	1/2" x 20	1	R106210	€ 12,12	R126210	€ 15,05
32,0 - 210,0	A6	A6	○	5/8" x 18	1	R106209	€ 11,86	R126209	€ 20,94
32,0 - 210,0	A7	A7	SDS-Plus	5/8" x 18	1	R106211	€ 14,76	R126211	€ 18,50

Acessórios para serras craneanas bimetálicas HSS e HSSE-Co 8

Unidade de venda: individual em embalagens de plástico



	Suporte de assento tipo	📦	HSS	PREÇO	HSSE Co 5	PREÇO
Adaptador para suporte de assento de HSS e serras craneanas HSSE-Co 8 desde Ø 32,0 até Ø 210 mm	A1 / A4 / A5	1	R106212	€ 3,90	-	-
Broca de centrar HSS / HSSE-Co 5, polidos Ø 6,35 x 102,0 mm Polimento em cruz segundo DIN 1412 C	A4	1	R106207	€ 3,63	R126207	€ 4,68
Broca de centrar HSS / HSSE-Co 5, polidos Ø 6,35 x 82,0 mm Polimento em cruz segundo DIN 1412 C	A1 / A2 / A5 A6 / A7	1	R106206	€ 3,63	R126206	€ 4,68
Extensão 300,0 mm, Haste forma ○ 11,0 mm	A1 / A2	1	R106205	€ 15,95	-	-
Mola de ejeção	-	1	R106208	€ 1,09	-	-



Material: aço especial

Jogo de serras craneanas bimetálicas HSS em caixa de plástico

HSS		PREÇO
RA106340	6 serras craneanas bimetálicas Ø 22,0 / 29,0 / 35,0 / 44,0 / 51,0 / 68,0 mm + 2 cone A2 + A4	€ 41,80





Serras craneanas de HSS-G

Unidade de venda: um a um em embalagens de plástico

<input checked="" type="checkbox"/>	<input checked="" type="checkbox"/>	<input type="checkbox"/>	<input type="checkbox"/>
Aço (N/mm ²) < 900	<input checked="" type="checkbox"/>	Latão	<input checked="" type="checkbox"/>
Aço (N/mm ²) < 1100	<input type="checkbox"/>	Bronze	<input type="checkbox"/>
Aço (N/mm ²) < 1300	<input type="checkbox"/>	Materiais sintéticos	<input checked="" type="checkbox"/>
Aço inox	<input type="checkbox"/>	Ferro fundido	<input type="checkbox"/>
Alumínio	<input checked="" type="checkbox"/>	Liga de titânio	<input type="checkbox"/>

Aplicação principal Aplicação secundária



HSS	Ø1 mm	Ø polegadas	Ø2 mm	Ø1 mm	ñ	PREÇO
R128012	12,0	15/32		8,0	1	€ 18,68
R128013	13,0			8,0	1	€ 18,68
R128014	14,0	9/16		8,0	1	€ 19,10
R128015	15,0			10,0	1	€ 19,10
R128016	16,0	5/8		10,0	1	€ 19,10
R128017	17,0			10,0	1	€ 19,10
R128018	18,0			10,0	1	€ 19,10
R128019	19,0	3/4	3/8	10,0	1	€ 19,64
R128020	20,0			10,0	1	€ 20,74
R128021	21,0			10,0	1	€ 21,59
R128022	22,0		1/2	10,0	1	€ 22,70
R128023	23,0			10,0	1	€ 24,57
R128024	24,0	15/16		10,0	1	€ 24,94
R128025	25,0			10,0	1	€ 25,73
R128026	26,0			10,0	1	€ 27,49
R128027	27,0	1 1/16		10,0	1	€ 27,77
R128028	28,0	1 3/32		10,0	1	€ 28,88
R128029	29,0		3/4	10,0	1	€ 30,59
R128030	30,0	1 3/16		10,0	1	€ 31,00
R128031	31,0	1 7/32		10,0	1	€ 32,18
R128032	32,0	1 1/4		10,0	1	€ 33,19
R128033	33,0			10,0	1	€ 34,12
R128034	34,0			10,0	1	€ 35,26

HSS	Ø1 mm	Ø polegadas	Ø2 mm	Ø1 mm	ñ	PREÇO
R128035	35,0	1 3/8	1	10,0	1	€ 36,09
R128036	36,0			10,0	1	€ 37,66
R128037	37,0	1 7/16		10,0	1	€ 38,05
R128038	38,0	1 1/2		10,0	1	€ 39,14
R128039	39,0			10,0	1	€ 42,21
R128040	40,0	1 9/16		10,0	1	€ 42,21
R128041	41,0	1 5/8		10,0	1	€ 42,64
R128042	42,0			10,0	1	€ 43,57
R128043	43,0	1 11/16		10,0	1	€ 44,99
R128044	44,0	1 3/4	1 1/4	10,0	1	€ 45,84
R128045	45,0			10,0	1	€ 48,58
R128046	46,0			10,0	1	€ 48,58
R128047	47,0	1 7/8		10,0	1	€ 48,89
R128048	48,0			10,0	1	€ 51,63
R128049	49,0			10,0	1	€ 52,50
R128050	50,0	1 31/32		10,0	1	€ 52,50
R128055	55,0			12,0	1	€ 70,21
R128060	60,0	2 3/8		12,0	1	€ 76,23
R128065	65,0			12,0	1	€ 97,76
R128070	70,0	2 3/4		12,0	1	€ 110,17
R128075	75,0			12,0	1	€ 110,17
R128080	80,0			12,0	1	€ 135,71
—	—	—	—	—	—	—



Acessórios

Unidade de venda: Individual em embalagens de plástico



HSS		Para serras craneanas MBL Ø mm	Haste	ñ	PREÇO
R128211	Suporte de assento incluindo a broca centrar M 10 x 1,25 mm	12,0 - 14,0	Ø 8,0 mm	1	€ 15,25
R128212	Suporte de assento incluindo a broca centrar M 12 x 1,25 mm	15,0 - 34,0	Ø 10,0 mm	1	€ 15,25
R128213	Suporte de assento incluindo a broca centrar M 14 x 1,50 mm	35,0 - 50,0	Ø 10,0 mm	1	€ 20,66
R128214	Suporte de assento incluindo a broca centrar M 16 x 1,50 mm	51,0 - 100,0	Ø 12,0 mm	1	€ 20,66
R128215	Pino de acerto Ø 6,0 x 52,0 mm	12,0 - 100,0	-	1	€ 6,29
R128216	Mola de ejeção	Ø > 20,0	-	1	€ 1,23

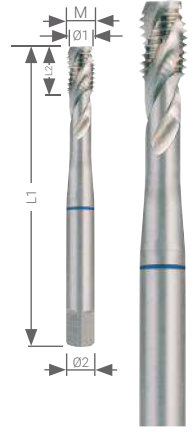

Macho de máquina de abrir roscas M DIN 371 HSS, rectificado

Macho de máquina de abrir roscas com haste reforçada e fresas helicoidais à direita 35° RSP para roscas em furos cegos.

Vértice: molde C / 35° RSP de 2 - 3 fases

Roscas: métricas DIN ISO 13

Flancos: com rectificado posterior

HSS	M	Passo mm	Ø1 mm	L1 mm	L2 mm	Ø2 mm	🌀	PREÇO
R234020	M 2	0,40	1,60	45,0	8,0	2,8	1	€ 11,98
R234025	M 2,5	0,45	2,05	50,0	9,0	2,8	1	€ 9,25
R234030	M 3	0,50	2,50	56,0	11,0	3,5	1	€ 9,25
R234040	M 4	0,70	3,30	63,0	13,0	4,5	1	€ 9,25
R234050	M 5	0,80	4,20	70,0	16,0	6,0	1	€ 9,25
R234060	M 6	1,00	5,00	80,0	19,0	6,0	1	€ 9,65
R234080	M 8	1,25	6,80	90,0	22,0	8,0	1	€ 10,57
R234100	M 10	1,50	8,50	100,0	24,0	10,0	1	€ 12,44



Macho de máquina de abrir roscas M DIN 371 HSS, rectificado

Jogo: de 2 peças

Cortador preliminar: 5 - 6 fases vértice

Cortador final: 2 - 3 fases vértice

Roscas: DIN ISO 228 "G" (rosca para tubagem cilíndrica) / DIN 2999 "Rp" (rosca para tubagem Whitworth)

Flancos: com rectificado posterior

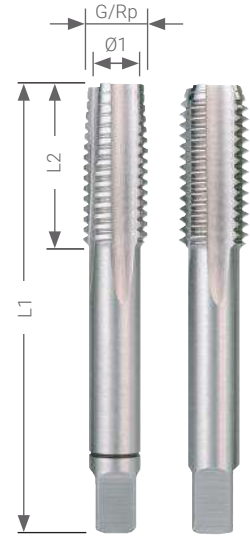

Unidade de venda: jogo em embalagem de plástico

<input checked="" type="checkbox"/>	Aço (N/mm ²) < 900	<input checked="" type="checkbox"/>	Latão
<input checked="" type="checkbox"/>	Aço (N/mm ²) < 1100	<input type="checkbox"/>	Bronze
<input type="checkbox"/>	Aço inox	<input checked="" type="checkbox"/>	Materiais sintéticos
<input type="checkbox"/>	Alumínio	<input type="checkbox"/>	Ferro fundido
<input type="checkbox"/>		<input type="checkbox"/>	Liga de titânio

Aplicação principal Aplicação secundária

Também podem ser vendidas individualmente
Cortador preliminar: Referência N° 236-1
Cortador final: Referência N° 236-2

HSS	Roscas dimensão nominal G / Rp		N° de fios por polegada	Roscas furo central Ø1 mm	L1 mm	L2 mm	🌀	PREÇO
R236018	G 1/8	Rp 1/8	28	8,80	63,0	18,0	1	€ 26,46
R236014	G 1/4	Rp 1/4	19	11,80	70,0	20,0	1	€ 26,04
R236038	G 3/8	Rp 3/8	19	15,25	70,0	20,0	1	€ 30,80
R236012	G 1/2	Rp 1/2	14	19,00	80,0	22,0	1	€ 44,31
R236058	G 5/8	Rp 5/8	14	21,00	80,0	22,0	1	€ 52,84
R236034	G 3/4	Rp 3/4	14	24,50	90,0	22,0	1	€ 66,14
R236078	G 7/8	Rp 7/8	14	28,25	90,0	22,0	1	€ 80,86
R236010	G 1"	Rp 1"	11	30,75	100,0	25,0	1	€ 98,73
R236118	G 1 1/8	Rp 1 1/8	11	35,30	125,0	40,0	1	€ 129,52
R236114	G 1 1/4	Rp 1 1/4	11	39,25	125,0	40,0	1	€ 170,83
R236138	G 1 3/8	Rp 1 3/8	11	41,70	140,0	40,0	1	€ 171,68
R236112	G 1 1/2	Rp 1 1/2	11	45,25	140,0	40,0	1	€ 191,95
R236134	G 1 3/4	Rp 1 3/4	11	51,10	140,0	40,0	1	€ 323,30
R236020	G 2"	Rp 2"	11	57,00	160,0	40,0	1	€ 323,30



Macho de abrir roscas manual M DIN 352 HSS, rectificado

Jogo: de 3 peças
 Cortador preliminar: 6 - 8 fases vértice
 Cortador intermédio: 4 - 5 fases vértice
 Cortador final: 2 - 3 fases vértice
 Roscas: métricas DIN ISO 13
 Flancos: com rectificação posterior

Unidade de venda: jogo em embalagem de plástico

Aço (N/mm ²) < 900	<input checked="" type="checkbox"/>	Latão	<input checked="" type="checkbox"/>
Aço (N/mm ²) < 1100	<input type="checkbox"/>	Bronze	<input type="checkbox"/>
Aço (N/mm ²) < 1300	<input type="checkbox"/>	Materiais sintéticos	<input checked="" type="checkbox"/>
Aço inox	<input type="checkbox"/>	Ferro fundido	<input type="checkbox"/>
Alumínio	<input checked="" type="checkbox"/>	Liga de titânio	<input type="checkbox"/>

Aplicação principal Aplicação secundária

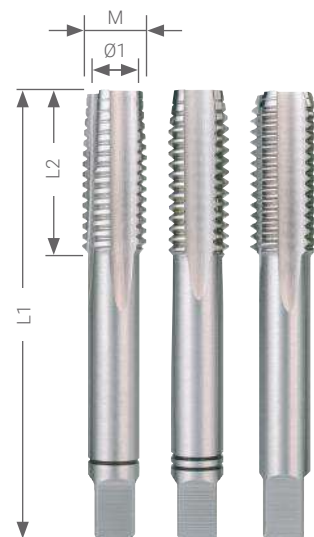

Também podem ser vendidas individualmente
 Cortador preliminar: Referência N° 230-1
 Cortador intermédio: Referência N° 230-2
 Cortador final: Referência N° 230-3

HSS	Roscas dimensão nominal M	Passo mm	Roscas furo central Ø1 mm	L1 mm	L2 mm	Ø	PREÇO
R230020	M 2	0,40	1,60	36,0	8,0	1	€ 11,37
R230025	M 2,5	0,45	2,10	40,0	8,0	1	€ 13,31
R230030	M 3	0,50	2,50	40,0	10,0	1	€ 11,37
R230035	M 3,5	0,60	2,90	45,0	12,0	1	€ 15,32
R230040	M 4	0,70	3,30	45,0	12,0	1	€ 11,37
R230045	M 4,5	0,75	3,70	50,0	16,0	1	€ 14,39
R230050	M 5	0,80	4,20	50,0	13,0	1	€ 11,94
R230060	M 6	1,00	5,00	56,0	15,0	1	€ 12,29
R230070	M 7	1,00	6,00	56,0	16,0	1	€ 12,84
R230080	M 8	1,25	6,80	56,0	18,0	1	€ 13,77
R230090	M 9	1,25	7,80	63,0	22,0	1	€ 20,86
R230100	M 10	1,50	8,50	70,0	24,0	1	€ 17,50
R230110	M 11	1,50	9,50	70,0	24,0	1	€ 26,36
R230120	M 12	1,75	10,20	75,0	29,0	1	€ 22,74
R230140	M 14	2,00	12,00	80,0	30,0	1	€ 28,33
R230150	M 15	2,00	13,00	80,0	32,0	1	€ 34,33
R230160	M 16	2,00	14,00	80,0	32,0	1	€ 34,33
R230180	M 18	2,50	15,50	95,0	40,0	1	€ 49,87
R230200	M 20	2,50	17,50	95,0	40,0	1	€ 53,30
R230220	M 22	2,50	19,50	100,0	40,0	1	€ 69,82
R230240	M 24	3,00	21,00	110,0	45,0	1	€ 79,42
R230270	M 27	3,00	24,00	110,0	50,0	1	€ 101,68
R230300	M 30	3,50	26,50	125,0	56,0	1	€ 129,37
R230330	M 33	3,50	29,50	125,0	56,0	1	€ 155,72
R230360	M 36	4,00	32,00	150,0	63,0	1	€ 182,41
R230390	M 39	4,00	35,00	150,0	63,0	1	€ 234,80
R230420	M 42	4,50	37,50	150,0	63,0	1	€ 262,58
R230450	M 45	4,50	40,50	160,0	70,0	1	€ 302,92
R230480	M 48	5,00	43,00	180,0	75,0	1	€ 432,24
R230520	M 52	5,00	47,00	180,0	75,0	1	€ 456,97

Desandador de machos regulável DIN 1814



Unidade de venda: um a um em embalagens de plástico

	Tamanho	L1 mm	Macho de abrir roscas manual			Ø	PREÇO
			M + MF	Ww	G		
R241112	1 1/2	175,0	1 - M 12	1/8 - 1/2	1/8	1	€ 8,47
R241103	3	370,0	5 - M 20	1/4 - 3/4	1/8 - 1/2	1	€ 16,34



Macho de corte directo G ≈ DIN 5157 HSS, rectificado

Roscas: DIN ISO 228 "G" (rosca para tubagem cilíndrica) / DIN 2999 "Rp" (rosca para tubagem Whitworth)
Flancos: com rectificado posterior

Unidade de venda: jogo em embalagem de plástico

<input checked="" type="checkbox"/>	<input type="checkbox"/>
Aço (N/mm²) < 800	Latão
Aço (N/mm²) < 1100	Bronze
	Materiais sintéticos
Aço inox	Ferro fundido
Alumínio	Liga de titânio

Aplicação principal Aplicação secundária

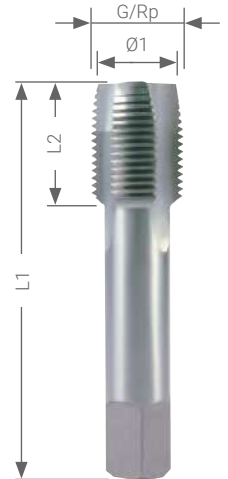

HSS	Roscas dimensão nominal G / Rp		Nº de fios por polegada	Roscas furo central Ø1 mm	L1 mm	L2 mm	🔩	PREÇO
R236218	G 1/8	Rp 1/8	28	8,6	63,0	20,0	1	€ 13,60
R236214	G 1/4	Rp 1/4	19	11,5	70,0	22,0	1	€ 17,76
R236238	G 3/8	Rp 3/8	19	15,0	70,0	22,0	1	€ 21,09
R236212	G 1/2	Rp 1/2	14	19,0	80,0	22,0	1	€ 30,80
R236234	G 3/4	Rp 3/4	14	24,5	90,0	22,0	1	€ 47,26
R236210	G 1"	Rp 1"	11	30,5	100,0	25,0	1	€ 71,73



Jogos de ferramentas de abrir roscas HSS em caixas industriais

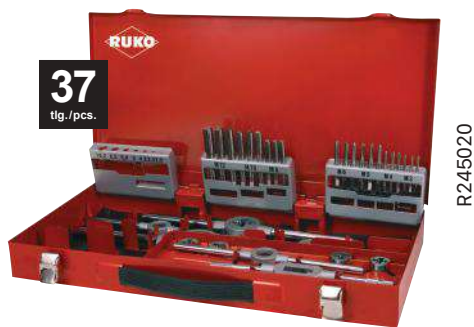

HSS		PREÇO
R245020	Jogo de ferramentas de abrir roscas com 37 peças cada conjunto com 3 peças de machos de abrir roscas manual M DIN 352 M 3 - M 4 - M 5 - M 6 - M 8 - M 10 - M 12 + 7 caçonetes M DIN EN 22568 / M 3 - M 4 - M 5 - M 6 - M 8 - M 10 - M 12 + 5 desandador de caçonete DIN 225 20,0 x 5,0 mm - 20,0 x 7,0 mm - 25,0 x 9,0 mm - 30,0 x 11,0 mm - 38,0 x 14,0 mm + 2 desandador de machos DIN 1814 tamanho 1 / 2 + 1 chave de fendas + 1 contafios	€ 243,76
R245040	Jogo de ferramentas de abrir roscas com 54 peças cada conjunto com 3 peças de machos de abrir roscas manual M DIN 352 M 3 - M 4 - M 5 - M 6 - M 8 - M 10 - M 12 - M 14 - M 16 - M 18 - M 20 + 11 caçonetes M DIN EN 22568 / M 3 - M 4 - M 5 - M 6 - M 8 - M 10 - M 12 - M 14 - M 16 - M 18 - M 20 + 6 desandador de caçonete DIN 225 20,0 x 5,0 mm - 20,0 x 7,0 mm - 25,0 x 9,0 mm - 30,0 x 11,0 mm - 38,0 x 14,0 mm - 45,0 x 18,0 mm + 2 desandador de machos DIN 1814 tamanho 1 + 3 + 1 chave de fendas + 1 contafios	€ 517,65



Macho de corte directo HSS rectificado

Macho de corte directo HSS para roscas de passagem em aços não-ligados e de baixa liga até uma resistência de 800 N/mm², ferro fundido maleável e metais não ferrosos. A rosca pode ser cortada manualmente ou maquinamente numa só fase de operação.

Aço (N/mm ²) < 800	<input checked="" type="checkbox"/>	Latão
Aço (N/mm ²) < 1100	<input type="checkbox"/>	Bronze
	<input type="checkbox"/>	Materiais sintéticos
Aço inox	<input type="checkbox"/>	Ferro fundido
Alumínio	<input checked="" type="checkbox"/>	Liga de titânio

Aplicação principal Aplicação secundária

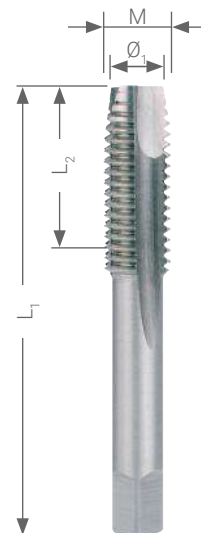

HSS	Para roscas	Roscas furo central Ø1 mm	M mm	L1 mm	L2 mm	Ø	PREÇO
R244603	M 3	3,10	3,6	53,0	13,0	1	€ 5,45
R244604	M 4	4,10	4,9	58,0	16,0	1	€ 5,58
R244605	M 5	5,20	6,0	66,0	19,0	1	€ 5,67
R244606	M 6	6,20	7,3	72,0	22,0	1	€ 6,10
R244608	M 8	8,30	9,6	80,0	24,0	1	€ 6,65
R244610	M 10	10,30	11,9	89,0	29,0	1	€ 9,69
R244612	M 12	12,40	14,3	95,0	30,0	1	€ 11,86
R244614	M 14	14,50	16,6	102,0	32,0	1	€ 13,95
R244615	MF 14	14,50	15,6	102,0	32,0	1	€ 13,95

Gama de reparação de roscas ProCoil em mala de plástico

		PREÇO
R244208	1) Gama M5 - M12 5 broca espiral HSS Ø 5,2 - 6,2 - 8,3 - 10,3 - 12,4 mm + 5 macho de abrir roscas manual DIN 352 HSS M5 - M6 - M8 - M10 - M12 + 5 ferramentas de montagem M5 - M6 - M8 - M10 - M12 + 5 ferramentas de quebra de pino 3,5 - 4,6 - 6,0 - 7,5 - 9,0 mm + 60 insertos roscados M5 - M10, 5 x Ø 1,0 / 1,5 / 2,0 + 6 insertos roscados M12, 2 x Ø 1,0 / 1,5 / 2,0	€ 204,74
R244209	(2) Gama M6 - M14 5 broca espiral HSS Ø 6,2 - 8,3 - 10,3 - 12,4 - 14,5 mm + 5 macho de abrir roscas manual DIN 352 HSS M6 - M8 - M10 - M12 - MF14 + 5 ferramentas de montagem M6 - M8 - M10 - M12 - M14 + 5 ferramentas de quebra de pino Ø 4,6 - 6,0 - 7,5 - 9,0 - 10,0 mm + 45 insertos roscados M6 - M10, 5 x Ø 1,0 / 1,5 / 2,0 + 12 insertos roscados M12 - MF14 2 x Ø 1,0 / 1,5 / 2,0	€ 237,98



Insertos roscados

Versão standard, em aço inoxidável, movimento livre.

Para a blindagem de rosca de materiais com resistência a cisalhamento reduzida, por ex., ligas de alumínio ou magnésio, assim como para a reparação de roscas danificadas ou gastas.

Unidade de venda: em embalagens de plástico



	Roscas dimensão nominal M	Passo mm	Altura = Factor x Ø	📦	PREÇO
R244303	M 3	0,50	1,0	50	€ 0,19
R244304	M 4	0,70	1,0	50	€ 0,19
R244305	M 5	0,80	1,0	50	€ 0,19
R244306	M 6	1,00	1,0	50	€ 0,25
R244308	M 8	1,25	1,0	50	€ 0,25
R244310	M 10	1,50	1,0	50	€ 0,31
R244312	M 12	1,75	1,0	25	€ 0,45
R244314	M 14	2,00	1,0	25	€ 0,72
R244315	MF 14	1,25	1,0	25	€ 0,72
R244403	M 3	0,50	1,5	50	€ 0,19
R244404	M 4	0,70	1,5	50	€ 0,19
R244405	M 5	0,80	1,5	50	€ 0,19
R244406	M 6	1,00	1,5	50	€ 0,25
R244408	M 8	1,25	1,5	50	€ 0,27
R244410	M 10	1,50	1,5	50	€ 0,35
R244412	M 12	1,75	1,5	25	€ 0,56
R244414	M 14	2,00	1,5	25	€ 0,77
R244415	MF 14	1,25	1,5	25	€ 0,77
R244503	M 3	0,50	2,0	50	€ 0,19
R244504	M 4	0,70	2,0	50	€ 0,19
R244505	M 5	0,80	2,0	50	€ 0,25
R244506	M 6	1,00	2,0	50	€ 0,31
R244508	M 8	1,25	2,0	50	€ 0,35
R244510	M 10	1,50	2,0	50	€ 0,41
R244512	M 12	1,75	2,0	25	€ 0,64
R244514	M 14	2,00	2,0	25	€ 0,80
R244515	MF 14	1,25	2,0	25	€ 0,80



Ferramenta de quebra de pino

	M	Ø1 mm	Ø2 mm	Ø3 mm	L1 mm	L2 mm	L3 mm	📦	PREÇO
R244163	M 3	2,0	9,8	6,0	15,0	75,0	25,0	1	€ 4,52
R244164	M 4	2,7	9,8	6,0	20,0	75,0	20,0	1	€ 4,52
R244165	M 5	3,5	9,8	-	22,0	75,0	18,0	1	€ 4,52
R244166	M 6	4,6	9,8	-	22,0	75,0	18,0	1	€ 4,52
R244168	M 8	6,0	9,8	-	40,0	75,0	-	1	€ 5,04
R244170	M 10	7,5	9,8	-	40,0	75,0	-	1	€ 5,04
R244172	M 12	9	12,2	-	40,0	75,0	-	1	€ 6,10
R244174	M 14	10	14,5	-	40,0	75,0	-	1	€ 7,22



Ferramentas de montagem

	M	Ø1 mm	L1 mm	📦	PREÇO
R244183	M 3	2,0	60,0	1	€ 9,77
R244184	M 4	2,8	60,0	1	€ 9,77
R244185	M 5	3,5	60,0	1	€ 9,77
R244186	M 6	4,8	60,0	1	€ 9,77
R244188	M 8	6,0	80,0	1	€ 11,17
R244190	M 10	7,5	80,0	1	€ 12,01
R244192	M 12	9,5	80,0	1	€ 14,04
R244194	M 14	11,2	80,0	1	€ 16,82

Escareador duplo com disco de corte HSS

Suporte de plástico com protecção para as mãos e dois discos de corte HSS.

Discos de corte substituíveis de HSS.

Os discos de corte gastos podem ser rodados nos locais de corte e podem ser assim usados novamente.

A distância dos discos de corte pode ser alterada.

Para rebarba dos dois lados de placas de aço, alumínio, latão, cobre e plástico com uma espessura até 10,0 mm.

Unidade de venda: em embalagens de plástico

		📦	PREÇO
R107060	Escareador duplo completo	1	€ 19,38
R107061	Disco de corte suplente de HSS	2	€ 3,92



Escareador de cantos com lâminas HSS

Suporte de plástico com a parte de trás desparafusável para encaixe de lâminas suplentes.

Lâminas substituíveis.

Indicado para tirar rebarba de cantos, tubos e de placas de aço, alumínio, latão, cobre, fundição de aço e plástico.

Unidade de venda: em embalagens de plástico

		📦	PREÇO
R107050	Escareador de cantos A1 completo com lâmina HSS E 100	1	€ 11,97



Lâmina de serra manual HSS-Co Bihart cobalt

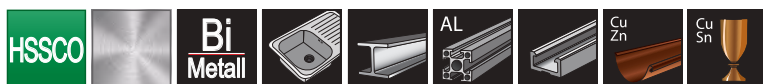

Esta lâmina de serra manual em bimetálico HSS é composta por dois aços diferentes. Os dentes são em aço molibbdénio duro HSS e o corpo da lâmina é de aço ligado, com tratamento térmico. Graças à combinação de ambos os aços numa mesma lâmina, esta torna-se extremamente resistente ao desgaste, inquebrável, adquirindo também um excelente nível de manutenção da capacidade de corte. Adequada para todos os materiais comuns. A lâmina ideal para exigências elevadas.

Disponível: 100 unid. soltas por cada caixa (10 x 10 unid.)

				Passo de dentes - Dentes p/polegadas	Passo de dentes - Dentes p/cm	📦	PREÇO
R312130024R	300,0	13,0	0,65	24 Tpi	10	100	€ 1,15

RUKO Art. No:
3121 300 18 R

HSS-Co Bihart





Fresas de metal duro forma D esfera (KUD)

Unidade de venda: jogo em embalagem de plástico

Aço (N/mm ²) < 900		<input checked="" type="checkbox"/>	<input checked="" type="checkbox"/>	Latão		<input checked="" type="checkbox"/>	<input checked="" type="checkbox"/>
Aço (N/mm ²) < 1100		<input checked="" type="checkbox"/>	<input checked="" type="checkbox"/>	Bronze	<input checked="" type="checkbox"/>		
Aço (N/mm ²) < 1300		<input checked="" type="checkbox"/>	<input checked="" type="checkbox"/>	Materiais sintéticos	<input checked="" type="checkbox"/>		
Aço inox		<input checked="" type="checkbox"/>	<input checked="" type="checkbox"/>	Ferro fundido		<input checked="" type="checkbox"/>	<input checked="" type="checkbox"/>
Alumínio	<input checked="" type="checkbox"/>			Liga de titânio		<input checked="" type="checkbox"/>	<input checked="" type="checkbox"/>

Aplicação principal Aplicação secundária



		Ø1 mm	Ø2 mm	L1 mm	L2 mm	📦	PREÇO
R116041		6,0	6,0	45,0	5,4	1	€ 22,49
R116042		8,0	6,0	47,0	7,2	1	€ 24,26
R116043		10,0	6,0	49,0	9	1	€ 25,94
R116044		12,0	6,0	51,0	11	1	€ 25,80
R116045		16,0	6,0	54,0	14,4	1	€ 38,62



Fresas de metal duro forma C redondo (WRC)

Unidade de venda: jogo em embalagem de plástico

Aço (N/mm ²) < 900		<input checked="" type="checkbox"/>	<input checked="" type="checkbox"/>	Latão		<input checked="" type="checkbox"/>	<input checked="" type="checkbox"/>
Aço (N/mm ²) < 1100		<input checked="" type="checkbox"/>	<input checked="" type="checkbox"/>	Bronze	<input checked="" type="checkbox"/>		
Aço (N/mm ²) < 1300		<input checked="" type="checkbox"/>	<input checked="" type="checkbox"/>	Materiais sintéticos	<input checked="" type="checkbox"/>		
Aço inox		<input checked="" type="checkbox"/>	<input checked="" type="checkbox"/>	Ferro fundido		<input checked="" type="checkbox"/>	<input checked="" type="checkbox"/>
Alumínio	<input checked="" type="checkbox"/>			Liga de titânio		<input checked="" type="checkbox"/>	<input checked="" type="checkbox"/>

Aplicação principal Aplicação secundária

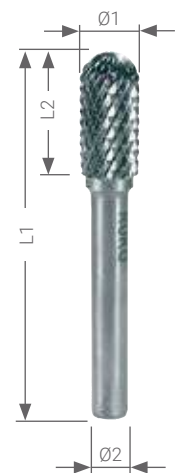

		Ø1 mm	Ø2 mm	L1 mm	L2 mm	📦	PREÇO
R116020		6,0	6,0	56,0	16,0	1	€ 22,70
R116021		8,0	6,0	56,0	16,0	1	€ 22,85
R116022		10,0	6,0	60,0	20,0	1	€ 25,52
R116023		12,0	6,0	65,0	25,0	1	€ 38,04
R116024		16,0	6,0	65,0	25,0	1	€ 46,87



Fresas de metal duro forma G Ojiva (SPG)

Unidade de venda: individual em embalagens de plástico

Aço (N/mm ²) < 900		■	■	Latão		■	■
Aço (N/mm ²) < 1100		■	■	Bronze	■		
Aço (N/mm ²) < 1300		■	■	Materiais sintéticos	■		
Aço inox		■	■	Ferro fundido		■	■
Alumínio	■			Liga de titânio		■	■

■ Aplicação principal □ Aplicação secundária

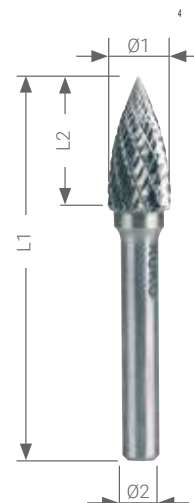

		Ø1 mm	Ø2 mm	L1 mm	L2 mm	🌀	PREÇO
R116025		6,0	6,0	58,0	18,0	1	€ 23,37
R116026		8,0	6,0	60,0	18,0	1	€ 25,01
R116027		10,0	6,0	60,0	20,0	1	€ 24,86
R116028		12,0	6,0	65,0	25,0	1	€ 25,97
R116029		16,0	6,0	70,0	25,0	1	€ 52,88



Fresas de metal duro forma M cone pontiagudo (SKM)

Unidade de venda: individual em embalagens de plástico

Aço (N/mm ²) < 900	■	■	Latão	■	■
Aço (N/mm ²) < 1100	■	■	Bronze		
Aço (N/mm ²) < 1300	■	■	Materiais sintéticos		
Aço inox	■	■	Ferro fundido	■	■
Alumínio			Liga de titânio	■	■

■ Aplicação principal □ Aplicação secundária

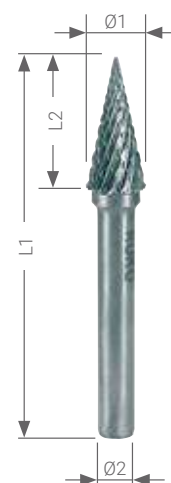

		Ø1 mm	Ø2 mm	L1 mm	L2 mm	🌀	PREÇO
R116035		6,0	6,0	58,0	18,0	1	€ 22,70
R116036		8,0	6,0	60,0	20,0	1	€ 25,62
R116037		10,0	6,0	60,0	20,0	1	€ 28,84
R116038		12,0	6,0	65,0	25,0	1	€ 31,74
R116039		16,0	6,0	65,0	25,0	1	€ 46,56



Fresas de metal duro forma F semicircular (RBF)

Unidade de venda: individual em embalagens de plástico

	ALU	CT4	CF4		ALU	CT4	CF4
Aço (N/mm ²) < 900		■	■	Latão		■	■
Aço (N/mm ²) < 1100		■	■	Bronze	■		
Aço (N/mm ²) < 1300		■	■	Materiais sintéticos	■		
Aço inox		■	■	Ferro fundido		■	■
Alumínio	■			Liga de titânio		■	■

■ Aplicação principal □ Aplicação secundária



TC	CT4	Ø1 mm	Ø2 mm	L1 mm	L2 mm	🔩	PREÇO
R116030		6,0	6,0	58,0	18,0	1	€ 23,37
R116031		8,0	6,0	60,0	18,0	1	€ 24,56
R116032		10,0	6,0	60,0	20,0	1	€ 26,18
R116033		12,0	6,0	65,0	25,0	1	€ 38,70
R116034		16,0	6,0	70,0	30,0	1	€ 45,76



Fresas de metal duro forma B cilíndrica (ZYAS) com frontal

Unidade de venda: individual em embalagens de plástico

	ALU	CT4	CF4		ALU	CT4	CF4
Aço (N/mm ²) < 900		■	■	Latão		■	■
Aço (N/mm ²) < 1100		■	■	Bronze	■		
Aço (N/mm ²) < 1300		■	■	Materiais sintéticos	■		
Aço inox		■	■	Ferro fundido		■	■
Alumínio	■			Liga de titânio		■	■

■ Aplicação principal □ Aplicação secundária

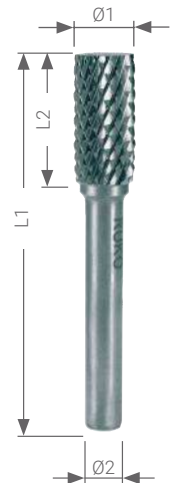

TC	CT4	Ø1 mm	Ø2 mm	L1 mm	L2 mm	🔩	PREÇO
R116015		6,0	6,0	58,0	18,0	1	€ 23,11
R116016		8,0	6,0	60,0	18,0	1	€ 25,48
R116017		10,0	6,0	60,0	20,0	1	€ 27,39
R116018		12,0	6,0	65,0	25,0	1	€ 38,70
R116019		16,0	6,0	65,0	25,0	1	€ 54,33



Fresas de metal duro forma B cilíndrica (ZYAS) sem frontal



Unidade de venda: individual em embalagens de plástico

	ALU	CT4	CT4		ALU	CT4	CT4
Aço (N/mm ²) < 900		■	■	Latão		■	■
Aço (N/mm ²) < 1100		■	■	Bronze	■		
Aço (N/mm ²) < 1300		■	■	Materiais sintéticos	■		
Aço inox		■	■	Ferro fundido		■	■
Alumínio	■			Liga de titânio		■	■

■ Aplicação principal □ Aplicação secundária

TC	CT4	Ø1 mm	Ø2 mm	L1 mm	L2 mm	🔩	PREÇO
R116010		6,0	6,0	58,0	18,0	1	€ 18,30
R116011		8,0	6,0	60,0	18,0	1	€ 22,42
R116012		10,0	6,0	60,0	20,0	1	€ 25,74
R116013		12,0	6,0	65,0	25,0	1	€ 34,94
R116014		16,0	6,0	65,0	25,0	1	€ 44,01



Jogo de Fresas metal duro em expositor



TC	CT4		PREÇO
R116008		Jogo de fresas para metais duros com 35 peças num prático expositor de vendas 1 x Ø D1 6,0 mm + 8,0 mm + 10,0 mm + 12,0 mm + 16,0 mm 5 pinos para fresar forma A, cilíndrica (ZYA) sem passo de dentes de topo + 5 pinos para fresar forma B, cilíndrica (ZYAS) com passo de dentes de topo + 5 pinos para fresar forma C, Redondo (WRC) + 5 pinos para fresar forma G, Ojiva (SPG) + 5 pinos para fresar forma F, Semicircular (RBF) + 5 pinos para fresar forma M, Cone pontiagudo (SKM) + 5 pinos para fresar forma D, Esfera (KUD)	€ 639,38



ULTIMATECUT®

ULTIMATECUT Brocas helicoidais DIN 338 Tipo FLOWSTEP® HSSE-Co 5 + HSS

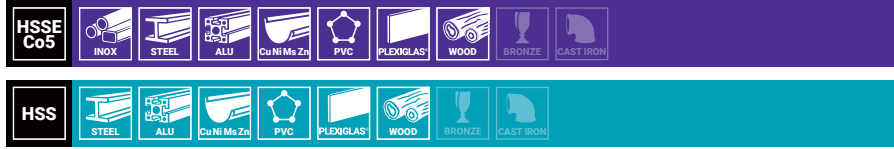

Unidade de venda: em embalagens de plástico

Ponta **FLOWSTEP®**.
Centralização perfeita, não escapa em superfícies redondas como canos e tubos.
Processo de perfuração fácil e suave, sem encravamentos no material.
Perfuração extremamente rápida e economizadora de energia.
Economia de tempo de até 50%.
Vida útil da ferramenta significativamente maior – é possível fazer até 5x mais furos.
Ótimo desempenho berbequins manuais (sem fio).

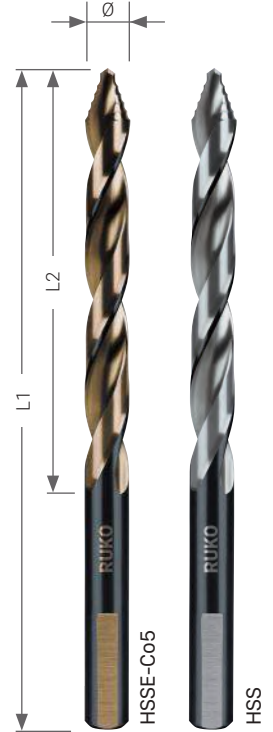

HSSE Co5	Ø mm	L1 mm	L2 mm	✎	PREÇO
R259010E	1.00	34.0	12.0	10	€ 2,86
R259015E	1.50	40.0	18.0	10	€ 3,05
R259020E	2.00	49.0	24.0	10	€ 3,24
R259025E	2.50	57.0	30.0	10	€ 3,40
R259030E	3.00	61.0	33.0	10	€ 3,57
R259033E	3.30	65.0	36.0	10	€ 4,12
R259035E	3.50	70.0	39.0	10	€ 4,22
R259040E	4.00	75.0	43.0	10	€ 4,39
R259042E	4.20	75.0	43.0	10	€ 5,38
R259045E	4.50	80.0	47.0	10	€ 5,55
R259050E	5.00	86.0	52.0	10	€ 5,73
R259055E	5.50	93.0	57.0	5	€ 6,81
R259060E	6.00	93.0	57.0	5	€ 6,97
R259065E	6.50	101.0	63.0	5	€ 7,88
R259068E	6.80	109.0	69.0	5	€ 8,40
R259070E	7.00	109.0	69.0	5	€ 8,40
R259075E	7.50	109.0	69.0	5	€ 8,95
R259080E	8.00	117.0	75.0	5	€ 10,73
R259085E	8.50	117.0	75.0	1	€ 11,09
R259090E	9.00	125.0	81.0	1	€ 13,95
R259095E	9.50	125.0	81.0	1	€ 15,57
R259100E	10.00	133.0	87.0	1	€ 15,73
R259102E	10.20	133.0	87.0	1	€ 19,33
R259105E	10.50	133.0	87.0	1	€ 19,68
R259110E	11.00	142.0	94.0	1	€ 20,59
R259115E	11.50	142.0	94.0	1	€ 21,47
R259120E	12.00	151.0	101.0	1	€ 22,37
R259125E	12.50	151.0	101.0	1	€ 23,25
R259130E	13.00	151.0	101.0	1	€ 24,16

HSS	Ø mm	L1 mm	L2 mm	✎	PREÇO
R259010	1.00	34.0	12.0	10	€ 1,95
R259015	1.50	40.0	18.0	10	€ 2,08
R259020	2.00	49.0	24.0	10	€ 2,21
R259025	2.50	57.0	30.0	10	€ 2,33
R259030	3.00	61.0	33.0	10	€ 2,44
R259033	3.30	65.0	36.0	10	€ 2,81
R259035	3.50	70.0	39.0	10	€ 2,88
R259040	4.00	75.0	43.0	10	€ 2,98
R259042	4.20	75.0	43.0	10	€ 3,68
R259045	4.50	80.0	47.0	10	€ 3,78
R259050	5.00	86.0	52.0	10	€ 3,91
R259055	5.50	93.0	57.0	5	€ 4,64
R259060	6.00	93.0	57.0	5	€ 4,77
R259065	6.50	101.0	63.0	5	€ 5,38
R259068	6.80	109.0	69.0	5	€ 5,73
R259070	7.00	109.0	69.0	5	€ 5,73
R259075	7.50	109.0	69.0	5	€ 6,11
R259080	8.00	117.0	75.0	5	€ 7,33
R259085	8.50	117.0	75.0	1	€ 7,58
R259090	9.00	125.0	81.0	1	€ 9,52
R259095	9.50	125.0	81.0	1	€ 10,63
R259100	10.00	133.0	87.0	1	€ 10,76
R259102	10.20	133.0	87.0	1	€ 13,19
R259105	10.50	133.0	87.0	1	€ 13,44
R259110	11.00	142.0	94.0	1	€ 14,03
R259115	11.50	142.0	94.0	1	€ 14,66
R259120	12.00	151.0	101.0	1	€ 15,27
R259125	12.50	151.0	101.0	1	€ 15,88
R259130	13.00	151.0	101.0	1	€ 16,49

ULTIMATECUT Jogo de brocas helicoidais DIN 338 Tipo FLOWSTEP® HSSE-Co 5

HSSE Co5		PREÇO
R259214ERO	Jogo de 19 brocas ULTIMATECUT DIN 338 tipo FLOWSTEP® HSSE-Co 5 Ø 1,0 - 10,0 x 0.5 mm	€ 118,63
R259215ERO	Jogo de 25 brocas ULTIMATECUT DIN 338 tipo FLOWSTEP® HSSE-Co 5 Ø 1,0 - 13,0 x 0.5 mm	€ 177,94



ULTIMATECUT Jogo de brocas helicoidais DIN 338 Tipo FLOWSTEP® HSS

HSS		PREÇO
R259214RO	Jogo de 19 brocas ULTIMATECUT DIN 338 tipo FLOWSTEP® HSS Ø 1,0 - 10,0 x 0.5 mm	€ 98,86
R259215RO	Jogo de 25 brocas ULTIMATECUT DIN 338 tipo FLOWSTEP® HSS Ø 1,0 - 13,0 x 0.5 mm	€ 144,33



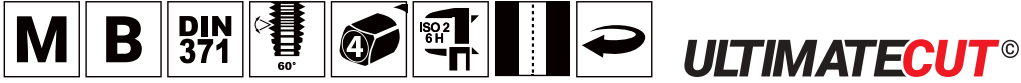

ULTIMATECUT Jogo de Machos DIN 371/376 tipo B e brocas Helicoidais DIN 338 Tipo FLOWSTEP® HSSE-Co 5



HSSE Co5		PREÇO
R259048ERO	Jogo de 14 peças 7 machos máquina DIN 371/376 tipo B com machos progressivo HSSE-Co 5 M 3 - M 4 - M 5 - M 6 - M 8 - M 10 - M 12 + 7 brocas ULTIMATECUT DIN 338 tipo FLOWSTEP® HSSE-Co 5 Ø 2,5 - 3,3 - 4,2 - 5,0 - 6,8 - 8,5 - 10,2 mm	€ 118,56



ULTIMATECUT Jogo de Machos DIN 371/376 tipo B e brocas Helicoidais DIN 338 Tipo FLOWSTEP® HSS



HSS		PREÇO
R259048RO	Jogo de 14 peças 7 machos máquina DIN 371/376 tipo B com machos progressivo HSS M 3 - M 4 - M 5 - M 6 - M 8 - M 10 - M 12 + 7 brocas ULTIMATECUT DIN 338 tipo FLOWSTEP® HSS Ø 2,5 - 3,3 - 4,2 - 5,0 - 6,8 - 8,5 - 10,2 mm	€ 82,16

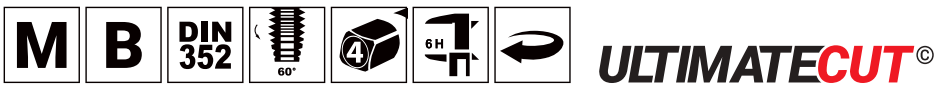

ULTIMATECUT Jogo de Machos DIN 372/376 tipo B e brocas Helicoidais DIN 338 Tipo FLOWSTEP® HSS



HSS		PREÇO
R259004RO	Jogo de 15 peças 7 machos máquina DIN 352 HSS M 3 - M 4 - M 5 - M 6 - M 8 - M 10 - M 12 + 7 brocas ULTIMATECUT DIN 338 tipo FLOWSTEP® HSS Ø 2,5 - 3,3 - 4,2 - 5,0 - 6,8 - 8,5 - 10,2 mm	€ 63,82



Ferramentas de precisão

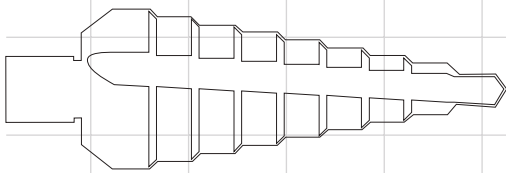
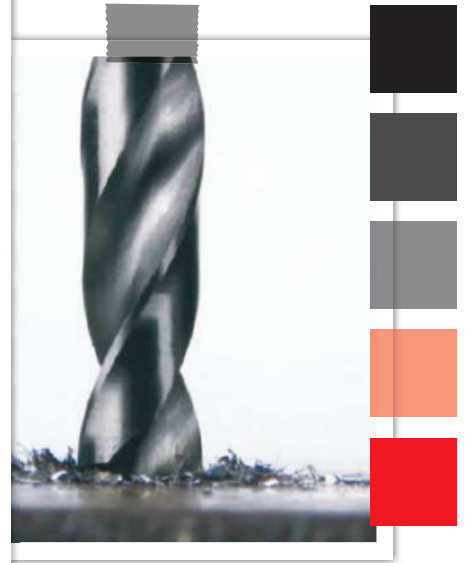
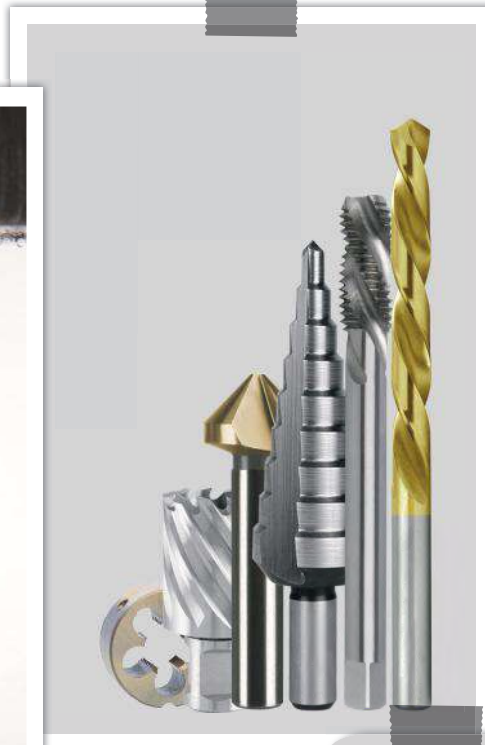

► Fabricado pela Ruko para oferecer um produto mais competitivo de uso geral.



© PARA MAIS INFORMAÇÕES TÉCNICAS CONTACTE O NOSSO SERVIÇO DE APOIO AO CLIENTE.

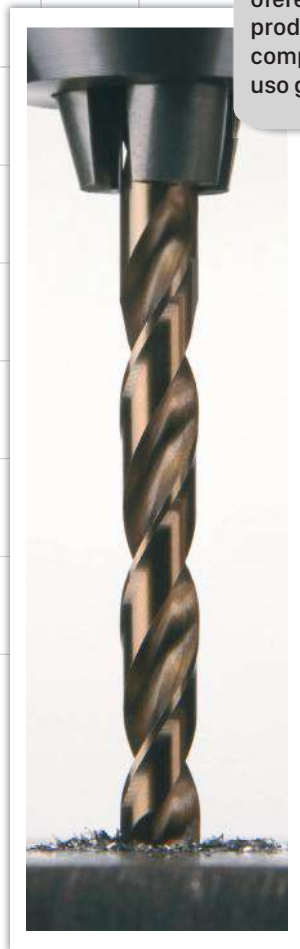



Brocas helicoidais DIN 338 tipo N, HSS-R em embalagens de plástico

cada 10 peças Ø 1,0 - 10,0 mm x 0,5 mm aumentando
cada 5 peças Ø 10,2 - 13,0 mm x 0,5 mm aumentando

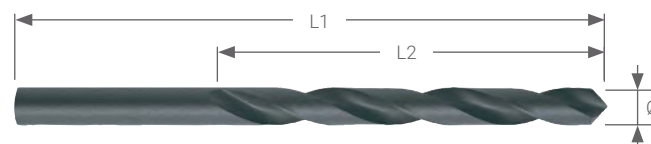

HSS-R	Ø mm	L1 mm	L2 mm	q	PREÇO
R201010TX	Ø 1,0 mm	34,0 mm	12,0 mm	10	€ 0.04
R201015TX	Ø 1,5 mm	40,0 mm	18,0 mm	10	€ 0.04
R201020TX	Ø 2,0 mm	49,0 mm	24,0 mm	10	€ 0.05
R201025TX	Ø 2,5 mm	57,0 mm	30,0 mm	10	€ 0.05
R201030TX	Ø 3,0 mm	61,0 mm	33,0 mm	10	€ 0.05
R201033TX	Ø 3,3 mm	65,0 mm	36,0 mm	10	€ 0.05
R201035TX	Ø 3,5 mm	70,0 mm	39,0 mm	10	€ 0.08
R201040TX	Ø 4,0 mm	75,0 mm	43,0 mm	10	€ 0.09
R201042TX	Ø 4,2 mm	75,0 mm	43,0 mm	10	€ 0.09
R201045TX	Ø 4,5 mm	80,0 mm	47,0 mm	10	€ 0.12
R201050TX	Ø 5,0 mm	86,0 mm	52,0 mm	10	€ 0.16
R201055TX	Ø 5,5 mm	93,0 mm	57,0 mm	10	€ 0.27
R201060TX	Ø 6,0 mm	93,0 mm	57,0 mm	10	€ 0.31
R201065TX	Ø 6,5 mm	101,0 mm	63,0 mm	10	€ 0.33
R201068TX	Ø 6,8 mm	109,0 mm	69,0 mm	10	€ 0.33

HSS-R	Ø mm	L1 mm	L2 mm	q	PREÇO
R201070TX	Ø 7,0 mm	109,0 mm	69,0 mm	10	€ 0.41
R201075TX	Ø 7,5 mm	109,0 mm	69,0 mm	10	€ 0.43
R201080TX	Ø 8,0 mm	117,0 mm	75,0 mm	10	€ 0.61
R201085TX	Ø 8,5 mm	117,0 mm	75,0 mm	10	€ 0.68
R201090TX	Ø 9,0 mm	125,0 mm	81,0 mm	10	€ 0.77
R201095TX	Ø 9,5 mm	125,0 mm	81,0 mm	10	€ 0.81
R201100TX	Ø 10,0 mm	133,0 mm	87,0 mm	10	€ 0.88
R201102TX	Ø 10,2 mm	133,0 mm	87,0 mm	5	€ 0.85
R201105TX	Ø 10,5 mm	133,0 mm	87,0 mm	5	€ 0.88
R201110TX	Ø 11,0 mm	142,0 mm	94,0 mm	5	€ 1.12
R201115TX	Ø 11,5 mm	142,0 mm	94,0 mm	5	€ 1.19
R201120TX	Ø 12,0 mm	151,0 mm	101,0 mm	5	€ 1.36
R201122TX	Ø 12,2 mm	151,0 mm	101,0 mm	5	€ 1.36
R201125TX	Ø 12,5 mm	151,0 mm	101,0 mm	5	€ 1.45
R201130TX	Ø 13,0 mm	151,0 mm	101,0 mm	5	€ 1.52

Jogo de brocas helicoidais DIN 338 tipo N, HSS-R com afiamento em cruz em caixa

170 HSS-R VPE
10 Stück



cada 10 peças Ø 1,0 - 8,0 mm x 0,5 mm aumentando
cada 5 peças Ø 8,5 - 10,0 mm x 0,5 mm aumentando

HSS-R	PREÇO
RA205200	Jogo com 170 brocas helicoidais HSS-R € 64.55

Jogo de brocas helicoidais DIN 338 tipo N, HSS-R em expositor metálico

19 HSS-R VPE
25 Stück

Ø 1,0 - 10,0 mm x 0,5 mm

25 HSS-R VPE
20 Stück

Ø 1,0 - 13,0 mm x 0,5 mm



HSS-R	PREÇO
RA205200	Jogo com 19 brocas helicoidais HSS-R € 10.76
RA205200	Jogo com 25 brocas helicoidais HSS-R € 20.95



Brocas helicoidais DIN 338 tipo N, HSS-G em embalagens de plástico

cada 10 peças Ø 1,0 - 10,0 mm x 0,5 mm aumentando
cada 5 peças Ø 10,2 - 13,0 mm x 0,5 mm aumentando

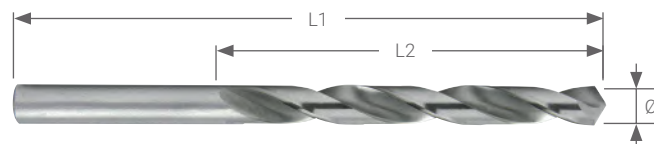

HSS-G	Ø mm	L1 mm	L2 mm	Ø	PREÇO
R214010TX	Ø 1,0 mm	34,0 mm	12,0 mm	10	€ 0.09
R214015TX	Ø 1,5 mm	40,0 mm	18,0 mm	10	€ 0.09
R214020TX	Ø 2,0 mm	49,0 mm	24,0 mm	10	€ 0.09
R214025TX	Ø 2,5 mm	57,0 mm	30,0 mm	10	€ 0.12
R214030TX	Ø 3,0 mm	61,0 mm	33,0 mm	10	€ 0.16
R214033TX	Ø 3,3 mm	65,0 mm	36,0 mm	10	€ 0.16
R214035TX	Ø 3,5 mm	70,0 mm	39,0 mm	10	€ 0.16
R214040TX	Ø 4,0 mm	75,0 mm	43,0 mm	10	€ 0.39
R214042TX	Ø 4,2 mm	75,0 mm	43,0 mm	10	€ 0.39
R214045TX	Ø 4,5 mm	80,0 mm	47,0 mm	10	€ 0.41
R214050TX	Ø 5,0 mm	86,0 mm	52,0 mm	10	€ 0.51
R214055TX	Ø 5,5 mm	93,0 mm	57,0 mm	10	€ 0.56
R214060TX	Ø 6,0 mm	93,0 mm	57,0 mm	10	€ 0.68
R214065TX	Ø 6,5 mm	101,0 mm	63,0 mm	10	€ 0.72
R214068TX	Ø 6,8 mm	109,0 mm	69,0 mm	10	€ 0.72

HSS-G	Ø mm	L1 mm	L2 mm	Ø	PREÇO
R214070TX	Ø 7,0 mm	109,0 mm	69,0 mm	10	€ 0.84
R214075TX	Ø 7,5 mm	109,0 mm	69,0 mm	10	€ 0.92
R214080TX	Ø 8,0 mm	117,0 mm	75,0 mm	10	€ 1.21
R214085TX	Ø 8,5 mm	117,0 mm	75,0 mm	10	€ 1.21
R214090TX	Ø 9,0 mm	125,0 mm	81,0 mm	10	€ 1.45
R214095TX	Ø 9,5 mm	125,0 mm	81,0 mm	10	€ 1.52
R214100TX	Ø 10,0 mm	133,0 mm	87,0 mm	10	€ 1.83
R214102TX	Ø 10,2 mm	133,0 mm	87,0 mm	5	€ 1.88
R214105TX	Ø 10,5 mm	133,0 mm	87,0 mm	5	€ 2.04
R214110TX	Ø 11,0 mm	142,0 mm	94,0 mm	5	€ 2.40
R214115TX	Ø 11,5 mm	142,0 mm	94,0 mm	5	€ 2.51
R214120TX	Ø 12,0 mm	151,0 mm	101,0 mm	5	€ 3.06
R214122TX	Ø 12,2 mm	151,0 mm	101,0 mm	5	€ 2.82
R214125TX	Ø 12,5 mm	151,0 mm	101,0 mm	5	€ 3.04
R214130TX	Ø 13,0 mm	151,0 mm	101,0 mm	5	€ 3.27



Jogo de brocas helicoidais DIN 338 tipo N, HSS-G com afiamento em cruz em caixa



cada 10 peças Ø 1,0 - 8,0 mm x 0,5 mm aumentando
cada 5 peças Ø 8,5 - 10,0 mm x 0,5 mm aumentando

HSS-G	PREÇO
RA214200	Jogo com 170 brocas helicoidais HSS-G € 106.03



Ø 1,0 - 10,0 mm x 0,5 mm

Ø 1,0 - 13,0 mm x 0,5 mm

Jogo de brocas helicoidais DIN 338 tipo N, HSS-G em expositor metálico



HSS-G	PREÇO
RA214214	Jogo com 19 brocas helicoidais HSS-G € 14.95
RA214215	Jogo com 25 brocas helicoidais HSS-G € 31.43



Brocas helicoidais DIN 338 tipo VA, HSSE-Co 5 em embalagens de plástico

cada 10 peças Ø 1,0 - 10,0 mm x 0,5 mm aumentando
cada 5 peças Ø 10,2 - 13,0 mm x 0,5 mm aumentando

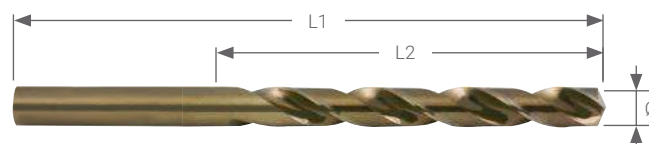

HSS-G	Ø mm	L1 mm	L2 mm	Ø	PREÇO
R215010TX	Ø 1,0 mm	34,0 mm	12,0 mm	10	€ 0.16
R215015TX	Ø 1,5 mm	40,0 mm	18,0 mm	10	€ 0.16
R215020TX	Ø 2,0 mm	49,0 mm	24,0 mm	10	€ 0.27
R215025TX	Ø 2,5 mm	57,0 mm	30,0 mm	10	€ 0.41
R215030TX	Ø 3,0 mm	61,0 mm	33,0 mm	10	€ 0.51
R215033TX	Ø 3,3 mm	65,0 mm	36,0 mm	10	€ 0.61
R215035TX	Ø 3,5 mm	70,0 mm	39,0 mm	10	€ 0.68
R215040TX	Ø 4,0 mm	75,0 mm	43,0 mm	10	€ 0.80
R215042TX	Ø 4,2 mm	75,0 mm	43,0 mm	10	€ 0.84
R215045TX	Ø 4,5 mm	80,0 mm	47,0 mm	10	€ 0.97
R215050TX	Ø 5,0 mm	86,0 mm	52,0 mm	10	€ 1.19
R215055TX	Ø 5,5 mm	93,0 mm	57,0 mm	10	€ 1.45
R215060TX	Ø 6,0 mm	93,0 mm	57,0 mm	10	€ 1.64
R215065TX	Ø 6,5 mm	101,0 mm	63,0 mm	10	€ 1.95
R215068TX	Ø 6,8 mm	109,0 mm	69,0 mm	10	€ 2.30

HSS-G	Ø mm	L1 mm	L2 mm	Ø	PREÇO
R215070TX	Ø 7,0 mm	109,0 mm	69,0 mm	10	€ 2.30
R215075TX	Ø 7,5 mm	109,0 mm	69,0 mm	10	€ 2.75
R215080TX	Ø 8,0 mm	117,0 mm	75,0 mm	10	€ 3.28
R215085TX	Ø 8,5 mm	117,0 mm	75,0 mm	10	€ 3.71
R215090TX	Ø 9,0 mm	125,0 mm	81,0 mm	10	€ 4.27
R215095TX	Ø 9,5 mm	125,0 mm	81,0 mm	10	€ 4.58
R215100TX	Ø 10,0 mm	133,0 mm	87,0 mm	10	€ 5.19
R215102TX	Ø 10,2 mm	133,0 mm	87,0 mm	5	€ 5.36
R215105TX	Ø 10,5 mm	133,0 mm	87,0 mm	5	€ 5.36
R215110TX	Ø 11,0 mm	142,0 mm	94,0 mm	5	€ 6.51
R215115TX	Ø 11,5 mm	142,0 mm	94,0 mm	5	€ 7.01
R215120TX	Ø 12,0 mm	151,0 mm	101,0 mm	5	€ 8.19
R215125TX	Ø 12,5 mm	151,0 mm	101,0 mm	5	€ 8.57
R215130TX	Ø 13,0 mm	151,0 mm	101,0 mm	5	€ 9.13



Jogo de brocas helicoidais DIN 338 tipo VA HSSE-Co 5 com afiamento em cruz em caixa



cada 10 peças Ø 1,0 - 8,0 mm x 0,5 mm aumentando
cada 5 peças Ø 8,5 - 10,0 mm x 0,5 mm aumentando

HSS Co 5	PREÇO
RA215200	Jogo com 170 brocas helicoidais HSSE Co 5 € 246,00



Jogo de brocas helicoidais DIN 338 tipo VA, HSSE-Co 5 em estojo metálico



HSS Co 5	PREÇO
RA215214	Jogo com 19 brocas helicoidais HSSE Co 5 € 35,57
RA215215	Jogo com 25 brocas helicoidais HSSE Co 5 € 73,67



Brocas craneanas HSS com haste Weldon (3/4") profundidade de corte 30.0mm em embalagens de plástico

Profundidade de corte: 30,0 mm
Suporte: haste Weldon 19,0 mm (3/4")
Corte à direita
Unidade de venda: individual em embalagens de plástico



HSS	Ø mm		L1 mm		PREÇO
R108212TX	12,0	19,0	63,0	30,0	€ 11,66
R108214TX	14,0	19,0	63,0	30,0	€ 12,85
R108216TX	16,0	19,0	63,0	30,0	€ 13,72
R108218TX	18,0	19,0	63,0	30,0	€ 14,49
R108220TX	20,0	19,0	63,0	30,0	€ 16,08
R108222TX	22,0	19,0	63,0	30,0	€ 17,04
R108224TX	24,0	19,0	63,0	30,0	€ 18,64
R108226TX	26,0	19,0	63,0	30,0	€ 20,55
R108228TX	28,0	19,0	63,0	30,0	€ 21,44

HSS	Ø mm		L1 mm		PREÇO
R108230TX	30,0	19,0	63,0	30,0	€ 22,16
R108232TX	32,0	19,0	63,0	30,0	€ 23,33

HSS		PREÇO
R108304TX	Pino de acerto Ø 6,35 mm x 77,0 mm para profundidade de corte 30,0 mm referência N° 108 304	€ 3,49



Jogo de brocas craneanas HSS com haste Weldon (3/4") retificado CBN, em caixa metálica

Brocas craneanas com haste Weldon (3/4")
Ø 12,0 mm - 14,0 mm - 16,0 mm - 18,0 mm - 20,0 mm - 22,0 mm
1 pino de acerto Ø 6,35 mm x 77,0 mm
para profundidade de corte 30,0 mm referência N° 108 304

HSS		PREÇO
RA108820	Jogo de brocas craneanas HSS	€ 116,40

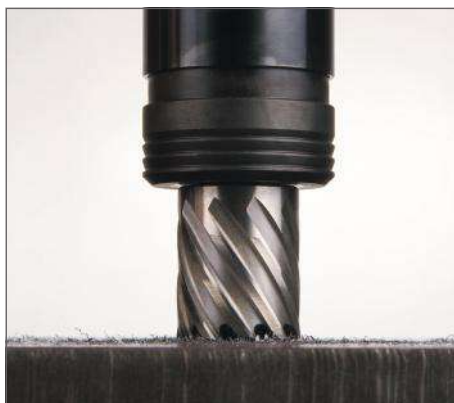



3 tlg./pcs. **HSS** **TiN** **VPE** 5 Stück

Jogo de brocas escalonadas HSS-TiN em estojo de plástico

Tamanho N° 0/9 | Ø 4,0 - 12,0 mm
Tamanho N° 1 | Ø 4,0 - 20,0 mm
Tamanho N° 2 | Ø 4,0 - 30,0 mm



HSS	TiN	PREÇO
RA101126TRO	Brocas escalonadas HSS-TiN tamanhos 0/9, 1, 2	€ 72,31

6 tlg./pcs. **HSS** **VPE** 5 Stück

Jogo de escareadores DIN 335 HSS em estojo de plástico

DIN 335 Tipo C 90°
Ø 6,3 - 8,3 - 10,4 - 12,4 - 16,5 - 20,5 mm



HSS	PREÇO
RA102152RO	Jogo de escareadores DIN 335 HSS DIN 335 Tipo C 90° € 35,37

6 tlg./pcs. **HSS** **TiN** **VPE** 5 Stück

Jogo de escareadores DIN 335 HSS-TiN em estojo de plástico

DIN 335 Tipo C 90°
Ø 6,3 - 8,3 - 10,4 - 12,4 - 16,5 - 20,5 mm



HSS	TiN	PREÇO
RA102152TRO	Jogos de escareadores DIN 335 HSS-TiN DIN 335 Tipo C 90°	€ 40,96

HSS **TiN** **90°** **118°** **3**

Brocas escalonadas HSS+ HSS-TiN, rectificadas por CBN de ranura helicoidal con split point

Tamanho 0/9 | Ø 4,0 - 12,0 mm
Tamanho 1 | Ø 4,0 - 20,0 mm
Tamanho 2 | Ø 6,0 - 30,0 mm



HSS	N.	Ø	L1	PREÇO
RA101050-9TX	0/9	4,0 - 12,0mm	1	€ 16,08
RA101051TX	1	4,0 - 20,0mm	1	€ 22,95
RA101052TX	2	6,0 - 30,0mm	1	€ 36,94
RA101050-9TTX	0/9	4,0 - 12,0mm	1	€ 18,78
RA101051TTX	1	4,0 - 20,0mm	1	€ 26,96
RA101052TTX	2	6,0 - 30,0mm	1	€ 43,80

HSS **TiN** **C** **DIN 335**

Escareadores HSS+ HSS-TiN, DIN 335 tipo C 90°



HSS	Ø 2mm	L1	PREÇO
R102107TX	6,3 mm	45,0 mm	€ 5,08
R102111TX	8,3 mm	50,0 mm	€ 5,42
R102114TX	10,4 mm	50,0 mm	€ 5,83
R102116TX	12,4 mm	56,0 mm	€ 6,10
R102119-1TX	16,5 mm	60,0 mm	€ 8,02
R102121TX	20,5 mm	63,0 mm	€ 9,44
R102107TTX	6,3 mm	45,0 mm	€ 6,10
R102111TTX	8,3 mm	50,0 mm	€ 6,49
R102114TTX	10,4 mm	50,0 mm	€ 7,01
R102116TTX	12,4 mm	56,0 mm	€ 7,25
R102119-1TTX	16,5 mm	60,0 mm	€ 9,60
R102121TTX	20,5 mm	63,0 mm	€ 11,40



Macho de abrir roscas manual M DIN 352 HSS retificado em embalagens de plástico

Cortador preliminar: 5 - 6 fases vértice
Cortador intermédio: 4 - 5 fases vértice
Cortador final: 2 - 3 fases vértice

Roscas: métricas DIN ISO 13
Flancos: com rectificado posterior
Tolerância: ISO 2 / 6 H
Superfície: polida
Corte à direita

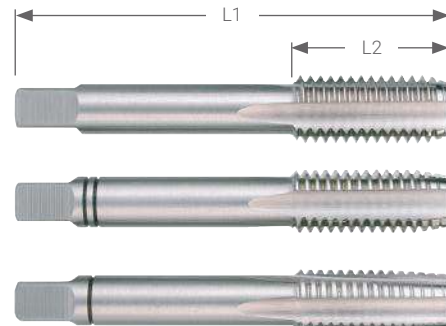

HSS-G	M	Passo	Roscas furo central	L1 mm	L2 mm	PREÇO
R230030TX	M 3	0,50 mm	2,5 mm	40,0 mm	10,0 mm	€ 4,56
R230040TX	M 4	0,70 mm	3,3 mm	45,0 mm	12,0 mm	€ 4,56
R230050TX	M 5	0,80 mm	4,2 mm	50,0 mm	13,0 mm	€ 5,12
R230060TX	M 6	1,00 mm	5 mm	56,0 mm	15,0 mm	€ 5,57
R230080TX	M 8	1,25 mm	6,8 mm	63,0 mm	18,0 mm	€ 5,83
R230100TX	M 10	1,50 mm	8,5 mm	70,0 mm	24,0 mm	€ 7,94

HSS-G	M	Passo	Roscas furo central	L1 mm	L2 mm	PREÇO
R230120TX	M 12	1,75 mm	10,2 mm	75,0 mm	29,0 mm	€ 10,00
R230140TX	M 14	2,00 mm	12 mm	80,0 mm	30,0 mm	€ 12,81
R230160TX	M 16	2,00 mm	14 mm	80,0 mm	32,0 mm	€ 17,88
R230180TX	M 18	2,50 mm	15,5 mm	95,0 mm	40,0 mm	€ 25,66
R230200TX	M 20	2,50 mm	17,5 mm	95,0 mm	40,0 mm	€ 28,09



Caçonete M DIN EN 22568 HSS, rectificado (antigamente DIN 223) em embalagens de plástico

Tipo: molde B fechado, ranhura aberta anteriormente
Roscas: métrico DIN ISO 13
Tolerância: ISO - 6 g
Superfície: polida
Corte à direita

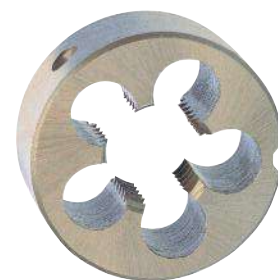

HSS-G	M	Passo mm	Espessura mm	Exterior mm	PREÇO
R237030TX	M 3	0,50 mm	5,0 mm	20,0 mm	€ 2,59
R237040TX	M 4	0,70 mm	5,0 mm	20,0 mm	€ 2,59
R237050TX	M 5	0,80 mm	7,0 mm	20,0 mm	€ 2,59
R237060TX	M 6	1,00 mm	7,0 mm	20,0 mm	€ 2,59
R237080TX	M 8	1,25 mm	9,0 mm	25,0 mm	€ 3,12
R237100TX	M 10	1,50 mm	11,0 mm	38,0 mm	€ 4,12

HSS-G	M	Passo mm	Espessura mm	Exterior mm	PREÇO
R237120TX	M 12	1,75	14,0	38,0	€ 6,07
R237140TX	M 14	2,00	14,0	38,0	€ 7,01
R237160TX	M 16	2,00	18,0	45,0	€ 10,57
R237180TX	M 18	2,50	18,0	45,0	€ 11,10
R237200TX	M 20	2,50	18,0	45,0	€ 11,10



Jogo de desansador de caçonete HSS em estojo metálico

Caçonetes ≈ DIN EN 22568 HSS / M3 - M12
+ desansador de caçonete DIN 225 / 25 x 9



HSS		PREÇO
RA245014	Jogo de machos de abrir roscas manuais HSS - 8 peças	€ 25,81



Jogo de machos de abrir roscas manuais HSS em caixa metálica

Jogo de ferramentas de abrir roscas com 31 peças cada conjunto com 3 peças de machos de abrir roscas manual M DIN 352 / M3 - M12 + caçonetes ≈ DIN EN 22568 HSS / M3 - M12 + desansador de caçonete DIN 225 - 25 x 9 mm + 1 desansador de machos DIN 1814 tamanho 11/2 + 1 chave de fendas



HSS		PREÇO
RA245013	Jogo de machos de abrir roscas manual HSS - 31 peças	€ 83,34



Jogo de machos de abrir roscas manuais HSS em caixa plástica

Jogo de ferramentas de abrir roscas com 45 peças cada conjunto com 3 peças de machos de abrir roscas manual M DIN 352 HSS / M3 - M12 + caçonetes ≈ DIN EN 22568 HSS / M3 - M12 + desansador de caçonete DIN 225 - 20 x 5 / 20 x 7 / 25 x 9 / 30 x 11 / 38 x 14 mm + brocas helicoidais DIN 338 Tipo N - Ø 2,5 / 3,3 / 4,2 / 5,0 / 6,8 / 8,5 / 10,2 mm + 2 desansador de machos DIN 1814 Gr. 1 und Gr. 2 + 1 Desansador com roquete - tamanho 1 + 1 chave de fendas + 1 contafios



HSS		PREÇO
RA245021	Jogo de machos de abrir roscas manual HSS - 45 peças	€ 107,19



Conjunto de ferramentas para abrir roscas HSS em caixa metálica

Jogo de ferramentas de abrir roscas com 54 peças
cada conjunto com 3 peças de machos de abrir roscas manual M DIN 352 HSS / M3 - M20 + caçonetes ≈ DIN EN 22568 HSS / M3 - M20 + desandador de caçonete DIN 225 / 20 x 5 / 20 x 7 / 25 x 9 / 30 x 11 / 38 x 14 / 45 x 18 mm
+2 desandador de machos DIN 1814 tamanho 1 + 3
+ 1 chave de fendas + 1 contafios



HSS		PREÇO
RA245040	Jogo de machos de abrir roscas manual HSS - 54 peças	€ 271,93



Macho de máquina de abrir roscas M DIN 371/376 molde B - HSS retificado

Macho de máquina de abrir roscas com haste reforçada para roscas de passagem
Vértice: molde B de 4 - 5 fases com de vértice descascador
Roscas: métricas DIN ISO 13
Flancos: com retificado posterior
Unidade de venda: individual em embalagens de plástico

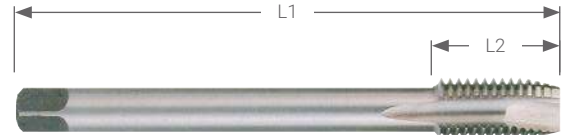

HSS	M	Passo mm	Roscas furo central mm	L1 mm	L2 mm	Ø-Haste mm	PREÇO
R232030TX	M 3	0,50 mm	2,5 mm	56,0 mm	11,0 mm	3,5 mm	€ 2,83
R232040TX	M 4	0,70 mm	3,3 mm	63,0 mm	13,0 mm	4,5 mm	€ 2,83
R232050TX	M 5	0,80 mm	4,2 mm	70,0 mm	16,0 mm	6,0 mm	€ 2,83
R232060TX	M 6	1,00 mm	5,0 mm	80,0 mm	19,0 mm	6,0 mm	€ 3,10

HSS	M	Passo mm	Roscas furo central mm	L1 mm	L2 mm	Ø-Haste mm	PREÇO
R232080TX	M 8	1,25 mm	6,8 mm	90,0 mm	22,0 mm	8,0 mm	€ 3,90
R232100TX	M 10	1,50 mm	8,5 mm	100,0 mm	24,0 mm	10 mm	€ 4,76
R232120TX	M 12	1,75 mm	10,2 mm	110,0 mm	28,0 mm	9,0 mm	€ 6,59



Macho de máquina de abrir roscas M DIN 371/376 molde C/35° RSP - HSS retificado

Macho de máquina de abrir roscas com haste reforçada e fresas helicoidais à direita 35° RSP para roscas para furos cegos
Vértice: molde C / 35° RSP de 2 - 3 fases
Roscas: métricas DIN ISO 13
Flancos: com retificado posterior
Unidade de venda: individual em embalagens de plástico

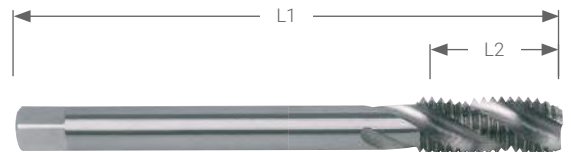

HSS	M	Passo mm	Roscas furo central mm	L1 mm	L2 mm	Ø-Haste mm	PREÇO
R234030TX	M 3	0,50 mm	2,5 mm	56,0 mm	11,0 mm	3,5 mm	€ 3,39
R234040TX	M 4	0,70 mm	3,3 mm	63,0 mm	13,0 mm	4,5 mm	€ 3,39
R234050TX	M 5	0,80 mm	4,2 mm	70,0 mm	16,0 mm	6,0 mm	€ 3,39
R234060TX	M 6	1,00 mm	5,0 mm	80,0 mm	19,0 mm	6,0 mm	€ 3,58

HSS	M	Passo mm	Roscas furo central mm	L1 mm	L2 mm	Ø-Haste mm	PREÇO
R234080TX	M 8	1,25 mm	6,8 mm	90,0 mm	18,0 mm	8,0 mm	€ 3,96
R234100TX	M 10	1,50 mm	8,5 mm	100,0 mm	24,0 mm	10,0 mm	€ 4,52
R233120TX	M 12	1,75 mm	10,2 mm	110,0 mm	28,0 mm	9,0 mm	€ 7,21



Ø 1,0 - 10,0 mm x 0,5 mm



Ø 1,0 - 13,0 mm x 0,5 mm

Jogo de machos de máquina de abrir roscas em estojo plástico



HSSE Co 5		PREÇO
RA245057ETX	M DIN 371 / 376 - tipo B / M3 - M12	€ 42,79
RA245058ETX	M DIN 371 / 376 - tipo C / 35° RSP / M3 - M12	€ 45,50



Macho de máquina de abrir roscas M DIN 371/376 molde B - HSSE-Co 5 retificado

Macho de máquina de abrir roscas com haste reforçada para roscas de passagem
Vértice: molde B de 4 - 5 fases com de vértice descascador
Roscas: métricas DIN ISO 13
Flancos: com retificado posterior



HSSE Co 5	M	Passo mm	Roscas furo central mm	L1 mm	L2 mm	Ø-Haste mm	PREÇO
R232030ETX	M 3	0,50 mm	2,5 mm	56,0 mm	11,0 mm	3,5 mm	€ 3,98
R232040ETX	M 4	0,70 mm	3,3 mm	63,0 mm	13,0 mm	4,5 mm	€ 3,98
R232050ETX	M 5	0,80 mm	4,2 mm	70,0 mm	16,0 mm	6,0 mm	€ 3,98
R232060ETX	M 6	1,00 mm	5,0 mm	80,0 mm	19,0 mm	6,0 mm	€ 4,30

HSSE Co 5	M	Passo mm	Roscas furo central mm	L1 mm	L2 mm	Ø-Haste mm	PREÇO
R232080ETX	M 8	1,25 mm	6,8 mm	90,0 mm	22,0 mm	8,0 mm	€ 5,42
R232100ETX	M 10	1,50 mm	8,5 mm	100,0 mm	24,0 mm	10,0 mm	€ 6,57
R232120ETX	M 12	1,75 mm	10,2 mm	110,0 mm	28,0 mm	9,0 mm	€ 8,83



Macho de máquina de abrir roscas M DIN 371 / 376 molde C / 35° RSP - HSSE-Co 5 retificado

Macho de máquina de abrir roscas com haste reforçada e fresas helicoidais à direita 35° RSP para roscas para furos cegos.
Vértice: molde C / 35° RSP de 2 - 3 fases
Roscas: métricas DIN ISO 13
Flancos: com retificado posterior

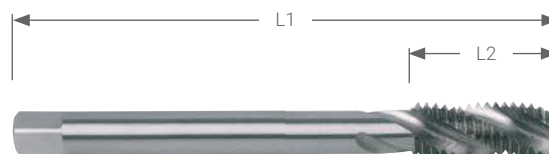

HSSE Co 5	M	Passo mm	Roscas furo central mm	L1 mm	L2 mm	Ø-Haste mm	PREÇO
R234030ETX	M 3	0,50 mm	2,5 mm	56,0 mm	11,0 mm	3,5 mm	€ 5,57
R234040ETX	M 4	0,70 mm	3,3 mm	63,0 mm	13,0 mm	4,5 mm	€ 5,57
R234050ETX	M 5	0,80 mm	4,2 mm	70,0 mm	16,0 mm	6,0 mm	€ 5,57
R234060ETX	M 6	1,00 mm	5,0 mm	80,0 mm	19,0 mm	6,0 mm	€ 5,77

HSSE Co 5	M	Passo mm	Roscas furo central mm	L1 mm	L2 mm	Ø-Haste mm	PREÇO
R234080ETX	M 8	1,25	6,8	90,0	22,0	8,0	6,57
R234100ETX	M 10	1,50	8,5	100,0	24,0	10,0	7,47
R233120ETX	M 12	1,75	10,2	110,0	28,0	9,0	9,30

Ferramentas de corte e desbaste

- ▶ Gama completa de produtos de corte e desbaste.
- ▶ Geometrias distintas.
- ▶ Aplicações diversas, em vários setores profissionais.



shaping your dreams



☎ PARA MAIS INFORMAÇÕES TÉCNICAS CONTACTE O NOSSO SERVIÇO DE APOIO AO CLIENTE.

TYPES OF SPIRAL (OR HELIX) ANGLES
 TYPES D'ANGLES EN SPIRALES (OU HELICES)
 ARTEN VON SPIRALWINKELN
 TIPOS DE ÂNGULOS DE ESPIRAL (O HÉLICE)
 ТИПЫ УГЛОВ НАКЛОНА СПИРАЛИ

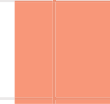
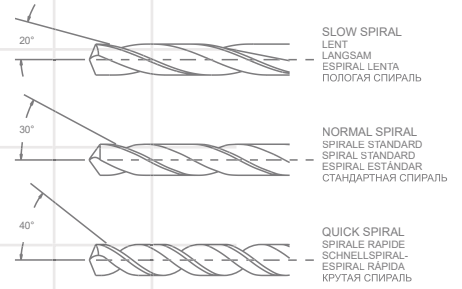

ideal para perfuração de precisão

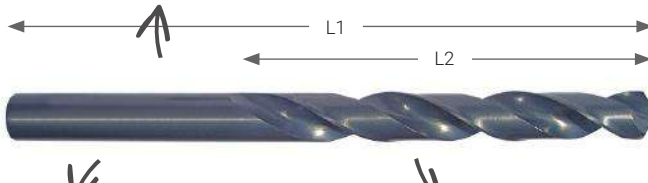

101

extremamente versátil

alto desempenho

HSS	DIN 338	5xD	N	118°
h8	30°	ACABAMENTO AZUL	< 3.0MM PONTA STANDARD	≥ 3.0MM

BROCAS HELICOIDAIS DIN 338 TIPO N. HSS - 101

SAP	Ø mm	L1 mm	L2 mm	✎	PREÇO
1010030	0.3	19	3	10	€ 0.97
1010035	0.35	19	4	10	€ 0.97
1010040	0.4	20	5	10	€ 0.97
1010045	0.45	20	5	10	€ 0.97
1010050	0.5	22	6	10	€ 0.97
1010055	0.55	24	7	10	€ 0.97
1010058	0.58	24	7	10	€ 3.92
1010060	0.6	24	7	10	€ 0.97
1010075	0.75	28	9	10	€ 0.97
1010080	0.8	30	10	10	€ 0.97
1010090	0.9	32	11	10	€ 0.97
1010100	1	34	12	10	€ 0.85
1010105	1.05	34	12	10	€ 0.85
1010110	1.1	36	14	10	€ 0.85
1010115	1.15	36	14	10	€ 0.85
1010120	1.2	38	16	10	€ 0.85
1010125	1.25	38	16	10	€ 0.85
1010130	1.3	38	16	10	€ 0.85
1010135	1.35	40	18	10	€ 0.85
1010140	1.4	40	18	10	€ 0.85
1010145	1.45	40	18	10	€ 0.85
1010150	1.5	40	18	10	€ 0.85
1010155	1.55	43	20	10	€ 0.85

SAP	Ø mm	L1 mm	L2 mm	✎	PREÇO
1010160	1.6	43	20	10	€ 0.85
1010165	1.65	43	20	10	€ 0.85
1010170	1.7	43	20	10	€ 0.85
1010175	1.75	46	22	10	€ 0.85
1010180	1.8	46	22	10	€ 0.85
1010185	1.85	46	22	10	€ 0.85
1010190	1.9	46	22	10	€ 0.85
1010200	2	49	24	10	€ 0.85
1010205	2.05	49	24	10	€ 0.85
1010210	2.1	49	24	10	€ 0.85
1010215	2.15	53	27	10	€ 0.85
1010220	2.2	53	27	10	€ 0.85
1010225	2.25	53	27	10	€ 0.85
1010230	2.3	53	27	10	€ 0.85
1010235	2.35	53	27	10	€ 0.85
1010240	2.4	57	30	10	€ 0.85
1010245	2.45	57	30	10	€ 0.85
1010250	2.5	57	30	10	€ 0.85
1010255	2.55	57	30	10	€ 0.88
1010260	2.6	57	30	10	€ 0.88
1010265	2.65	57	30	10	€ 0.88
1010270	2.7	61	33	10	€ 0.88
1010275	2.75	61	33	10	€ 0.88

SAP	Ø mm	L1 mm	L2 mm	ñ	PREÇO
1010280	2.8	61	33	10	€ 0.88
1010285	2.85	61	33	10	€ 0.88
1010290	2.9	61	33	10	€ 0.88
1010295	2.95	61	33	10	€ 0.88
1010300	3	61	33	10	€ 0.88
1010310	3.1	65	36	10	€ 0.95
1010320	3.2	65	36	10	€ 0.95
1010325	3.25	65	36	10	€ 0.95
1010330	3.3	65	36	10	€ 0.95
1010340	3.4	70	39	10	€ 0.95
1010350	3.5	70	39	10	€ 1.02
1010360	3.6	70	39	10	€ 1.07
1010370	3.7	70	39	10	€ 1.07
1010375	3.75	70	39	10	€ 1.08
1010380	3.8	75	43	10	€ 1.18
1010390	3.9	75	43	10	€ 1.18
1010400	4	75	43	10	€ 1.23
1010410	4.1	75	43	10	€ 1.23
1010420	4.2	75	43	10	€ 1.23
1010425	4.25	75	43	10	€ 1.42
1010430	4.3	80	47	10	€ 1.42
1010440	4.4	80	47	10	€ 1.42
1010450	4.5	80	47	10	€ 1.42
1010460	4.6	80	47	10	€ 1.53
1010470	4.7	80	47	10	€ 1.53
1010475	4.75	80	47	10	€ 1.43
1010480	4.8	86	52	10	€ 1.63
1010490	4.9	86	52	10	€ 1.63
1010500	5	86	52	10	€ 1.63
1010510	5.1	86	52	10	€ 1.63
1010520	5.2	86	52	10	€ 1.63
1010525	5.25	86	52	10	€ 1.97
1010530	5.3	86	52	10	€ 1.97
1010540	5.4	93	57	10	€ 2.12
1010550	5.5	93	57	10	€ 2.12
1010560	5.6	93	57	10	€ 2.12
1010570	5.7	93	57	10	€ 2.12
1010575	5.75	93	57	10	€ 2.12
1010580	5.8	93	57	10	€ 2.12
1010590	5.9	93	57	10	€ 2.18
1010600	6	93	57	10	€ 2.18
1010610	6.1	101	63	10	€ 2.38
1010620	6.2	101	63	10	€ 2.38
1010625	6.25	101	63	10	€ 2.38
1010630	6.3	101	63	10	€ 2.38
1010640	6.4	101	63	10	€ 2.38
1010650	6.5	101	63	10	€ 2.38
1010660	6.6	101	63	10	€ 2.65
1010670	6.7	101	63	10	€ 2.65
1010675	6.75	109	69	10	€ 2.93
1010680	6.8	109	69	10	€ 2.93
1010690	6.9	109	69	10	€ 2.93
1010700	7	109	69	10	€ 2.93
1010710	7.1	109	69	10	€ 2.93
1010720	7.2	109	69	10	€ 3.12
1010725	7.25	109	69	10	€ 2.90
1010730	7.3	109	69	10	€ 3.12
1010740	7.4	109	69	10	€ 3.12
1010750	7.5	109	69	10	€ 3.32
1010760	7.6	117	75	10	€ 3.58
1010770	7.7	117	75	10	€ 3.58
1010780	7.8	117	75	10	€ 3.58
1010790	7.9	117	75	10	€ 3.58
1010800	8	117	75	10	€ 3.65
1010810	8.1	117	75	10	€ 3.77
1010820	8.2	117	75	10	€ 3.77
1010825	8.25	117	75	10	€ 4.02
1010830	8.3	117	75	10	€ 4.02
1010840	8.4	117	75	10	€ 4.02
1010850	8.5	117	75	10	€ 4.02
1010860	8.6	125	81	10	€ 4.18
1010870	8.7	125	81	10	€ 4.18
1010875	8.75	125	81	10	€ 4.18
1010880	8.8	125	81	10	€ 4.18
1010890	8.9	125	81	10	€ 4.33

SAP	Ø mm	L1 mm	L2 mm	ñ	PREÇO
1010900	9	125	81	10	€ 4.50
1010910	9.1	125	81	10	€ 5.08
1010920	9.2	125	81	10	€ 5.08
1010925	9.25	125	81	10	€ 5.08
1010930	9.3	125	81	10	€ 5.08
1010940	9.4	125	81	10	€ 5.08
1010950	9.5	125	81	10	€ 5.08
1010960	9.6	133	87	10	€ 5.28
1010970	9.7	133	87	10	€ 5.28
1010975	9.75	133	87	10	€ 5.28
1010980	9.8	133	87	10	€ 5.28
1010990	9.9	133	87	10	€ 5.28
1011000	10	133	87	5	€ 5.33
1011010	10.1	133	87	5	€ 5.68
1011020	10.2	133	87	5	€ 5.68
1011025	10.25	133	87	5	€ 5.78
1011030	10.3	133	87	5	€ 5.78
1011040	10.4	133	87	5	€ 5.78
1011050	10.5	133	87	5	€ 5.87
1011060	10.6	133	87	5	€ 6.13
1011070	10.7	142	94	5	€ 6.13
1011075	10.75	142	94	5	€ 6.32
1011090	10.9	142	94	5	€ 6.53
1011100	11	142	94	5	€ 6.98
1011110	11.1	142	94	5	€ 7.02
1011120	11.2	142	94	5	€ 7.05
1011130	11.3	142	94	5	€ 7.15
1011140	11.4	142	94	5	€ 7.20
1011150	11.5	142	94	5	€ 7.27
1011160	11.6	142	94	5	€ 7.58
1011170	11.7	142	94	5	€ 7.72
1011175	11.75	142	94	5	€ 7.30
1011180	11.8	142	94	5	€ 7.92
1011190	11.9	151	101	5	€ 8.00
1011200	12	151	101	5	€ 8.05
1011210	12.1	151	101	5	€ 8.43
1011220	12.2	151	101	5	€ 8.43
1011225	12.25	151	101	5	€ 8.63
1011230	12.3	151	101	5	€ 8.72
1011240	12.4	151	101	5	€ 8.95
1011250	12.5	151	101	5	€ 9.23
1011260	12.6	151	101	5	€ 9.33
1011270	12.7	151	101	5	€ 9.38
1011275	12.75	151	101	5	€ 9.95
1011280	12.8	151	101	5	€ 9.53
1011290	12.9	151	101	5	€ 9.90
1011300	13	151	101	1	€ 9.78
1011310	13.1	151	101	1	€ 10.12
1011320	13.2	151	101	1	€ 10.47
1011325	13.25	160	108	1	€ 10.78
1011330	13.3	160	108	1	€ 11.23
1011340	13.4	160	108	1	€ 11.32
1011350	13.5	160	108	1	€ 11.53
1011360	13.6	160	108	1	€ 11.85
1011370	13.7	160	108	1	€ 12.23
1011380	13.8	160	108	1	€ 12.72
1011390	13.9	160	108	1	€ 13.02
1011400	14	160	108	1	€ 13.07
1011425	14.25	169	114	1	€ 16.08
1011450	14.5	169	114	1	€ 18.53
1011475	14.75	169	114	1	€ 22.32
1011500	15	169	114	1	€ 22.32
1011525	15.25	178	120	1	€ 23.82
1011550	15.5	178	120	1	€ 23.82
1011575	15.75	178	120	1	€ 24.18
1011600	16	178	120	1	€ 24.18
1011650	16.5	184	125	1	€ 25.53
1011700	17	184	125	1	€ 25.78
1011750	17.5	191	130	1	€ 27.68
1011800	18	191	130	1	€ 28.00
1011850	18.5	198	135	1	€ 29.37
1011900	19	198	135	1	€ 29.82
1011950	19.5	205	140	1	€ 32.97
1012000	20	205	140	1	€ 33.30

permite fazer furos profundos no metal

122
124



máxima precisão sem necessidade de pre-perfuração

HSS	ISO 3292	15-20 xD
N	118°	h8
30°	ACABAMENTO AZUL	PONTA STANDARD

BROCAS HELICOIDAIS HSS EXTRA LONGAS - 122-124

SAP	Ø mm	L1 mm	L2 mm	fl	PREÇO
1220150	1.5	160	100	10	€ 5.38
1220200	2	160	100	10	€ 5.38
1220250	2.5	160	100	10	€ 5.38
1220300	3	160	100	10	€ 7.05
1220350	3.5	160	100	10	€ 6.72
1220400	4	160	100	10	€ 6.72
1220450	4.5	160	100	10	€ 6.72
1220500	5	160	100	10	€ 6.72
1220550	5.5	160	100	10	€ 6.72
1220600	6	160	100	10	€ 8.85
1230200	2	200	160	10	€ 7.78
1230250	2.5	200	160	10	€ 7.78
1230300	3	200	160	10	€ 9.78
1230350	3.5	200	160	10	€ 9.78
1230400	4	200	160	10	€ 9.78
1230450	4.5	200	160	10	€ 9.78
1230500	5	200	160	10	€ 9.78
1230550	5.5	200	160	10	€ 10.12
1230600	6	200	160	10	€ 13.03
1230650	6.5	200	160	10	€ 13.03
1230700	7	200	160	10	€ 14.72
1230750	7.5	200	160	10	€ 14.72
1230800	8	200	160	10	€ 14.72
1230850	8.5	200	160	10	€ 17.37
1230900	9	200	160	10	€ 17.37
1230950	9.5	200	160	10	€ 17.37
1231000	10	200	160	5	€ 17.37
1240300	3	250	200	10	€ 12.93

SAP	Ø mm	L1 mm	L2 mm	fl	PREÇO
1240350	3.5	250	200	10	€ 12.93
1240400	4	250	200	10	€ 12.93
1240450	4.5	250	200	10	€ 17.08
1240500	5	250	200	10	€ 15.20
1240550	5.5	250	200	10	€ 15.20
1240600	6	250	200	10	€ 16.63
1240625	6.25	250	200	10	€ 16.18
1240650	6.5	250	200	10	€ 16.63
1240675	6.75	250	200	10	€ 6.50
1240700	7	250	200	10	€ 18.95
1240725	7.25	250	200	10	€ 6.77
1240750	7.5	250	200	10	€ 18.95
1240775	7.75	250	200	10	€ 9.33
1240800	8	250	200	10	€ 18.95
1240825	8.25	250	200	10	€ 10.62
1240850	8.5	250	200	10	€ 23.45
1240875	8.75	250	200	10	€ 9.97
1240900	9	250	200	10	€ 23.45
1240925	9.25	250	200	10	€ 8.87
1240950	9.5	250	200	10	€ 23.45
1240975	9.75	250	200	10	€ 12.27
1241000	10	250	200	5	€ 23.45
1241050	10.5	250	200	5	€ 26.15
1241100	11	250	200	5	€ 26.15
1241150	11.5	250	200	5	€ 26.15
1241200	12	250	200	5	€ 26.15
1241250	12.5	250	200	5	€ 29.32
1241300	13	250	200	5	€ 32.23

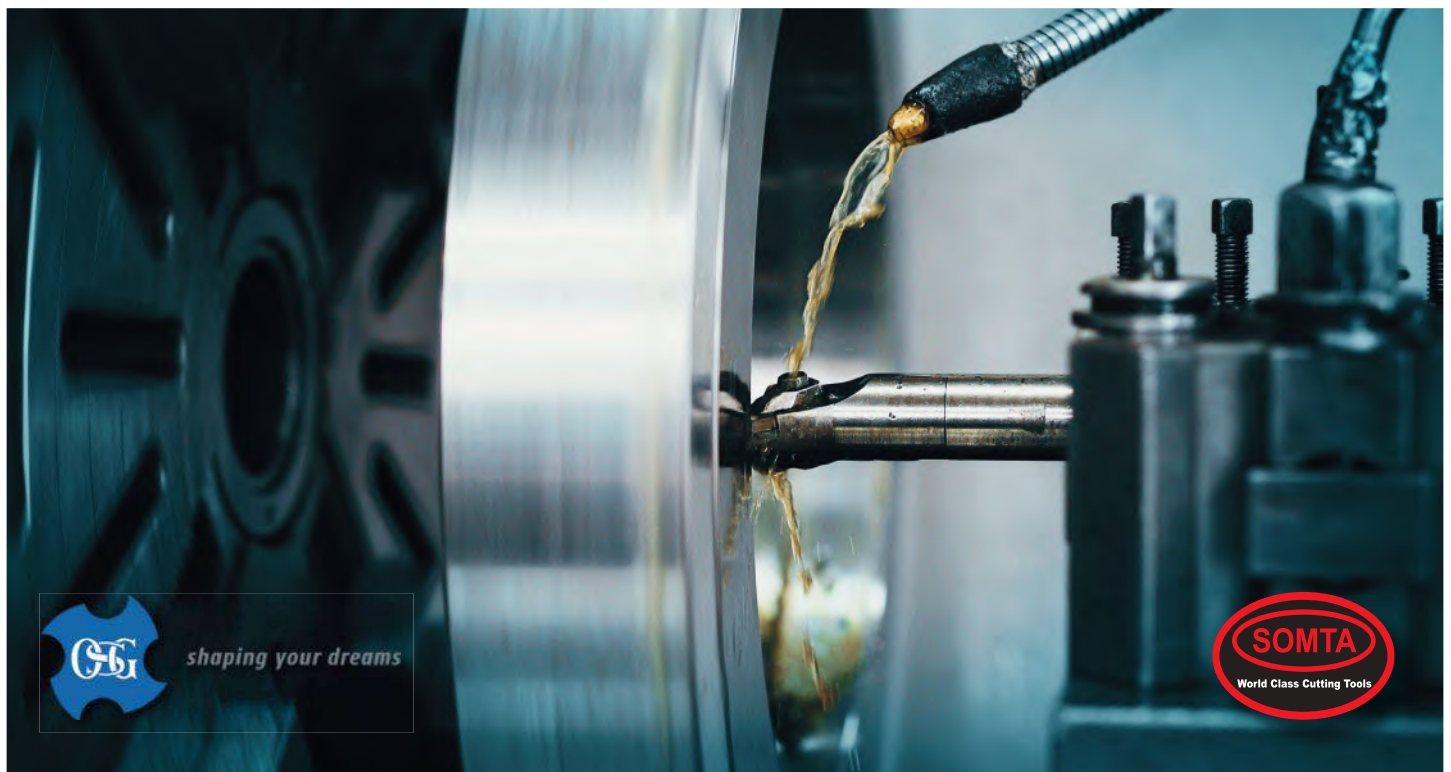



BROCAS HELICOIDAIS DIN 338 TIPO N, HSS CO5 - 177

SAP	Ø mm	L1 mm	L2 mm	fl	PREÇO
1770100	1	34	12	10	€ 1.02
1770150	1.5	40	18	10	€ 1.70
1770160	1.6	43	20	10	€ 1.70
1770170	1.7	43	20	10	€ 1.70
1770180	1.8	46	22	10	€ 1.70
1770190	1.9	46	22	10	€ 1.70
1770200	2	49	24	10	€ 1.70
1770210	2.1	49	24	10	€ 1.70
1770220	2.2	53	27	10	€ 1.70
1770230	2.3	53	27	10	€ 1.70
1770240	2.4	57	30	10	€ 1.70
1770250	2.5	57	30	10	€ 1.70
1770260	2.6	57	30	10	€ 1.70
1770270	2.7	61	33	10	€ 1.73
1770280	2.8	61	33	10	€ 1.73
1770290	2.9	61	33	10	€ 1.73
1770300	3	61	33	10	€ 1.73
1770310	3.1	65	36	10	€ 1.75
1770320	3.2	65	36	10	€ 1.75
1770330	3.3	65	36	10	€ 1.75
1770340	3.4	70	39	10	€ 1.85
1770350	3.5	70	39	10	€ 1.85
1770360	3.6	70	39	10	€ 1.95
1770370	3.7	70	39	10	€ 1.95
1770380	3.8	75	43	10	€ 1.98
1770390	3.9	75	43	10	€ 2.03
1770400	4	75	43	10	€ 2.12
1770410	4.1	75	43	10	€ 2.13
1770420	4.2	75	43	10	€ 2.23
1770430	4.3	80	47	10	€ 2.53
1770440	4.4	80	47	10	€ 2.53
1770450	4.5	80	47	10	€ 2.53
1770460	4.6	80	47	10	€ 2.58
1770470	4.7	80	47	10	€ 2.58
1770480	4.8	86	52	10	€ 2.60
1770490	4.9	86	52	10	€ 2.63
1770500	5	86	52	10	€ 2.63
1770510	5.1	86	52	10	€ 2.72
1770520	5.2	86	52	10	€ 2.72
1770530	5.3	86	52	10	€ 3.02
1770540	5.4	93	57	10	€ 3.32
1770550	5.5	93	57	10	€ 3.32
1770560	5.6	93	57	10	€ 3.32
1770570	5.7	93	57	10	€ 3.33
1770580	5.8	93	57	10	€ 3.42
1770590	5.9	93	57	10	€ 3.62
1770600	6	93	57	10	€ 3.70
1770610	6.1	101	63	10	€ 3.75
1770620	6.2	101	63	10	€ 3.75
1770630	6.3	101	63	10	€ 3.92
1770640	6.4	101	63	10	€ 3.92
1770650	6.5	101	63	10	€ 3.97
1770660	6.6	101	63	10	€ 4.32
1770670	6.7	101	63	10	€ 4.32
1770680	6.8	109	69	10	€ 4.77
1770690	6.9	109	69	10	€ 4.82
1770700	7	109	69	10	€ 4.87
1770710	7.1	109	69	10	€ 4.92
1770720	7.2	109	69	10	€ 4.97

SAP	Ø mm	L1 mm	L2 mm	fl	PREÇO
1770730	7.3	109	69	10	€ 5.47
1770740	7.4	109	69	10	€ 5.52
1770750	7.5	109	69	10	€ 5.62
1770760	7.6	117	75	10	€ 5.77
1770770	7.7	117	75	10	€ 5.82
1770780	7.8	117	75	10	€ 5.88
1770790	7.9	117	75	10	€ 5.97
1770800	8	117	75	10	€ 5.98
1770810	8.1	117	75	10	€ 6.12
1770820	8.2	117	75	10	€ 6.20
1770830	8.3	117	75	10	€ 6.32
1770840	8.4	117	75	10	€ 6.37
1770850	8.5	117	75	10	€ 6.47
1770860	8.6	125	81	10	€ 6.67
1770870	8.7	125	81	10	€ 6.82
1770880	8.8	125	81	10	€ 6.92
1770890	8.9	125	81	10	€ 7.08
1770900	9	125	81	10	€ 7.15
1770910	9.1	125	81	10	€ 7.30
1770920	9.2	125	81	10	€ 7.43
1770930	9.3	125	81	10	€ 7.52
1770940	9.4	125	81	10	€ 7.67
1770950	9.5	125	81	10	€ 7.72
1770960	9.6	133	87	10	€ 7.88
1770970	9.7	133	87	10	€ 8.05
1770980	9.8	133	87	10	€ 8.15
1770990	9.9	133	87	10	€ 8.37
1771000	10	133	87	5	€ 8.57
1771010	10.1	133	87	5	€ 8.72
1771020	10.2	133	87	5	€ 8.85
1771030	10.3	133	87	5	€ 8.95
1771040	10.4	133	87	5	€ 9.10
1771050	10.5	133	87	5	€ 9.18
1771060	10.6	133	87	5	€ 9.33
1771070	10.7	142	94	5	€ 9.92
1771080	10.8	142	94	5	€ 10.32
1771090	10.9	142	94	5	€ 10.70
1771100	11.0	142	94	5	€ 11.13
1771110	11.1	142	94	5	€ 11.22
1771120	11.2	142	94	5	€ 11.28
1771130	11.3	142	94	5	€ 11.37
1771140	11.4	142	94	5	€ 11.53
1771150	11.5	142	94	5	€ 11.68
1771160	11.6	142	94	5	€ 11.92
1771170	11.7	142	94	5	€ 12.12
1771180	11.8	142	94	5	€ 12.27
1771190	11.9	151	101	5	€ 12.48
1771200	12	151	101	5	€ 12.62
1771210	12.1	151	101	5	€ 12.88
1771220	12.2	151	101	5	€ 13.27
1771230	12.3	151	101	5	€ 13.50
1771240	12.4	151	101	5	€ 13.82
1771250	12.5	151	101	5	€ 14.18
1771260	12.6	151	101	5	€ 14.33
1771270	12.7	151	101	5	€ 14.52
1771280	12.8	151	101	5	€ 14.78
1771290	12.9	151	101	5	€ 14.93
1771300	13	151	101	1	€ 15.13

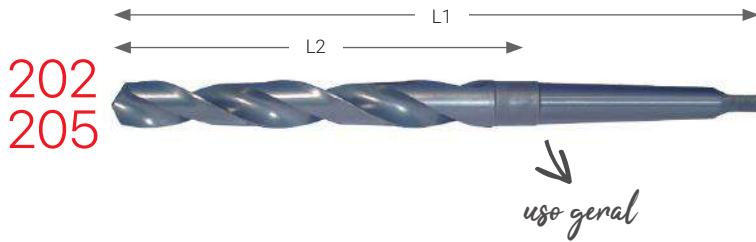

BROCAS HELICOIDAIS COM CONE MORSE DIN 345 TIPO N, HSS - 202-205

SAP	Ø mm	Cone Morse	L1 mm	L2 mm	fl	PREÇO
2021800	18	N.2	228	130	1	€ 27.38
2021825	18,25	N.2	233	135	1	€ 19.87
2021850	18,5	N.2	233	135	1	€ 28.92
2021875	18,75	N.2	233	135	1	€ 20.23
2021900	19	N.2	233	135	1	€ 29.47
2021925	19,25	N.2	238	140	1	€ 22.58
2021950	19,5	N.2	238	140	1	€ 32.83
2021975	19,75	N.2	238	140	1	€ 22.80
2022000	20	N.2	238	140	1	€ 33.08
2022050	20,5	N.2	243	145	1	€ 35.43
2022075	20,75	N.2	243	145	1	€ 24.42
2022100	21	N.2	243	145	1	€ 35.52
2022125	21,25	N.2	248	150	1	€ 26.32
2022150	21,5	N.2	248	150	1	€ 38.02
2022175	21,75	N.2	248	150	1	€ 32.13
2022200	22	N.2	248	150	1	€ 38.58
2022225	22,25	N.2	248	150	1	€ 27.22
2022250	22,5	N.2	253	155	1	€ 42.63
2022275	22,75	N.2	253	155	1	€ 29.55
2022300	23	N.2	253	155	1	€ 43.13
2032325	23,25	N.3	253	155	1	€ 30.67
2032350	23,5	N.3	276	155	1	€ 44.72
2032375	23,75	N.3	276	155	1	€ 32.87
2032400	24	N.3	281	160	1	€ 47.85
2032425	24,25	N.3	281	160	1	€ 32.98
2032450	24,5	N.3	281	160	1	€ 48.07
2032475	24,75	N.3	281	160	1	€ 23.03
2032500	25	N.3	281	160	1	€ 49.45
2032550	25,5	N.3	286	165	1	€ 54.83
2032600	26	N.3	286	165	1	€ 54.83
2032650	26,5	N.3	286	165	1	€ 55.08
2032700	27	N.3	291	170	1	€ 56.92
2032750	27,5	N.3	291	170	1	€ 58.62
2032800	28	N.3	291	170	1	€ 59.62
2032850	28,5	N.3	296	175	1	€ 67.72
2032900	29	N.3	296	175	1	€ 69.47
2032950	29,5	N.3	296	175	1	€ 70.57
2033000	30	N.3	296	175	1	€ 71.52
2033050	30,5	N.3	301	190	1	€ 72.73
2033100	31	N.3	301	190	1	€ 73.48
2033150	31,5	N.3	301	190	1	€ 77.22
2033200	32	N.3	306	185	1	€ 83.43
2043200	32	N.4	334	185	1	€ 85.02
2043250	32,5	N.4	334	185	1	€ 85.77
2043300	33	N.4	334	185	1	€ 87.87
2043350	33,5	N.4	334	185	1	€ 91.75
2043400	34	N.4	339	190	1	€ 93.70
2043450	34,5	N.4	339	190	1	€ 96.45
2043500	35	N.4	339	190	1	€ 98.25
2043550	35,5	N.4	339	190	1	€ 100.05
2043600	36	N.4	344	195	1	€ 105.98
2043650	36,5	N.4	344	195	1	€ 109.87
2043700	37	N.4	344	195	1	€ 111.97
2043750	37,5	N.4	344	195	1	€ 113.72
2043800	38	N.4	349	200	1	€ 117.22
2043850	38,5	N.4	349	200	1	€ 119.65
2043900	39	N.4	349	200	1	€ 122.03
2043950	39,5	N.4	349	200	1	€ 124.77

SAP	Ø mm	Cone Morse	L1 mm	L2 mm	fl	PREÇO
2044000	40	N.4	349	200	1	€ 126.32
2044050	40,5	N.4	354	205	1	€ 133.57
2044100	41	N.4	354	205	1	€ 133.77
2044150	41,5	N.4	354	205	1	€ 136.32
2044200	42	N.4	354	205	1	€ 138.78
2044250	42,5	N.4	354	205	1	€ 148.28
2044300	43	N.4	359	210	1	€ 153.22
2044350	43,5	N.4	359	210	1	€ 156.88
2044400	44	N.4	359	210	1	€ 158.72
2044450	44,5	N.4	359	210	1	€ 161.95
2044500	45	N.4	359	210	1	€ 164.27
2044550	45,5	N.4	364	215	1	€ 172.17
2044600	46	N.4	364	215	1	€ 177.45
2044650	46,5	N.4	364	215	1	€ 180.42
2044700	47	N.4	364	215	1	€ 182.93
2044750	47,5	N.4	364	215	1	€ 191.80
2044800	48	N.4	369	220	1	€ 206.42
2044850	48,5	N.4	369	220	1	€ 220.38
2044900	49	N.4	369	220	1	€ 230.23
2044950	49,5	N.4	369	220	1	€ 234.85
2045000	50	N.4	369	220	1	€ 237.08
2045050	50,5	N.4	374	225	1	€ 243.28
2055100	51	N.5	412	225	1	€ 299.22
2055150	51,5	N.5	412	225	1	€ 299.22
2055200	52	N.5	412	225	1	€ 299.27
2055250	52,5	N.5	412	225	1	€ 299.28
2055300	53	N.5	412	225	1	€ 299.28
2055350	53,5	N.5	417	230	1	€ 323.63
2055400	54	N.5	417	230	1	€ 323.63
2055450	54,5	N.5	417	230	1	€ 329.23
2055500	55	N.5	417	230	1	€ 329.23
2055550	55,5	N.5	417	230	1	€ 368.53
2055600	56	N.5	417	230	1	€ 378.33
2055650	56,5	N.5	422	235	1	€ 379.52
2055700	57	N.5	422	235	1	€ 379.52
2055750	57,5	N.5	422	235	1	€ 452.77
2055800	58	N.5	422	235	1	€ 452.77
2055850	58,5	N.5	422	235	1	€ 554.22
2055900	59	N.5	422	235	1	€ 554.23
2055950	59,5	N.5	422	235	1	€ 554.25
2056000	60	N.5	422	235	1	€ 554.25
2056100	61	N.5	427	240	1	€ 554.35
2056200	62	N.5	427	240	1	€ 555.30
2056300	63	N.5	427	240	1	€ 619.18
2056400	64	N.5	432	245	1	€ 591.58
2056500	65	N.5	432	245	1	€ 591.58
2056600	66	N.5	432	245	1	€ 591.58
2056700	67	N.5	432	245	1	€ 667.27
2056800	68	N.5	437	250	1	€ 686.63
2056900	69	N.5	437	250	1	€ 686.75
2057000	70	N.5	437	250	1	€ 686.43
2057100	71	N.5	437	250	1	€ 729.07
2057200	72	N.5	442	255	1	€ 894.27
2057300	73	N.5	442	255	1	€ 894.27
2057400	74	N.5	442	255	1	€ 894.42
2057500	75	N.5	442	255	1	€ 894.42
2057600	76	N.5	447	260	1	€ 894.48

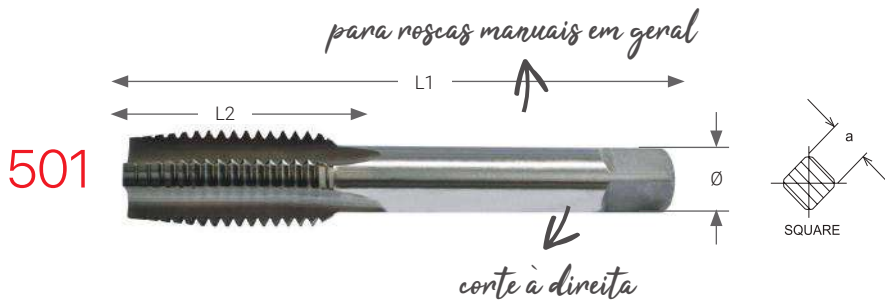

MACHOS DE ABRIR ROSCAS MANUAIS - 501

SAP	Tamanho	Passo	Ø mm	L1 mm	L2 mm	a	Nº ranhuras	fl	PREÇO
5010220	M2.2	0.45	2.8	44.5	9.5	2.24	3	1	€ 101.38
5010250	M2.5	0.45	2.8	44.5	9.5	2.24	3	1	€ 101.38
5010300	M3	0.5	3.15	48	11	2.5	3	1	€ 19.07
5010350	M3.5	0.6	3.55	50	13	2.8	3	1	€ 21.02
5010400	M4	0.7	4	53	13	3.15	3	1	€ 15.77
5010450	M4.5	0.75	4.5	53	13	3.55	3	1	€ 27.10
5010500	M5	0.8	5	58	16	4	3	1	€ 16.03
5010600	M6	1	6.3	66	19	5	3	1	€ 17.42
5010700	M7	1	7.1	66	19	5.6	4	1	€ 24.03
5010800	M8	1.25	8	72	22	6.3	4	1	€ 20.18
5010900	M9	1.25	9	72	22	7.1	4	1	€ 35.08
5011000	M10	1.5	10	80	24	8	4	1	€ 27.37
5011100	M11	1.5	8	85	25	6.3	4	1	€ 42.58
5011200	M12	1.75	9	89	29	7.1	4	1	€ 40.27
5011400	M14	2	11.2	95	30	9	4	1	€ 50.88

SAP	Tamanho	Passo	Ø mm	L1 mm	L2 mm	a	Nº ranhuras	fl	PREÇO
5011600	M16	2	12.5	102	32	10	4	1	55.62 €
5011800	M18	2.5	14	112	37	11.2	4	1	68.88 €
5012000	M20	2.5	14	112	37	11.2	4	1	78.52 €
5012200	M22	2.5	16	118	38	12.5	4	1	96.52 €
5012400	M24	3	18	130	45	14	4	1	110.33 €
5012700	M27	3	20	135	45	16	4	1	171.73 €
5013000	M30	3.5	20	138	48	16	4	1	203.25 €
5013300	M33	3.5	22.4	151	51	18	4	1	261.10 €
5013600	M36	4	25	162	57	20	4	1	289.53 €
5013900	M39	4	28	170	60	22.4	6	1	402.42 €
5014200	M42	4.5	28	170	60	22.4	6	1	446.38 €
5014500	M45	4.5	31.5	187	67	25	6	1	489.77 €
5014800	M48	5	31.5	187	67	25	6	1	589.33 €
5015200	M52	5	35.5	200	70	28	6	1	791.77 €
5015600	M56	5.5	35.5	200	70	28	6	1	1124.77 €



MACHOS DE MÁQUINA ABRIR ROSCAS À DIREITA - 508

SAP	Tamanho	Passo	Ø mm	L1 mm	L2 mm	a	Nº ranhuras	fl	PREÇO
5080200	M2	0.4	2.5	41	8	2	3	1	€ 27.78
5080300	M3	0.5	3.15	48	11	2.5	3	1	€ 13.82
5080350	M3.5	0.6	3.55	50	13	2.8	3	1	€ 22.33
5080400	M4	0.7	4	53	13	3.15	3	1	€ 8.88
5080500	M5	0.8	5	58	16	4	3	1	€ 9.43
5080600	M6	1	6.3	66	19	5	3	1	€ 10.08
5080700	M7	1	7.1	66	19	5.6	3	1	€ 14.22
5080800	M8	1.25	8	72	22	6.3	3	1	€ 15.30
5080900	M9	1.25	9	72	22	7.1	3	1	€ 16.42
5081000	M10	1.5	10	80	24	8	3	1	€ 18.37
5081100	M11	1.5	8	85	25	6.3	3	1	€ 12.08

SAP	Tamanho	Passo	Ø mm	L1 mm	L2 mm	a	Nº ranhuras	fl	PREÇO
5081200	M12	1.75	9	89	29	7.1	3	1	€ 22.02
5081400	M14	2	11.2	95	30	9	3	1	€ 30.93
5081600	M16	2	12.5	102	32	10	4	1	€ 36.78
5081800	M18	2.5	14	112	37	11.2	4	1	€ 50.88
5082000	M20	2.5	14	112	37	11.2	4	1	€ 53.90
5082200	M22	2.5	16	118	38	12.5	4	1	€ 61.93
5082400	M24	3	18	130	45	14	4	1	€ 68.68
5082700	M27	3	20	135	45	16	4	1	€ 95.22
5083000	M30	3.5	20	138	48	16	4	1	€ 106.95
5083300	M33	3.5	22.4	151	51	18	4	1	€ 137.27
5083600	M36	4	25	162	57	20	4	1	€ 154.92



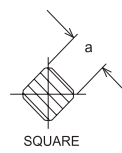
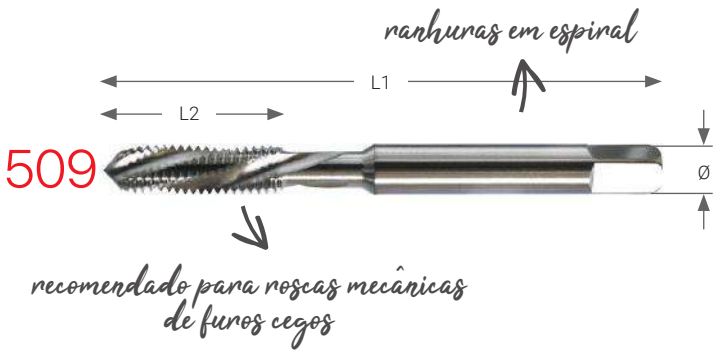

HSSE V3	ISO 529	M		ISO 2 6H
		RANHURAS ESPIRAL		

MACHOS DE MÁQUINA ABRIR ROSCAS ESPIRAL - 509

SAP	Tamanho	Passo	Ø mm	L1 mm	L2 mm	a	Nº ranhuras	Ø	PREÇO
5090300	M3	0.5	3.15	48	11	2.5	3	1	€ 10.65
5090350	M3.5	0.6	3.55	50	13	2.8	3	1	€ 9.52
5090400	M4	0.7	4	53	13	3.15	3	1	€ 10.42
5090500	M5	0.8	5	58	16	4	3	1	€ 11.28
5090600	M6	1	6.3	66	19	5	3	1	€ 12.65
5090700	M7	1	7.1	66	19	5.6	3	1	€ 20.77
5090800	M8	1.25	8	72	22	6.3	3	1	€ 14.57
5090900	M9	1.25	9	72	22	7.1	3	1	€ 16.32
5091000	M10	1.5	10	80	24	8	3	1	€ 16.98

SAP	Tamanho	Passo	Ø mm	L1 mm	L2 mm	a	Nº ranhuras	Ø	PREÇO
5091100	M11	1.5	8	85	25	6.3	3	1	€ 20.12
5091200	M12	1.75	9	89	29	7.1	3	1	€ 20.93
5091400	M14	2	11.2	95	30	9	3	1	€ 28.48
5091600	M16	2	12.5	102	32	10	3	1	€ 32.23
5091800	M18	2.5	14	112	37	11.2	4	1	€ 44.12
5092000	M20	2.5	14	112	37	11.2	4	1	€ 46.95
5092200	M22	2.5	16	118	38	12.5	4	1	€ 55.85
5092400	M24	3	18	130	45	14	4	1	€ 71.85

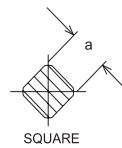

HSSE V3	ISO 529	M		ISO 2 6H
		RANHURAS ESPIRAL		

MACHOS DE MÁQUINA ABRIR ROSCAS ESPIRAL - 510

SAP	Tamanho	Passo	Ø mm	L1 mm	L2 mm	a	Nº ranhuras	Ø	PREÇO
5100600	M6	1	6.3	66	19	5	3	1	€ 12.65
5100700	M7	1	7.1	66	19	5.6	3	1	€ 13.72
5100800	M8	1.25	8.0	72	22	6.3	3	1	€ 14.57
5101000	M10	1.5	10.0	80	24	8	3	1	€ 17.17
5101200	M12	1.75	9.0	89	29	7.1	3	1	€ 20.93
5101400	M14	2	11.2	95	30	9	3	1	€ 28.48

SAP	Tamanho	Passo	Ø mm	L1 mm	L2 mm	a	Nº ranhuras	Ø	PREÇO
5101600	M16	2	12.5	102	32	10	3	1	€ 36.38
5101800	M18	2.5	14.0	112	37	11.2	4	1	€ 46.47
5102000	M20	2.5	14.0	112	37	11.2	4	1	€ 48.98
5102200	M22	2.5	16.0	118	38	12.5	4	1	€ 55.42
5102400	M24	3	18.0	130	45	14	4	1	€ 69.58

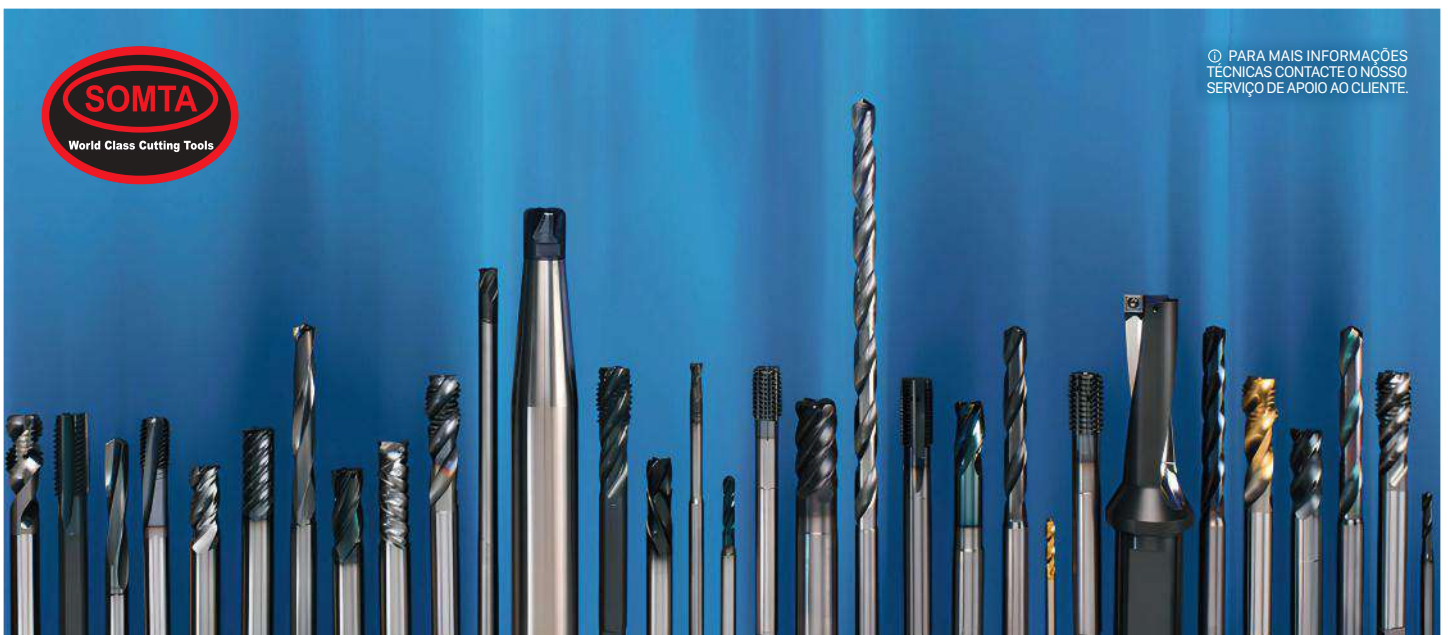

© PARA MAIS INFORMAÇÕES TÉCNICAS CONTACTE O NOSSO SERVIÇO DE APOIO AO CLIENTE.

511

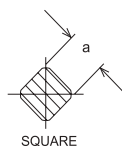
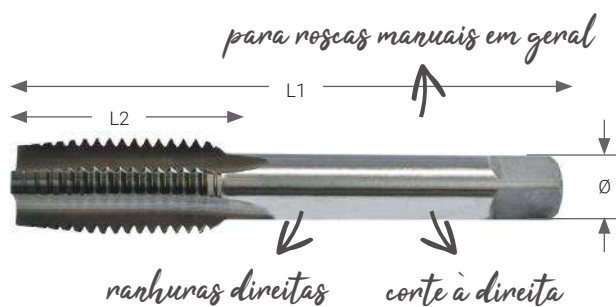

HSSE V3	ISO 529		MF	
ISO 2 6H			BANHURAS DIREITAS	

MACHOS DE ABRIR ROSCAS MANUAIS CURTOS MÉTRICA FINA - 511

SAP	Tamanho	Passo	Ø mm	L1 mm	L2 mm	a	Nº ranhuras	ñ	PREÇO
5110300	MF3	0.35	3.15	48	11	2.5	3	1	€ 42.58
5110400	MF4	0.5	4	53	13	3.15	3	1	€ 39.60
5110500	MF5	0.5	5	58	16	4	3	1	€ 21.18
5110510	MF5	0.75	5	58	16	4	3	1	€ 21.18
5110550	MF5.5	0.5	5.6	62	17	4.5	3	1	€ 21.18
5110600	MF6	0.75	6.3	66	19	5	3	1	€ 17.48
5110700	MF7	0.75	7.1	66	19	5.6	4	1	€ 23.77
5110790	MF8	0.75	8	69	19	6.3	4	1	€ 18.83
5110800	MF8	1	8	69	19	6.3	4	1	€ 18.83
5110890	MF9	0.75	9	69	19	7.1	4	1	€ 30.93
5110990	MF10	0.75	10	76	20	8	4	1	€ 22.72
5111000	MF10#	1	10	76	20	8	4	1	€ 19.92
5111010	MF10	1.25	10	76	20	8	4	1	€ 19.92
5111110	MF11	1	8	82	22	6.3	4	1	€ 23.72
5111120	MF11	1.25	8	82	22	6.3	4	1	€ 20.55
5111190	MF12	1	9	84	24	7.1	4	1	€ 24.83
5111200	MF12*	1.25	9	84	84	7.1	4	1	€ 27.47
5111210	MF12	1.5	9	89	89	7.1	4	1	€ 27.47
5111390	MF14	1	11.2	90	25	9	4	1	€ 40.57
5111400	MF14*	1.25	11.2	90	25	9	4	1	€ 33.93
5111410	MF14	1.5	11.2	95	30	9	4	1	€ 33.93
5111490	MF15	1	11.2	95	30	9	4	1	€ 68.02
5111500	MF15	1.5	11.2	95	30	9	4	1	€ 68.02
5111590	MF16	1	12.5	95	25	10	4	1	€ 38.52
5111600	MF16#	1.5	12.5	102	32	10	4	1	€ 38.52
5111700	MF17	1.5	12.5	102	32	10	4	1	€ 61.57
5111780	MF18	1	14	104	29	11.2	4	1	€ 45.90

* Encaixe Spark | # Canal

SAP	Tamanho	Passo	Ø mm	L1 mm	L2 mm	a	Nº ranhuras	ñ	PREÇO
5111790	MF18	1.25	14	104	29	11.2	4	1	€ 55.33
5111800	MF18*	1.5	14	104	29	11.2	4	1	€ 45.90
5111810	MF18	2	14	112	37	11.2	4	1	€ 55.12
5111990	MF20	1	14	104	29	11.2	4	1	€ 52.35
5112000	MF20#	1.5	14	104	29	11.2	4	1	€ 52.35
5112010	MF20	2	14	112	37	11.2	4	1	€ 63.10
5112190	MF22	1	16	113	33	12.5	4	1	€ 64.37
5112200	MF22	1.5	16	113	33	12.5	4	1	€ 64.37
5112210	MF22	2	16	118	38	12.5	4	1	€ 81.15
5112390	MF24	1	18	120	35	14	4	1	€ 116.42
5112400	MF24	1.5	18	120	35	14	4	1	€ 84.42
5112410	MF24	2	18	120	35	14	4	1	€ 84.42
5112490	MF25	1	18	120	35	14	4	1	€ 89.68
5112500	#MF25	1.5	18	120	35	14	4	1	€ 89.68
5112510	MF25	2	18	120	35	14	4	1	€ 143.43
5112700	MF27	1.5	20	127	37	16	4	1	€ 137.33
5112710	MF27	2	20	127	37	16	4	1	€ 114.52
5112800	MF28	1.5	20	127	37	16	4	1	€ 135.52
5112820	MF28	2	20	127	37	16	4	1	€ 126.97
5113000	MF30	1.5	20	127	37	16	4	1	€ 159.30
5113010	MF30	2	20	127	37	16	4	1	€ 159.30
5113020	MF30	3	20	138	48	16	4	1	€ 190.97
5113210	MF32	2	22.4	137	37	18	4	1	€ 192.83
5113310	MF33	2	22.4	137	37	18	4	1	€ 174.08
5113620	MF36	3	25	162	57	20	4	1	€ 222.87
5114200	MF42	1.5	28	149	39	22.4	6	1	€ 356.93
5114210	MF42	2	28	149	39	22.4	6	1	€ 356.93

571

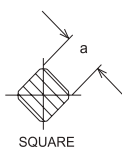
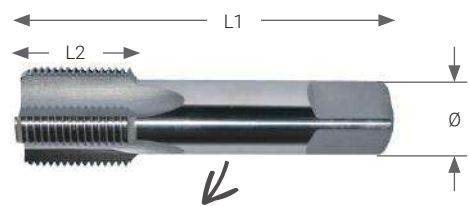

HSS	ISO 2284		BSP	
BS 949 1982			BANHURAS DIREITAS	

MACHOS DE ABRIR ROSCAS MANUAIS CURTOS - 571

SAP	Tamanho	Ø mm	L1 mm	L2 mm	a	Nº ranhuras	ñ	PREÇO
5710320	1/8	8	59	15	6.3	4	1	€ 27.37
5710640	1/4	10	67	19	8	4	1	€ 33.63
5710950	3/8	12.5	75	21	10	4	1	€ 61.93
5711270	1/2	16	87	26	12.5	4	1	€ 79.05
5711590	5/8	18	91	26	14	4	1	€ 120.48
5711910	3/4	20	96	28	16	4	1	€ 131.77

SAP	Tamanho	Ø mm	L1 mm	L2 mm	a	Nº ranhuras	ñ	PREÇO
5712220	7/8	22.4	102	29	18	4	1	€ 168.57
5712540	1"	25	109	33	20	6	1	€ 199.68
5713170	1 1/4	31.5	119	36	25	6	1	€ 326.82
5713810	1 1/2	35.5	125	37	28	6	1	€ 430.35
5714450	1 3/4	35.5	132	39	28	6	1	€ 557.57
5715080	2"	40	140	41	31.5	6	1	€ 693.23





575

perfeito para roscas manuais em orifícios cónicos, passantes ou cegos



MACHOS DE ABRIR ROSCAS MANUAIS CURTOS - 575

SAP	Tamanho	Ø mm	L1 mm	L2 mm	L3 mm	a	Nº ranhuras	Ø	PREÇO
5750320	1/8	8	59	15	10.1	6.3	5	1	€ 24.72
5750640	1/4	10	67	19	15	8	5	1	€ 35.93
5750641	1/4	10	67	19	15	8	5	1	€ 17.98
5750950	3/8	12.5	75	21	15.4	10	5	1	€ 48.48
5751270	1/2	16	87	26	20.5	12.5	5	1	€ 71.72

SAP	Tamanho	Ø mm	L1 mm	L2 mm	L3 mm	a	Nº ranhuras	Ø	PREÇO
5751910	3/4	20	96	28	21.8	16	5	1	€ 96.03
5752540	1"	25	109	33	26	20	5	1	€ 132.57
5753170	1.1/4	31.5	119	36	28.3	25	7	1	€ 194.88
5753810	1.1/2	35.5	125	37	28.3	28	7	1	€ 238.73

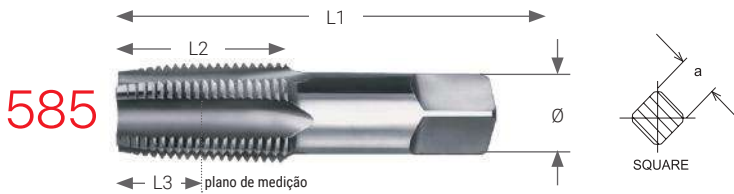

585

ranhuras direitas



MACHOS DE ABRIR ROSCAS MANUAIS CURTOS - 585

SAP	Tamanho	Ø mm	L1 mm	L2 mm	L3 mm	a	Nº ranhuras	Ø	PREÇO
5850320	1/8	8	59	15	7.9	6.3	3	1	€ 26.73
5850640	1/4	10	67	19	11.7	8	5	1	€ 41.13
5850950	3/8	12.5	75	21	11.5	10	5	1	€ 48.48
5851270	1/2	16	87	26	14.7	12.5	5	1	€ 71.72

SAP	Tamanho	Ø mm	L1 mm	L2 mm	L3 mm	a	Nº ranhuras	Ø	PREÇO
5851910	3/4	20	96	28	14.4	16	5	1	€ 107.63
5852540	1"	25	109	33	17.2	20	5	1	€ 136.23
5853170	1.1/4	31.5	119	36	17.4	25	7	1	€ 200.07
5853810	1.1/2	35.5	125	37	17.8	28	7	1	€ 245.03

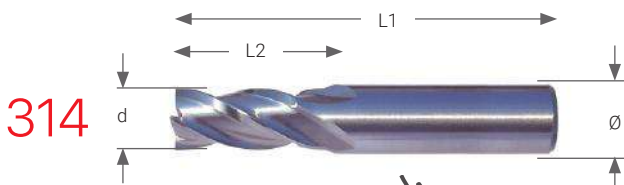

314

recomendado para fresagem de perfis



FRESA TOPO 4L DIN 844 - 314

SAP	Ø mm	d mm	L1 mm	L2 mm	Ø	PREÇO
3140300	6	3	52	8	1	€ 10.17
3140400	6	4	55	11	1	€ 10.27
3140500	6	5	57	13	1	€ 10.32
3140600	6	6	57	13	1	€ 9.88
3140700	10	7	66	16	1	€ 13.68
3140800	10	8	69	19	1	€ 14.02
3140900	10	9	69	19	1	€ 14.07
3141000	10	10	72	22	1	€ 14.62
3141100	12	11	79	22	1	€ 20.02
3141200	12	12	83	26	1	€ 20.75

SAP	Ø mm	d mm	L1 mm	L2 mm	Ø	PREÇO
3141300	12	13	83	26	1	€ 22.73
3141400	12	14	83	26	1	€ 26.90
3141500	12	15	83	26	1	€ 29.92
3141600	16	16	92	32	1	€ 32.52
3141800	16	18	92	32	1	€ 36.80
3141900	16	19	92	32	1	€ 37.65
3142000	20	20	104	38	1	€ 44.83
3142200	20	22	104	38	1	€ 53.48
3142500	25	25	121	45	1	€ 68.18



HSS ISO 5421 W H 13

BURIL QUADRADO HSS - 601

SAP	L	d	∅	PREÇO
6010025	63	4	1	€ 2.70
6010034	63	5	1	€ 2.93
6010050	63	6	1	€ 1.97
6010060	80	6	1	€ 2.53
6010070	100	6	1	€ 3.12
6010085	200	6	1	€ 6.25
6010090	63	8	1	€ 3.17
6010100	80	8	1	€ 4.03
6010110	100	8	1	€ 5.03
6010120	160	8	1	€ 8.08
6010122	200	8	1	€ 10.07
6010125	63	10	1	€ 4.62
6010130	80	10	1	€ 5.87
6010140	100	10	1	€ 7.32

SAP	L	d	∅	PREÇO
6010150	160	10	1	€ 11.75
6010152	200	10	1	€ 14.68
6010155	63	12	1	€ 6.02
6010160	80	12	1	€ 8.15
6010170	100	12	1	€ 10.22
6010191	160	12	1	€ 16.30
6010192	200	12	1	€ 20.42
6010200	100	16	1	€ 17.17
6010220	160	16	1	€ 27.48
6010222	200	16	1	€ 34.38
6010225	150	18	1	€ 63.98
6010256	160	20	1	€ 41.42
6010267	200	20	1	€ 51.83
6010290	200	25	1	€ 79.02



HSS ISO 5421 h8 (d)

BURIL REDONDO HSS - 605

SAP	L	d	∅	PREÇO
6050030	80	4	1	€ 1.00
6050032	100	4	1	€ 1.37
6050035	63	5	1	€ 2.27
6050036	80	5	1	€ 3.12
6050037	100	5	1	€ 4.97
6050060	80	6	1	€ 1.08
6050070	100	6	1	€ 1.70
6050080	160	6	1	€ 2.52
6050085	200	6	1	€ 3.97
6050090	63	8	1	€ 5.52
6050100	80	8	1	€ 0.98
6050110	100	8	1	€ 1.43
6050123	160	8	1	€ 1.83
6050125	200	8	1	€ 3.02

SAP	L	d	∅	PREÇO
6050128	63	10	1	€ 4.40
6050140	100	10	1	€ 10.78
6050150	160	10	1	€ 3.18
6050155	200	10	1	€ 4.40
6050158	63	12	1	€ 6.40
6050160	80	12	1	€ 9.27
6050170	100	12	1	€ 16.22
6050182	160	12	1	€ 23.13
6050200	100	16	1	€ 5.73
6050220	160	16	1	€ 13.83
6050225	200	16	1	€ 11.22
6050255	160	20	1	€ 18.50
6050258	200	20	1	€ 30.12
6050290	200	25	1	€ 43.43



*aço de alta velocidade com
8% de Cobalto*

621

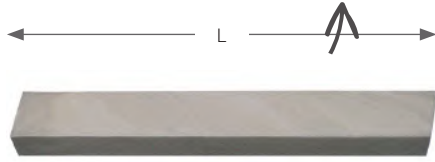

*com chanfro de 10°
em ambos os extremos*

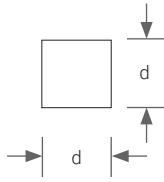

**HSS
CO8** **ISO
5421** **W
H 13**

BURIL QUADRADO HSSCO - 621

SAP	L	d	∅	PREÇO
6210027	80	4	1	€ 2.82
6210030	80	5	1	€ 2.17
6210060	100	6	1	€ 5.05
6210070	200	6	1	€ 6.72
6210085	200	6	1	€ 13.28
6210085	200	6	1	€ 13.28
6210100	80	8	1	€ 8.10
6210110	100	8	1	€ 10.75
6210120	160	8	1	€ 17.08
6210122	200	8	1	€ 21.32
6210125	63	10	1	€ 10.07
6210140	100	10	1	€ 15.78
6210150	160	10	1	€ 25.03

SAP	L	d	∅	PREÇO
6210152	200	10	1	€ 31.27
6210158	63	12	1	€ 7.30
6210160	80	12	1	€ 17.43
6210170	100	12	1	€ 21.75
6210180	160	12	1	€ 34.48
6210195	200	12	1	€ 43.03
6210200	100	16	1	€ 36.47
6210220	160	16	1	€ 57.97
6210224	200	16	1	€ 72.28
6210230	160	18	1	€ 35.37
6210258	160	20	1	€ 87.48
6210290	200	20	1	€ 109.12
6210300	200	25	1	€ 165.75

625

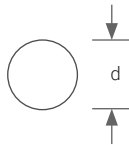

*para aços de corte livre, aços estruturais,
ligas de aço endurecidas*

**HSS
CO8** **ISO
5421** **W
H 13** \varnothing h8 (d)

BURIL REDONDO HSSCO - 625

SAP	L	d	∅	PREÇO
6250032	100	4	1	€ 8.47
6250034	63	5	1	€ 2.28
6250036	80	5	1	€ 2.85
6250038	100	5	1	€ 8.47
6250040	63	6	1	€ 1.47
6250060	80	6	1	€ 3.92
6250070	100	6	1	€ 10.13
6250080	160	6	1	€ 3.77
6250085	200	6	1	€ 20.33
6250090	63	8	1	€ 4.73
6250100	80	8	1	€ 2.82
6250110	100	8	1	€ 19.22
6250120	160	8	1	€ 30.75
6250122	200	8	1	€ 38.43

SAP	L	d	∅	PREÇO
6250129	63	10	1	€ 7.12
6250130	80	10	1	€ 3.92
6250140	100	10	1	€ 24.03
6250145	160	10	1	€ 38.43
6250150	200	10	1	€ 48.02
6250155	63	12	1	€ 9.27
6250160	80	12	1	€ 6.12
6250170	100	12	1	€ 28.80
6250192	200	12	1	€ 57.62
6250200	100	16	1	€ 24.80
6250240	160	16	1	€ 59.42
6250250	200	16	1	€ 48.80
6250253	200	20	1	€ 122.62
6250255	200	25	1	€ 198.58

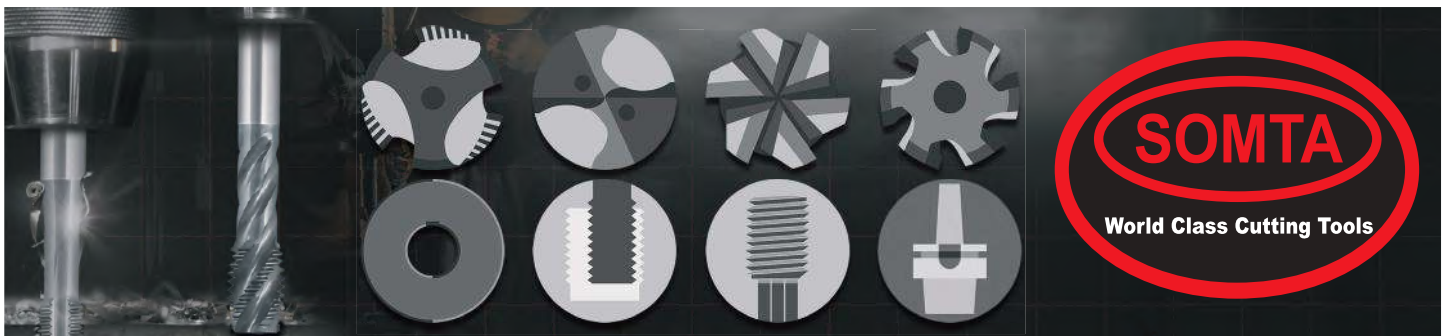

Serras e lâminas de corte



1.

Speed slot para uma remoção mais rápida e fácil.

1. SERRAS CRANEANAS BIMETÁLICAS T3. Ø14 -152 mm.

LNXT30009-9L 9L / Ø 14 mm	€ 15.26
LNXT30010-10L 10L / Ø16 mm	€ 12.20
LNXT30011-11L 11L / Ø17 mm	€ 12.20
LNXT30012-12L 12L / Ø19 mm	€ 12.20
LNXT30098-20MMHS / Ø20 mm	€ 12.20
LNXT30013-13L 13L / Ø21 mm	€ 12.20
LNXT30014-14L 14L / Ø22 mm	€ 12.20
LNXT30015-15L 15L / Ø24 mm	€ 12.20
LNXT30016-16L 16L / Ø25 mm	€ 12.96
LNXT30017-17L 17L / Ø27 mm	€ 12.96
LNXT30018-18L 18L / Ø29 mm	€ 12.96
LNXT30019-19L 19L / Ø30 mm	€ 12.96
LNXT30020-20L 20L / Ø32 mm	€ 12.96
LNXT30021-21L 21L / Ø33 mm	€ 12.96
LNXT30022-22L 22L / Ø35 mm	€ 13.69
LNXT30023-23L 23L / Ø37 mm	€ 13.69
LNXT30024-24L 24L / Ø38 mm	€ 13.69
LNXT30025-25L 25L / Ø40 mm	€ 13.69
LNXT30026-26L 26L / Ø41 mm	€ 13.69
LNXT30027-27L 27L / Ø43 mm	€ 13.69
LNXT30028-28L 28L / Ø44 mm	€ 17.19
LNXT30029-29L 29L / Ø46 mm	€ 17.19
LNXT30030-30L 30L / Ø48 mm	€ 17.19

LNXT30032-32L 32L / Ø51 mm	€ 17.19
LNXT30033-33L 33L / Ø52 mm	€ 21.16
LNXT30034-34L 34L / Ø54 mm	€ 21.16
LNXT1816241 35L / Ø56 mm	€ 21.16
LNXT30036-36L 36L / Ø57 mm	€ 21.16
LNXT30038-38L 38L / Ø60 mm	€ 21.16
LNXT1816242 39L / Ø62 mm	€ 22.81
LNXT30040-40L 40L / Ø64 mm	€ 22.81
LNXT30041-41L 41L / Ø65 mm	€ 22.81
LNXT30042-42L 42L / Ø67 mm	€ 22.81
LNXT30043-43L 43L / Ø68 mm	€ 22.81
LNXT30044-44L 44L / Ø70 mm	€ 22.81
LNXT30046-46L 46L / Ø73 mm	€ 22.81
LNXT30048-48L 48L / Ø76 mm	€ 23.54
LNXT30050-50L 50L / Ø79 mm	€ 23.81
LNXT30052-52L 52L / Ø83 mm	€ 23.81
LNXT30054-54L 54L / Ø86 mm	€ 23.81
LNXT30056-56L 56L / Ø89 mm	€ 23.81
LNXT30058-58L 58L / Ø92 mm	€ 27.46
LNXT30060-60L 60L / Ø95 mm	€ 32.44
LNXT30062-62L 62L / Ø98 mm	€ 34.06
LNXT30064-64L 64L / Ø102 mm	€ 35.69
LNXT30066-66L 66L / Ø105 mm	€ 38.73
LNXT30068-68L 68L / Ø108 mm	€ 50.74
LNXT30070-70L 70L / Ø111 mm	€ 60.39
LNXT30072-72L 72L / Ø114 mm	€ 70.01
LNXT30074-74L 74L / Ø117 mm	€ 73.94
LNXT30076-76L 76L / Ø121 mm	€ 77.87
LNXT30080-80L 80L / Ø127 mm	€ 86.46
LNXT1816243 83L / Ø133 mm	€ 91.59
LNXT30088-88L 88L / Ø140 mm	€ 103.40
LNXT30096-96L 96L / Ø152 mm	€ 120.81
3106106L 106L / Ø168 mm	€ 129.07
LNXT3112112L 112L / Ø177 mm	€ 136.01
3132132L 132L / Ø210 mm	€ 165.37



2.

Aço carbono endurecido para maior resistência

2. ÁRVORES/ SUPORTES SERRAS CRANEANAS Standard. Ø14 - 210 mm.

LNX1779774 ACC 1L / Ø14-30 mm	€ 16.70
LNX1779801 ACC 2L / Ø32-210 mm	€ 28.24
LNX1779802 ACC 3L / Ø 32-210 mm	€ 28.64
LNX1779803 ACC 4L / Ø 14-30 mm	€ 11.64
LNX1779804 ACC 5L / Ø 14-30 mm	€ 17.10
LNX1779805 ACC 6L / Ø 30-210 mm	€ 26.04
LNX1779806 ACC 7L / Ø 38-210 mm	€ 49.31
LNXT30015-15L Broca Piloto ACC 4321	€ 5.71



3.

3. FOLHA DE SERRA MANUAL 300 mm. 24 dentes. Bi-Metal. 100 un.

LNXT20117-224HE 12x1/2x24.	€ 1.41/un
-------------------------------	-----------



4.

4. LÂMINA SRB 25 un.

LNXT20493-B610R 610R 150 mm 10Z.	€ 65.71
LNXT20590-B810R 810R 200 mm 10Z	€ 77.14
LNXT20491-B110R 110R 300 mm 10Z	€ 157.14
LNXT20529-B618R 618R 150 mm 18Z	€ 68.57
LNXT20487-B818R 818R 200 mm 18Z	€ 85.71



© PARA MAIS INFORMAÇÕES TÉCNICAS CONTACTE O NOSSO SERVIÇO DE APOIO AO CLIENTE.

**EBEC030
BERBEQUIM BASE MAGNÉTICA**

900 W. 775 rpm. Peso 8.5 kg.
Força magnética 1200 kg. 275x190x383 mm. Fuso 19.05 mm Weldon.



Ø12-30mm
brocas
craneanas



Ø1-13mm
brocas
helicoidais



Ø12-35mm
escareadores



- ▶ Soluções premium e inovadoras de perfuração e corte, adaptadas aos mais diversos setores.
- ▶ Indicador LED de desgaste da escova.
- ▶ Proteção contra picos de corrente e flutuações de potência.



€ **648.⁵⁵**

EBECOTUBE-30

BERBEQUIM BASE MAGNÉTICA P/ APLICAÇÃO EM TUBOS

900 W. 900 rpm. Peso 11 kg.
Força magnética 532 kg. 275x185x416mm. Fuso 19.05 mm Weldon.



Ø12-30mm
brocas
craneanas



Ø1-13mm
brocas
helicoidais



Ø12-35mm
escareadores



EBEC030S+

BERBEQUIM BASE MAGNÉTICA

900 W. 775 Rpm. Peso 8.5 Kg.
Força magnética 1200 Kg. 275x190x383 mm. Fuso 19.05 mm Weldon.



Ø12-30mm
brocas
craneanas



Ø1-13mm
brocas
helicoidais



Ø12-35mm
escareadores



€ **1181.⁶⁹**



€ **817.³⁵**

EBECO36
BERBEQUIM BASE MAGNÉTICA DE BAIXO PERFIL

1050 W. 700 rpm. Peso 10.3 kg.
Força magnética 1200 kg. 310x135x165 mm. Fuso 19.05 mm Weldon.

- 
 Ø12-36mm
brocas
craneanas
- 
 Ø1-14mm
brocas
helicoidais
- 
 Ø10-40mm
escareadores



€1203.¹⁶

EBECO40S+/IC
BERBEQUIM BASE MAGNÉTICA

1150 W. 600 rpm. Peso 11.2 kg.
Força magnética 1500 kg. 264x180x440 mm. Fuso 19.05 mm Weldon.

- 
 Ø12-40mm
brocas
craneanas
- 
 Ø1-16mm
brocas
helicoidais
- 
 Ø10-45mm
escareadores



€782.³³

EBEBM36/P-18V
BERBEQUIM BASE MAGNÉTICA C/ BATERIA E CARREGADOR

1000 W. 18V / 9.0 Ah Li-ion. 530 rpm. Peso 10.2 kg.
Força magnética 650 kg. 325x235x410 mm. Fuso 19.05 mm Weldon.

- 
 Ø12-36mm
brocas
craneanas
- 
 Ø1-13mm
brocas
helicoidais
- 
 Ø10-40mm
escareadores

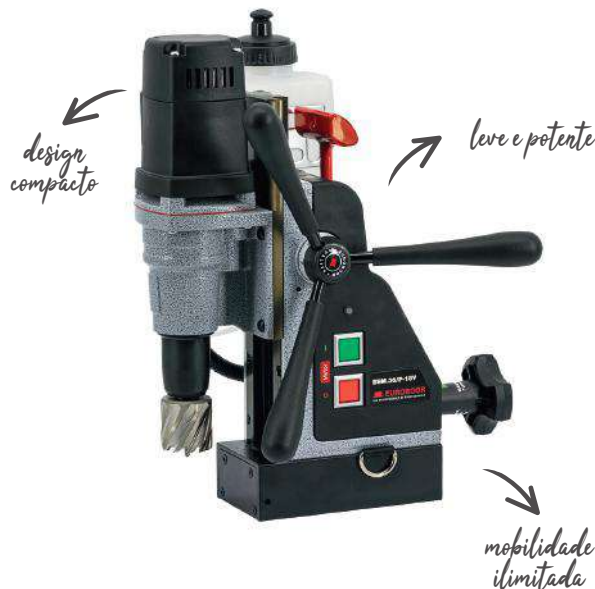

€1427.⁵⁵

EBECO50-S
BERBEQUIM BASE MAGNÉTICA

1250 W. 2 velocidades - 690 rpm. Peso 12 kg.
Força magnética 1700 kg. 320x200x615 mm. Fuso MT3 19.05 mm Weldon.

- 
 Ø12-50mm
brocas
craneanas
- 
 Ø1-23mm
brocas
helicoidais
- 
 Ø10-55mm
escareadores



€1181.¹⁶

EBECO50+/T
BERBEQUIM BASE MAGNÉTICA

1250 W. 2 velocidades - 530 rpm. Capacidade roscagem M3-M20. Peso. 13.5 kg. Força magnética 1850 kg. 320x210x540 mm. Fuso MT2 19.05 mm Weldon.



Ø12-50mm
brocas
craneanas



Ø1-23mm
brocas
helicoidais



Ø10-55mm
escareadores



€1446.²⁷

EBECO200S/T
BERBEQUIM BASE MAGNÉTICA

2600 W. 4 velocidades - 470 rpm. Capacidade roscagem M3-M48. Peso. 58.5 kg. Força magnética 3680 kg. 515x265x905 mm. Fuso MT4 31.75 mm Weldon.



Ø12-200mm
brocas
craneanas



Ø1-50mm
brocas
helicoidais



Ø10-205mm
escareadores



€4107.⁸⁸

EBECO100S+/T
BERBEQUIM BASE MAGNÉTICA

1900 W. 4 velocidades - 620 rpm. Capacidade roscagem M3-M30. Peso. 27.8 kg. Força magnética 3000 kg. 365x310x710 mm. Fuso MT3 19.05 mm Weldon.



Ø12-100mm
brocas
craneanas



Ø1-31.75mm
brocas
helicoidais



Ø10-105mm
escareadores



€2191.⁸⁴

EBHCLKIT/10-1
JOGO 10 BROCAS CRANEANAS HSS

19.05 mm Weldon (55 mm)
Ø 12/14/16/18/20/22/24/26/28/30mm.
2 pernos de centrar incluídos.



€141.⁴³

EBHCSKIT/10-1
JOGO 10 BROCAS CRANEANAS HSS

19.05 mm Weldon (30 mm)
Ø 12/14/16/18/20/22/24/26/28/30mm.
2 pernos de centrar incluídos.



€141.⁴³

EBHCSKIT
JOGO 6 BROCAS CRANEANAS HSS

19.05 mm Weldon. 1 Broca Piloto IBC.70+
2xØ14mm + 2xØ18mm + 2xØ22mm



€75.³¹

EBTDS100
JOGO 19 BROCAS HELICOIDAIS HSS-CO

Ø 1-10 mm. Din 338. 135°.



€30.⁹²

Ferramentas para madeira e metal

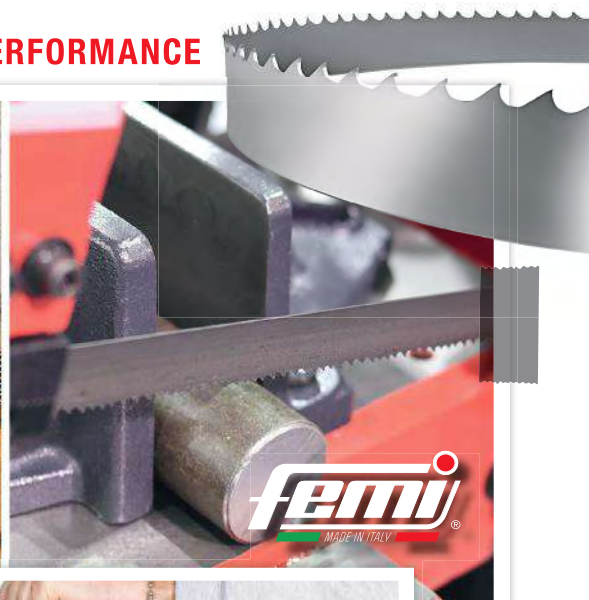

F780XL SERRA DE FITA PORTÁTIL 850W

Fita de serra 1335x13x0,65 mm.
Capacidade de corte 0° a 45°.
Velocidade: 60-80 mt/min. 17 Kg.

↔ Máx 105mm



€ 530.³⁶

- ▶ Fabricado em Itália.
- ▶ Produtos seguros e fiáveis para trabalho diário em oficina.
- ▶ Alto desempenho e fiabilidade.
- ▶ Produtos de uso industrial e doméstico.



F782XL SERRA DE FITA PORTÁTIL 950W

Fita de serra 1335x13x0,65 mm. Capacidade de corte 0° a 45°.
Velocidade: 60-80 mt/min. 16 Kg.

↔ Máx 105mm



€ 660.⁰⁰

F784XL SERRA DE FITA PORTÁTIL 1200W

Fita de serra 1440x13x0,65 mm. Capacidade de corte 0° a 45°.
Velocidade: 30-80 mt/min. 17 Kg.

↔ Máx 120mm



€ 978.²¹

F787XL SERRA DE FITA PORTÁTIL 1850W

Fita de serra 2140x19x0,9 mm. Capacidade de corte 0° a 45°.
Velocidade: 30-80 mt/min. 59 Kg.

↔ Máx 213mm



€ 1885.⁷¹

F785XL SERRA DE FITA PORTÁTIL 2000W

Fita de serra 1735x19x0,9 mm. Capacidade de corte 0° a 45°.
Velocidade: 35-80 mt/min. 75 Kg.

↔ Máx 205mm



€ 1558.⁰⁷

indicada para uso industrial



**FLEXICUT1140E
SERRA DE FITA PORTÁTIL 950W**

Fita de serra: 1140x13x0,65 mm. Capacidade de corte 0° a 45°.
Velocidade: 30-80 mt/min. 17 kg.

← Máx 130x120mm



€ 294.⁶⁴

**FLEXIBASE340
BASE PARA SERRA DE FITA**

Indicado para FLEXICUT1140E.



com tornos integrado

€ 96.⁶⁴



**FDCSNG110
SERRA DE FITA PORTÁTIL 950W**

Fita de serra: 1335x13x0,65 mm. Capacidade de corte 0° a 45°.
Velocidade: 30-80 mt/min. 17 kg.

← Máx 110mm



€ 952.⁵⁰

**FNG120XL
SERRA DE FITA PORTÁTIL 1200W**

Fita de serra: 1440x13x0,65 mm. Capacidade de corte 0/45/60°.
Velocidade: 30-80 mt/min. 18 kg.

← Máx 120mm



€ 1162.⁵⁰

**FNG160
SERRA DE FITA PORTÁTIL 2000W**

Fita de serra: 1735x13x0,9 mm. Capacidade de corte 0° a 45°.
Velocidade: 30-80 mt/min. 35 kg.

← Máx 160mm

← corte até 40% mais rápido



€ 1838.⁵⁷

**F733
SERRA DE ESQUADRIA PARA MADEIRA**

1300 W. 2850 rpm. ØDisco 254 mm.
Capacidade de corte 0° a 45°. 17,5 Kg.

← Máx 162mm

→ permite corte composto de 45° + 45° mm



€ 424.²⁹

**FF733 (F733+F300PLUS)
CONJUNTO SERROTE DE DISCO + BASE REGULÁVEL JOBBY**

1300 W. 2850 rpm. ØDisco 254 mm.
Capacidade de corte 0° a 45°. 17,5 Kg.

← Máx 162mm



+



Dimensões: 650x420x740/820/870 mm.
Dobrável para fácil manuseio.
Estrutura de secção de aço resistente.
Altura ajustável em três posições.
Carga máxima de 50 Kg.
Sistema de bloqueio de segurança.

€ 454.⁸⁶

**F1750XL
SERRA DE FITA 2000W**

Fita de serra: 2140x19x0,9 mm. Capacidade de corte 0° a 45°. Velocidade: 35-80 mt/min. 75 kg.

← Máx 160mm



**FABS1750XL
SERRA DE FITA 2000W**

Fita de serra 1735x19x0,9 mm. Capacidade de corte 0° a 45°. Velocidade: 35-80 mt/min. 75 Kg.

← Máx 160mm



**F2200XL
SERRA DE FITA 2000W**

Fita de serra: 2140x19x0,9 mm. Capacidade de corte 0/45/60°. Velocidade: 35-80 mt/min. 140 kg.

← Máx 200mm



€ **2153.¹⁷**

€ **2153.¹⁷**

€ **2526.⁸⁶**

**F2200DAXL
SERRA DE FITA 2000W**

Fita de serra: 2140x19x0,9 mm. Capacidade de corte 0/45/60°. Velocidade: 35-80 mt/min. 143 kg.

← Máx 200mm



€ **2906.³⁶**

**FN250DAXL
SERRA DE FITA 1100W**

Fita de serra: 2480x27x0,9 mm. Capacidade de corte 0/45/60°. Velocidade: 70 mt/min. 200 kg.

← Máx 250mm



€ **2998.²⁹**

FN251DAXL
SERRA DE FITA 750/1100W

Fita de serra: 2480x27x0,9 mm. Capacidade de corte 0/45/60°.
Velocidade: 45-90 mt/min. 200 kg.

↔ Máx 250mm



€ **2998.²⁹**

FN257DADG
SERRA DE FITA 750/1100W

Fita de serra: 2480x27x0,9 mm. Capacidade de corte 0/45/60°.
Velocidade: 45-90 mt/min. 235 kg.

↔ Máx 245x148mm - 253x70mm



€ **4424.³⁶**

FN276DAXL
SERRA DE FITA 750/1100W

Fita de serra: 2565x27x0,9 mm. Capacidade de corte 0/45/60°.
Velocidade: 35-70 mt/min. 311 kg.

↔ Máx 265x200mm



€ **4083.⁷⁶**

FN310DADG
SERRA DE FITA 1000/1500W

Fita de serra: 2750x27x0,9 mm. Capacidade de corte 0/45/60°.
Velocidade: 35-70 mt/min. 344 kg.

↔ Máx 320mm



€ **5902.²⁹**

FBG26N
ESMERILADORA 150W
Monofásico. 2950 rpm. 6 kg.
Roda de esmeril Ø150x16x12,7 mm.



€ 64.⁸³

FBG31N
ESMERILADORA 330W
Monofásico. 2950 rpm. 9 kg.
Roda de esmeril Ø150x20x12,7 mm.



€ 100.²⁰

FBG33N
ESMERILADORA 370W
Monofásico. 2950 rpm. 14 kg.
Roda de esmeril Ø200x20x16 mm.



€ 127.¹⁰

FBG36N
ESMERILADORA/POLIDORA 330W
Monofásico. 2950 rpm. 9 kg.
Roda de esmeril Ø150x20x12,7 mm.



€ 110.⁶¹

FBG46N
ESMERILADORA/LIXADORA 330W
Monofásico. 2950/140 rpm. 10 kg.
Roda de esmeril Ø150x20x12,7 mm/
Ø200X40X20 mm.



€ 117.⁶⁴

FBG56N
ESMERILADORA/LIXADORA 330W
Monofásico. 2950 rpm. 9 kg.
Roda de esmeril Ø150x20x12,7 mm.



€ 120.⁹³

F575
LIXADORA DE BANDA 3000W
Trifásico. 2800 rpm. 30mt/s. 79 kg.
Cinta de lixa 75x2000 mm.



€ 940.⁵⁰

F577
LIXADORA DE BANDA 4000W
Trifásico. 1400/2800 rpm. 2 velocidades. 15/30mt/s. 95 kg.
Cinta de lixa 150x2000 mm.



€ 1455.⁵⁴

FDP12-921
ENG. DE FURAR DE BANCADA 500W
Monofásico. 5 velocidades - 580-2650 rpm.
Altura 580 mm. Bancada de trabalho 160x160 mm.
Mandril 1,5-13mm. Curso do mandril 280 mm. 18 kg.



€ 161.⁴⁷

FDP12-941
ENG. DE FURAR DE BANCADA 460W
Monofásico. 12 velocidades - 230-2470 rpm.
Altura 845 mm. Bancada de trabalho 202x197 mm.
Mandril 3-16mm. Curso do mandril 60 mm. 27 kg.



€ 267.³⁰

FDIGIMAX13
ENG. DE FURAR DE BANCADA DIGITAL 720W
Monofásico. 12 velocidades - 220-2550 rpm.
Altura 660 mm. Bancada de trabalho 340x300 mm.
Mandril 13mm. Curso do mandril 280 mm. 9.5 kg.



€ 282.⁸⁶

FDP12-943

ENG. DE FURAR DE COLUNA 460W

Monofásico. 12 velocidades - 180-2740 rpm.
Altura 1610 mm. Bancada de trabalho 255x255 mm.
Mandril 16mm. Curso do mandril 80mm. 27 kg.



€ 438.⁴³

FDP12-961

ENG. DE FURAR DE BANCADA 1100W

Monofásico. 12 velocidades - 150-2020 rpm.
Altura 1700 mm. Bancada de trabalho 475x425 mm.
Mandril 3-20mm. Curso do mandril 120 mm. 116 kg.



€ 1058.³⁶

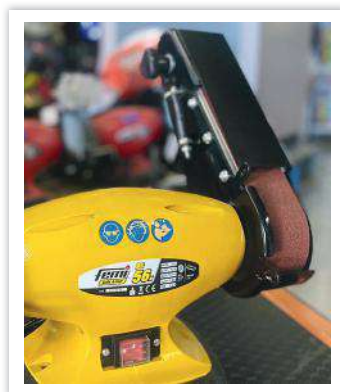

► Use sempre equipamentos de proteção individual, como óculos de proteção, luvas resistentes ao corte e, se necessário, protetores auriculares. Isso protegerá os seus olhos, mãos e audição dos perigos associados ao uso destes equipamentos.





Ar comprimido

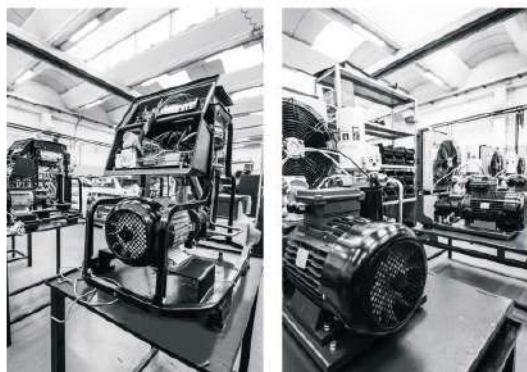

LA PADANA

AIR COMPRESSORS



- ▶ Facilidade de utilização e manutenção.
- ▶ Funcionamento silencioso.
- ▶ Máxima eficiência energética.
- ▶ Vasta gama de opções de 2.2kW a 132kW.
- ▶ **QUALITY MADE IN ITALY**



PS Series
MOD. PS 490/ PS615

2 cilindros
Fácil manutenção
Baixo nível sonoro

COMPRESSOR SEM ÓLEO

4-7.5 kW / 5.5-10 HP

SAP	MODELO	PRESSÃO	Nº CILINDROS	POTÊNCIA NOMINAL	CAUDAL	ALIMENTAÇÃO	NÍVEL RUÍDO	CAPACIDADE	PESO	PREÇO
PA80608	PS 490	8 Bar 116 Psi	2	2+2 HP 1.5+1.5 kW	520Lt/min 31.2m ³ m	230V 1PH 50hz	68dB (A)	90 Lt	72 kg	€1343.57
PA80611	PS 615	8 Bar 116 Psi	2	2+2+2 HP 1.5+1.5+1.5 kW	780Lt/min 46.8m ³ m	400V 3PH 50hz	52-62dB (A)	150 Lt	102 kg	€2095.71

© Para mais informações técnicas contacte o nosso serviço de apoio ao cliente.

SPRINT AIR

MOD. SAT-4/90



SPECIAL HIGH EFFICIENCY MOTOR



VERSÃO C/ RESERVATÓRIO

- Acionamento coaxial
- Motor elétrico diretamente ligado à unidade de parafuso: permite melhor rendimento
- Filtro separador de óleo SPIN-ON
- Filtro de óleo SPIN-ON
- Arrefecimento a óleo/ar através de radiador com ventilação eléctrica
- Funcionamento ON/OFF
- Arranque direto
- Cartão de controlo eletrónico
- As versões com reservatório de ar estão equipadas com uma válvula.

COMPRESSOR DE PARAFUSO ROTATIVO

2.2-3 kW / 3-4 HP

SAP	MODELO	PRESSÃO	POTÊNCIA NOMINAL	CAUDAL	ALIMENTAÇÃO	NÍVEL RUÍDO	CAPACIDADE	PESO	PREÇO
PA53120	SAT 3L/M 90L	9 Bar 130 Psi	3 HP 2.2 kW	300Lt/min 18m ³ h	230V 1PH 50hz	68dB(A)	90 Lt	80 kg	€3028.93
PA53121	SAT 3L/T 90L	9 Bar 130 Psi	3 HP 2.2 kW	300Lt/min 18m ³ h	400V 3PH 50hz	68dB (A)	90 Lt	80 kg	€3148.93
PA53140	SAT 4L/T 90L	10 Bar 143 Psi	4 HP 3 kW	400Lt/min 24m ³ h	400V 3PH 50hz	68dB (A)	90 Lt	82 kg	€3148.93

Ⓞ Para mais informações técnicas contacte o nosso serviço de apoio ao cliente.

SPRINT AIR

MOD. SAT 3-4/200



VERSÃO C/ RESERVATÓRIO

- Acionamento coaxial
- Motor elétrico diretamente ligado à unidade de parafuso: permite melhor rendimento
- Filtro separador de óleo SPIN-ON
- Filtro de óleo SPIN-ON
- Arrefecimento a óleo/ar através de radiador com ventilação eléctrica
- Funcionamento ON/OFF
- Arranque direto
- Cartão de controlo eletrónico
- As versões com reservatório de ar estão equipadas com uma válvula e uma linha de ligação ao depósito.

COMPRESSOR DE PARAFUSO ROTATIVO

2.2-3 kW / 3-4 HP

SAP	MODELO	PRESSÃO	POTÊNCIA NOMINAL	CAUDAL	ALIMENTAÇÃO	NÍVEL RUÍDO	CAPACIDADE	PESO	PREÇO
PA53220	SAT 3L/M 200L	9 Bar 130 Psi	3 HP 2.2 kW	300Lt/min 18m ³ h	230V 1PH 50hz	68dB(A)	200 Lt	80 kg	€3028.93
PA53221	SAT 3L/T 200L	9 Bar 130 Psi	3 HP 2.2 kW	300Lt/min 18m ³ h	400V 3PH 50hz	68dB(A)	200 Lt	80 kg	€3148.93
PA53240	SAT 4L/T 200L	10 Bar 143 Psi	4 HP 3 kW	400Lt/min 24m ³ h	400V 3PH 50hz	68dB(A)	200 Lt	82 kg	€3148.93

Ⓞ Para mais informações técnicas contacte o nosso serviço de apoio ao cliente.

SPRINT AIR

MOD. SAT3-4/200 E



VERSÃO C/ RESERVATÓRIO E SECADOR

- Acionamento coaxial
- Motor elétrico diretamente ligado à unidade de parafuso: permite melhor rendimento
- Filtro separador de óleo SPIN-ON
- Filtro de óleo SPIN-ON
- Arrefecimento a óleo/ar através de radiador com ventilação forçada
- Funcionamento ON/OFF
- Arranque direto
- Cartão de controlo eletrónico
- As versões com reservatório de ar estão equipadas com uma válvula e uma linha de ligação ao depósito.

COMPRESSOR DE PARAFUSO ROTATIVO

2.2-3 kW / 3-4 HP

SAP	MODELO	PRESSÃO	POTÊNCIA NOMINAL	CAUDAL	ALIMENTAÇÃO	NÍVEL RUÍDO	CAPACIDADE	SECADOR	PESO	PREÇO
PA53320	SAT 3L/M 200 E	9 Bar 130 Psi	3 HP 2.2 kW	300Lt/min 18m ³ h	230V 1PH 50hz	68dB (A)	200 Lt	LPE 4	150 kg	€4080.00
PA53321	SAT 3L/T 200 E	9 Bar 130 Psi	3 HP 2.2 kW	300Lt/min 18m ³ h	230V 1PH 50hz	68dB (A)	200 Lt	LPE 4	150 kg	€4175.36
PA53340	SAT 4L/T 200 E	10 Bar 143 Psi	4 HP 3 kW	400Lt/min 24m ³ h	400V 3PH 50hz	68dB (A)	200 Lt	LPE 4	150 kg	€4176.79

Ⓞ Para mais informações técnicas contacte o nosso serviço de apoio ao cliente.

SPRINT AIR

MOD. SAT 7-10



SPECIAL HIGH EFFICIENCY MOTOR



- Acionamento coaxial.
- Motor elétrico diretamente ligado à unidade de parafuso: permite melhor rendimento.
- Filtro separador de óleo SPIN-ON.
- Filtro de óleo SPIN-ON.
- Arrefecimento a óleo/ar através de radiador com ventilação eléctrica.
- Carga de funcionamento e carga com paragem temporizada.
- Arranque estrela-triângulo.
- Cartão de controlo eletrónico.
- As versões com reservatório de ar estão equipadas com uma válvula e linha de ligação do depósito.

COMPRESSOR DE PARAFUSO COAXIAL

4-7.5 kW / 5.5-10 HP

SAP	MODELO	PRESSÃO	POTÊNCIA NOMINAL	CAUDAL	ALIMENTAÇÃO	NÍVEL RUÍDO	CAPACIDADE	PESO	PREÇO
PA50033	SAT7	10 Bar 143 Psi	7.5 HP 5.5 kW	750Lt/min 45m ^{3h}	400V 3PH 50hz	70dB(A)	-	122 kg	€3825.00
PA50035	SAT10	10 Bar 143 Psi	10 HP 7.5 kW	1000Lt/min 60m ^{3h}	400V 3PH 50hz	70dB(A)	-	124 kg	€3922.50

Ⓞ Para mais informações técnicas contacte o nosso serviço de apoio ao cliente.

SPRINT AIR

MOD. SAT 5-7-10



VERSÃO C/ RESERVATÓRIO

- Acionamento coaxial.
- Motor elétrico diretamente ligado à unidade de parafuso: permite melhor rendimento.
- Filtro separador de óleo SPIN-ON.
- Filtro de óleo SPIN-ON.
- Arrefecimento a óleo/ar através de radiador com ventilação eléctrica.
- Carga de funcionamento e carga com paragem temporizada.
- Arranque estrela – triângulo.
- Cartão de controlo eletrónico.
- As versões com reservatório de ar estão equipadas com uma válvula e linha de ligação do depósito.

COMPRESSOR DE PARAFUSO COAXIAL

4-7.5 kW / 5.5-10 HP

SAP	MODELO	PRESSÃO	POTÊNCIA NOMINAL	CAUDAL	ALIMENTAÇÃO	NÍVEL RUÍDO	CAPACIDADE	PESO	PREÇO
PA50037	SAT5-270	10 Bar 143 Psi	5.5 HP 4 kW	550Lt/min 33m ^{3h}	400V 3PH 50hz	70dB(A)	270 Lt	200 kg	€4422.86
PA50039	SAT7-270	10 Bar 143 Psi	7.5 HP 5.5 kW	750Lt/min 45m ^{3h}	400V 3PH 50hz	70dB(A)	270 Lt	202 kg	€4522.50
PA50041	SAT10-270	11 Bar 157 Psi	10 HP 7.5 kW	1000Lt/min 60m ^{3h}	400V 3PH 50hz	70dB(A)	270 Lt	204 kg	€4600.71

Ⓞ Para mais informações técnicas contacte o nosso serviço de apoio ao cliente.

SPRINT AIR

MOD. SAT 5-7-10 E



VERSÃO C/ RESERVATÓRIO E SECADOR

- Acionamento coaxial.
- Motor elétrico diretamente ligado à unidade de parafuso: permite melhor rendimento.
- Filtro separador de óleo SPIN-ON.
- Filtro de óleo SPIN-ON.
- Arrefecimento a óleo/ar através de radiador com ventilação eléctrica.
- Carga de funcionamento e carga com paragem temporizada.
- Arranque estrela – triângulo.
- Cartão de controlo eletrónico.
- As versões com reservatório de ar estão equipadas com uma válvula e linha de ligação do depósito.

COMPRESSOR DE PARAFUSO ROTATIVO

2.2-3 kW / 3-4 HP

SAP	MODELO	PRESSÃO	POTÊNCIA NOMINAL	CAUDAL	ALIMENTAÇÃO	NÍVEL RUÍDO	CAPACIDADE	SECADOR	PESO	PREÇO
PA50043	SAT5 -270E	10 Bar 143 Psi	5.5 HP 4 kW	550Lt/min 33m ^{3h}	400V 3PH 50hz	70dB(A)	270 Lt	LPE 6	242 kg	€5561.79
PA50045	SAT7-270E	10 Bar 143 Psi	7.5 HP 5.5 kW	750Lt/min 45m ^{3h}	400V 3PH 50hz	70dB(A)	270 Lt	LPE 9	244 kg	€5638.93
PA50047	SAT10-270E	11 Bar 157 Psi	10 HP 7.5 kW	1000Lt/min 60m ^{3h}	400V 3PH 50hz	70dB(A)	270 Lt	LPE 9/12	246 kg	€5752.50

Ⓞ Para mais informações técnicas contacte o nosso serviço de apoio ao cliente.

MAXT AIR

MOD. MXP 550-1500 270



VERSÃO C/ RESERVATÓRIO

- Acionamento coaxial.
- Motor elétrico diretamente ligado à unidade de parafuso: permite melhor rendimento.
- Filtro separador de óleo SPIN-ON.
- Filtro de óleo SPIN-ON.
- Arrefecimento a óleo/ar através de radiador com ventilação eléctrica.
- Carga de funcionamento e carga com paragem temporizada.
- Arranque estrela – triângulo.
- Cartão de controlo eletrónico.
- As versões com reservatório de ar estão equipadas com uma válvula e linha de ligação do depósito.

COMPRESSOR DE PARAFUSO COAXIAL

5.5 - 15 kW / 7.5 - 20 HP

SAP	MODELO	PRESSÃO	POTÊNCIA NOMINAL	CAUDAL	ALIMENTAÇÃO	NÍVEL RUÍDO	CAPACIDADE	PESO	PREÇO
PA35644	MXP1000-270	10 Bar 145 Psi	10 HP 7.5 kW	1000L/min 60m ³ h	400V 3PH 50hz	66dB (A)	270 Lt	290 kg	€5394.64
PA35646	MXP1500-270	10 Bar 143 Psi	15 HP 11 kW	1500L/min 90m ³ h	400V 3PH 50hz	66dB (A)	270 Lt	307 kg	€5994.64

⊙ Para mais informações técnicas contacte o nosso serviço de apoio ao cliente.

MAXT AIR

MOD. MXP 550-1500 270 E



VERSÃO C/ RESERVATÓRIO E SECADOR

- Acionamento coaxial.
- Motor elétrico diretamente ligado à unidade de parafuso: permite melhor rendimento.
- Filtro separador de óleo SPIN-ON.
- Filtro de óleo SPIN-ON.
- Arrefecimento a óleo/ar através de radiador com ventilação eléctrica.
- Carga de funcionamento e carga com paragem temporizada.
- Arranque estrela – triângulo.
- Cartão de controlo eletrónico.
- As versões com reservatório de ar estão equipadas com uma válvula e linha de ligação do depósito.

COMPRESSOR DE PARAFUSO COAXIAL

5.5 - 15 kW / 7.5 - 20 HP

SAP	MODELO	PRESSÃO	POTÊNCIA NOMINAL	CAUDAL	ALIMENTAÇÃO	NÍVEL RUÍDO	CAPACIDADE	PESO	PREÇO
PA35744	MXP 1000-270 E	10 Bar 145 Psi	10HP 7.5 kW	1000L/min 60m ³ h	400V 3PH 50hz	66dB(A)	270 Lt	320kg	€6491.43
PA35746	MXP 1500-270 E	10 Bar 145 Psi	15HP 11 kW	1500L/min 90m ³ h	400V 3PH 50hz	66dB(A)	270 Lt	337kg	€7148.57
PA35746.1	MXP1500-270E-DRIVEN	6-13Bar 85-189 Psi	15HP 11 kW	340-1650L/min 20-98m ³ h	400V 3PH 52hz	68dB(A)	270 Lt	339kg	€9166.07

⊙ Para mais informações técnicas contacte o nosso serviço de apoio ao cliente.

MAXT AIR

MOD. MXH 550-1500 270 E



VERSÃO C/ RESERVATÓRIO E SECADOR

- Acionamento coaxial.
- Motor elétrico diretamente ligado à unidade de parafuso: permite melhor rendimento.
- Filtro separador de óleo SPIN-ON.
- Filtro de óleo SPIN-ON.
- Arrefecimento a óleo/ar através de radiador com ventilação eléctrica.
- Carga de funcionamento e carga com paragem temporizada.
- Arranque estrela – triângulo.
- Cartão de controlo eletrónico.
- As versões com reservatório de ar estão equipadas com uma válvula e linha de ligação do depósito.

COMPRESSOR DE PARAFUSO COAXIAL

5.5 - 15 kW / 7.5 - 20 HP

SAP	MODELO	PRESSÃO	POTÊNCIA NOMINAL	CAUDAL	ALIMENTAÇÃO	NÍVEL RUÍDO	CAPACIDADE	PESO	PREÇO
PA35758	MXH 2000-270 E	10 Bar 145 Psi	20HP 15kW	2000L/min 120m ³	400V 3PH 50hz	66dB(A)	270 Lt	320 kg	€8207.14
PA35758.1	MXH 2000 - 270 E DRIVEN	6-13 Bar 85-189 Psi	20HP 15kW	340-2200L/min 20-132m ³	400V 3PH 52hz	68dB(A)	270 Lt	384 kg	€10902.86

⊙ Para mais informações técnicas contacte o nosso serviço de apoio ao cliente.

Acessórios

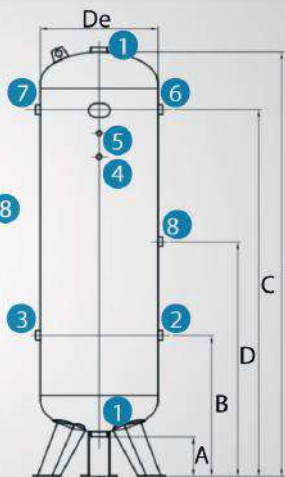
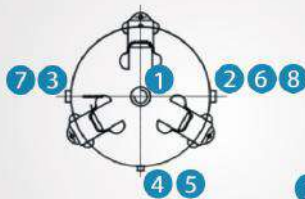

Tratamento superficial externo.
Galvanização a quente
Ral5015

RESERVATÓRIO VERTICAL

11-12-16 BAR

SAP	DIRETIVA	CAPACIDADE	PRESSÃO FUNCIONAMENTO	De	A	B	C	D	L	1	2	3	4	5	6	7	8	PESO	PREÇO
PA93010	2009/105/CE	270 Lt	11 Bar	500 mm	175 mm	599 mm	1304 mm	-	1648 mm	1/2"	1"	1"	-	3/8"	1"	-	-	67 kg	€605.00
PA93011	2009/105/CE	500 Lt	11 Bar	600 mm	155 mm	785 mm	1665 mm	-	2050 mm	2"	2"	2"	-	3/8"	2"	2"	-	116 kg	€878.00
PA93014	97/23/CE (PED)	1000 Lt	12 Bar	800 mm	145 mm	770 mm	1720 mm	-	2350 mm	2"	2"	2"	3/8"	3/8"	2"	2"	-	210 kg	€1502.00

Ⓞ Para mais informações técnicas contacte o nosso serviço de apoio ao cliente.



Elevada performance.
Os secadores AMD-LH são desenvolvidos para utilização com saídas de compressores standard.

SECADOR AMD-LH

11-12-16 BAR

SAP	MODELO	COMBINAÇÃO COMPRESSOR	CAUDAL	QUEDA DE PRESSÃO	LIGAÇÕES	ALIMENTAÇÃO	A	B	C	PESO	PREÇO
PA94407	AMD-LH 43	22kW-30HP	4300Lt/min 258m ³ h	0.24 Bar	G 1.1/4" BSP-F	230V 1PH 50hz	34 mm	44 mm	74 mm	40 kg	€2552.00
PA94408	AMD-LH 52	22kW-30HP	5200Lt/min 312m ³ h	0.34 Bar	G 1.1/4" BSP-F	230V 1PH 50hz	34 mm	44 mm	74 mm	41 kg	€2659.00
PA94409	AMD-LH 61	30kW-40HP	6100Lt/min 366m ³ h	0.19 Bar	G 1.1/2" BSP-F	230V 1PH 50hz	55 mm	58 mm	88 mm	54 kg	€3314.00
PA94410	AMD-LH 75	37kW-50HP	7500Lt/min 450m ³ h	0.25 Bar	G 1.1/2" BSP-F	230V 1PH 50hz	55 mm	58 mm	88 mm	56 kg	€3714.00

Ⓞ Para mais informações técnicas contacte o nosso serviço de apoio ao cliente.



INOVAÇÃO



TECNOLOGIA



DESIGN



GESTÃO



POUPANÇA ENERGÉTICA

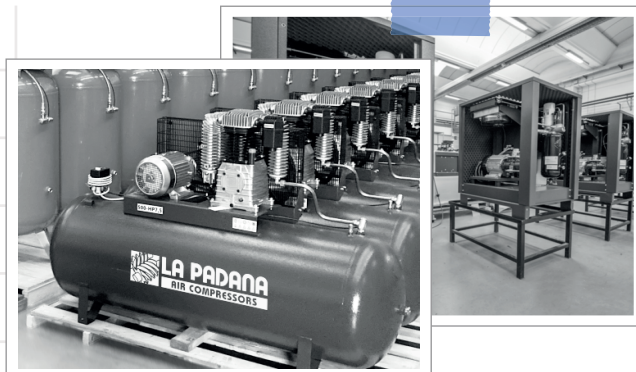

Acessórios para ar comprimido

MADE IN ITALY

© PARA MAIS INFORMAÇÕES TÉCNICAS CONTACTE O NOSSO SERVIÇO DE APOIO AO CLIENTE.

AH050126
SOPRADOR EM ALUMÍNIO
25/B1. 11/A. 163gr. Bocal em Zamak niquelado.



€ 7.¹²

AH050366
SOPRADOR EM ALUMÍNIO
25/B2. 11/A. 185gr. Cano em alumínio 180mm.



€ 8.⁸⁵

AH071310
PISTOLA DE LAVAGEM
26/E. 11/A. 287gr. Bico em latão niquelado com regulação do jato.



€ 17.³⁴

AH097741
PISTOLA APLICAÇÃO ESPUMA
A/218-ES. Adaptador Universal.



€ 19.⁶⁷

AH070802
PISTOLA DE LAVAGEM
26/F. Ø3.5mm. 556gr. Pressão máxima 20bar.



€ 55.¹⁶

AH060402
PISTOLA C/ MANÓMETRO
25/D-RB. 11/A. 400gr. Mangueira de PVC 400mm Ø6.5x12mm.



€ 28.⁰⁵

AH062249
PISTOLA C/ MANÓMETRO
PROFISSIONAL
25/GR 60. 11/A. 755gr. Mangueira de borracha 500mm Ø6x14mm.



€ 71.³⁶

AH081606
AEROGRÁFO DE PINTURA
F1-E-15 11/A. Ø1.5mm. 1000cc.



€ 50.⁷⁰

AH080407
AEROGRÁFO DE PINTURA
RV/15/I 11/A. Ø1.5mm. 1000 cc. Punho ergonómico em nylon.



€ 95.⁶⁶

AH0701001A
PISTOLA DE LAVAGEM
26/B. 11/A. 685gr. Tubo de entrega do produto metálico interior e exterior. Copo de alumínio.



€ 34.¹⁴

AH1507002A
AEROGRÁFO DE PINTURA
F1/N-SUPER/S. 11/A. 1/4M BSP. Bocal Ø1.5mm. 500 cc. Corpo em alumínio.



€ 100.⁷⁶

AH1509001A / AH1509002A
AEROGRÁFO DE PINTURA
F1N/S 12/15 11/A. Bocal Ø1.2/1.5 mm. 500 cc.



€ 50.⁹⁶

EXTRAORDINARY PASSION

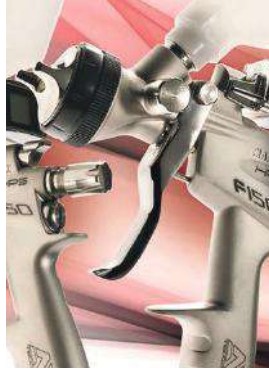

AH051358
KIT SOPRADOR C/ MANGUEIRA
AP/3-S. 15/A OMNI. 88gr. Mangueira 7,5mt.
Adaptador giratório Ø8x5mm 15/A OMNI.

AH092101
PISTOLA DE PINTURA
A/206 11/A. Bocal Ø5 mm. Tubo de
500mm 200gr. Corpo em alumínio.

AH091101
PISTOLA DE DECAPAGEM
A/209 11/A. Mangueira de borracha
1.20mt. Ø19/26 mm. 1078gr.

BH098016
AREIA SINTÉTICA
BOX/3. 700gr. Tamanho do grão: 0.25-
2.8mm.



€ 70.⁰⁶



€ 29.⁰⁴



€ 57.¹³



€ 35.⁴²

AH116102
FILTRO MODULAR
E/10/2. 1/4F BSP. 221gr. Capacidade
20cm³.

AH116202 / AH116801
LUBRIFICADOR MODULAR
E/11/2. 1/4F BSP. E/21/2. 3/8F BSP.

AH116702 / AH116507
FILTRO FRL
E/20/3. 1/2F BSP. E/12/2. 1/4F BSP.

AH117111 / AH117110
FILTRO FRL
E/22/3. 1/2F BSP. E/22/2. 3/8F BSP.



€ 24.²¹



AH116202
E/11/2. 1/4F BSP. 40cm³
€ 30.⁹⁸
AH116801
E/21/2. 3/8F BSP. 100cm³
€ 49.⁰⁹



AH116702
E/20/3. 1/2F BSP. 50 cm³
€ 42.³⁴
AH116507
E/12/2. 1/4F BSP
€ 75.⁸⁵



AH117111
E/22/3. 1/2F BSP
€ 117.⁴⁴
AH117110
E/22/2. 3/8F BSP
€ 119.⁰⁰

AH116302 / AH116902 / AH116901
REGULADOR MODULAR
E/14/2. 1/4F BSP. E/24/3. 1/2F BSP. E/24/2.
3/8F BSP.

AH116702 / AH101701
REGULADOR DE PRESSÃO
31/S4. 1/4 F BSP. 31/S4 1/4F. 1/4 F BSP.

AH102002 / AH102001
REGULADOR DE PRESSÃO
31/A4 1/4F. 1/4 F BSP. 31/A4 AIR11. 1/4 F
BSP.

BH108235 / BH108179
PRESSOSTATO COM COMUTADOR
Monofásico PR/01. 1/4F. Monofásico/
Trifásico PR/03. 1/4F.



AH116302
E/14/2. 1/4F BSP. 20cm³
€ 42.⁷⁸
AH116902
E/24/3. 1/2F BSP. 50cm³
€ 63.⁹⁷
AH116901
E/24/2. 3/8F BSP. 50cm³
€ 70.⁶⁶



AH101702
31/S4. 1/4 F BSP
€ 15.²³
AH101701
31/S4 1/4F. 1/4 F BSP
€ 18.⁸⁴



AH102002
31/A4 1/4F. 1/4 F BSP
€ 20.⁸⁴
AH102001
31/A4 AIR11. 1/4 F BSP
€ 25.⁸³



BH108235
Monofásico PR/01. 1/4F
€ 30.³⁵
BH108179
Monofásico/Trifásico PR/03. 1/4F
€ 46.²⁵



LORCH
smart welding

MADE IN GERMANY



© PARA MAIS INFORMAÇÕES
TÉCNICAS CONTACTE O NOSSO
SERVIÇO DE APOIO AO CLIENTE.



3 YEARS
INDUSTRIAL
WARRANTY
LORCH



LR55311000
MÁSCARA SOLDADURA APR 900
Máscara standard. True colour vision. Área de visão 98x62 mm.
Nível de proteção 3/5-9/10-14. Classe ótica 1/1/1. Ciclo de vida da bateria 4000h.
650 gr.



€ **356.²⁵**

KLR10801860
APARELHO DE SOLDAR HANDYTIG 180 CONTROL PRO
Monofásico. Faixa soldadura 3-180A. IP23S. 6.5 Kg.
Inclui: Tocha, Debitómetro e Cabo de Massa.



LR11116000
APARELHO DE SOLDAR MICORSTICK 160 BASIC PLUS
Monofásico. Faixa soldadura 10-150A. IP23S. 4.9 kg.
Inclui: Cabo de Massa e Porta-Eletrodos.



€ **793.⁷⁵**



€ **3275.⁰⁰**

LR21802510
APARELHO DE SOLDAR M-PRO 250 MIG CONTROL PRO
 Trifásico. Faixa soldadura 30-250A. IP23S. 71 Kg.
 Inclui: Tocha, Debitómetro e Cabo de Massa.



€ **2347.⁵⁰**

LR22630030
APARELHO DE SOLDAR R 300 CONTROL PRO -SET 25/4
 Trifásico. Faixa soldadura 20-290A. IP23S.
 Inclui: Tocha, Debitómetro e Cabo de Massa.



€ **3543.⁷⁵**

LR22435500
APARELHO DE SOLDAR MICOR MIG 350 BASIC PLUS
 Trifásico. Faixa soldadura 25-350A. IP23S. Eléctrodos Ø0.6 - 1.2mm. 58 kg.
 Inclui: Tocha, Debitómetro e Cabo de Massa.



€ **4837.⁵⁰**

LR22440581-MIC-M14
APARELHO DE SOLDAR MICOR MIG 400 BASIC PLUS
 Trifásico. Faixa soldadura 30-400A. IP23S.
 Eléctrodos Ø0.6 - 1.6mm. 61 Kg.
 Inclui: Tocha, Debitómetro e Cabo de Massa.



€ **8362.⁵⁰**

Soldadura e Consumíveis



Todos os produtos Solter possuem 2 anos de garantia.

E se se registar em www.solter.com no prazo de 30 dias a contar da data da compra, oferecemos-lhe 1 ano de garantia adicional.

Para transformadores, retifi cadores, circuitos eletrónicos e componentes defeituosos das linhas INVERTER MMA, TIG, MIG-MAG e carregadores de bateria. Consulte as condições em "Garantia Profissional 2+1" em www.solter.com/garantia.

► Fabricantes de equipamentos de soldadura de alta tecnologia.
► Indicados aos mais diversos tipos de utilizadores e setores.

- MMA
- TIG
- MIG/MAG
- PLASMA
- PROTEÇÃO
- ACESSÓRIOS
- BATERIA

Novo programa "SOLTER WELDING POINT".

A Solter aposta também nos pontos de venda, e ajuda a melhorar a presença e disponibilidade dos produtos. Entre em contacto com o seu agente e desenvolva o seu projeto SWP connosco!

AFIADOR DE TUNGSTÉNIOS TUNGSTEN SHARP 750

Ref. ST10350



O afiador de eletrodos de tungsténio portátil. Afiador para medidas de Ø1,6 mm a Ø4,0 mm incluído. Recipiente para a recolha de pó de tungsténio. Mala de transporte.

€ 460.00

CARACTERÍSTICAS TÉCNICAS

Tensão de alimentação	230V +/- 15%
Potência	750W
Eléctrodos admitidos	1,0 - 1,6 - 2,0 - 2,4 - 3,2 - 4,0
Ângulo de amolação	15º - 18º - 22,5º - 30º
Velocidade máxima	11000 rpm
Nº velocidades	6
Tamanho	340x76x76 mm
Peso	1,6 kg

PEÇAS



APARELHO DE LIMPEZA DE CORDÕES SOLDADURA SOLCLEAN STD

Ref. ST10366



Aparelho de limpeza / passivação de cordões de soldadura, em especial aços inox soldados mediante o procedimento TIG. Portátil e de fácil utilização, é fornecido com uma cómoda mala com todos os acessórios. A limpeza permite eliminar todos os efeitos de coloração e de oxidação do material.

- Tensão de alimentação U1 230V +/- 10%
- Tensão de trabalho Uo 12Vac
- Potência nominal 150VA
- Proteção térmica rearmável automaticamente
- Fusível substituível

€ 625.00

ACESSÓRIOS

- Ref. ST30579 **Porta-pincel SOLCLEAN** € 24.00
- Ref. ST30573 **Pincel grafite SOLCLEAN** € 14.00
- Ref. ST30578 **Líquido eletrolítico SOLCLEAN (1L)** € 35.00
- Ref. ST30577 **Frasco auxiliar SOLCLEAN 250ml** € 4.50
- Ref. ST30250 **Conjunto de massa 1,5 m Ø12 mm 200A** € 18.00

MMA

PRACTICO



PRACTICO 130

Ref. ST10100

130A | 2 kg | 100% MMA 20°C

€134.00



INCLUÍ:



1,5m Ø12 1,5m Ø12

Inverter Practico 130 + Acessórios + Mala + Máscara eletrônica Optimatic 45

Ref. STK0245



1,5m Ø12 1,5m Ø12

€144.00

PRACTICO 150

Ref. ST10093

150A | 2,1 kg | 100% MMA 20°C

€165.00



INCLUÍ:



1,5m Ø12 1,5m Ø12

Inverter Practico 150 + Acessórios + Mala + Máscara eletrônica Optimatic 45

Ref. STK0240



1,5m Ø12 1,5m Ø12

€175.00

CARACTERÍSTICAS TÉCNICAS

	50/60Hz	A	I ₂		X% normal % 20°C	EN60974-1			U _o V	Kg	mm	Elect./H				Kva	Technologies				
			MMA (A)	TIG (A)		% 40°C	I 60%	I 100%				2.0	2.5	3.2	4.0		TIG Lift	Hot Start	Arc Force	Digital	VRD
PRACTICO 130	230V-1ph	16A	10-130	10-130	100%	40%	90A	60A	62V	2	210x100x137	CONT.	CONT.	40		3,5	•	•	•	•	•
PRACTICO 150	230V-1ph	16A	10-150	10-150	100%	40%	100A	80A	62V	2.1	210x100x137	CONT.	CONT.	CONT.		4,5	•	•	•	•	•

ACESSÓRIOS



Ref. ST06024 **TIG SR-17V D10/25**
(Ø 1,6 mm)

€ 76.00



Ref. ST56246 **R25 AR/CO2**

€ 63.00

PROTECTOR INVERCONTROL DI 230

Ref. ST04119



Protege contra subidas e quedas de voltagem.

Ideal para conectar dispositivos de eletrônica sensível a fontes de corrente instáveis. Geradores, cabos de extensão, etc. Faixa de operação de 160V a 280V. Intensidade máxima 30Amp.

€112.75

CORE

CORE 160s

Ref. ST10217

€189.00



160A | 2,8 kg
60% MMA 20°C

INCLUÍ:



CORE 200Di

Ref. ST10207

€269.00



200A | 4,3 kg
60% MMA 20°C

INCLUÍ:



CORE 400i

Ref. ST10041

€1060.00



400A | 23 kg
60% MMA 20°C

INCLUÍ:



CORE 160s + Mala + Optimatic 55

Ref. STK0242

€199.00



CORE 200Di + Mala + Optimatic 100

Ref. STK0243

€289.00



CARACTERÍSTICAS TÉCNICAS

	50/60Hz	A	I ₂		X% normal % 20°C	EN60974-1		U _o V	Kg	mm	Elect./H					Kva	Technologies				
			MMA (A)	TIG (A)		% 40°C	I 60%				I 100%	2.0	2.5	3.2	4.0		5.0	TIG Lift	Hot Start	Arc Force	Digital
CORE 160s	230V-1ph	16A	20-160	20-160	60%	35%	130A	115A	50V	2,8	250x120x195	CONT.	CONT.	CONT.	10	4,5	•	•	•		
CORE 200Di	230V-1ph	32A	20-200	20-200	60%	40%	160A	135A	69V	4,3	320x120x195	CONT.	CONT.	CONT.	35	6,5	•	•	•	•	•
CORE 400i	400V-3ph	16A	15-400	15-400	60%	35%	306A	237A	82V	23	510x240x420	CONT.	CONT.	CONT.	CONT.	15	•	•	•	•	•

ACESSÓRIOS



Ref. ST06024 **TIG SR-17V D10/25** € 76.00
Core 160s (ø 1,6 mm)

Ref. ST06031 **TIG SR-17V D35/50** € 77.00
Core 200Di / 400i (ø 2,0mm)



Ref. ST56246 **R25 AR/CO2** € 63.00

MMA

DIRT

200A | 6 kg | 65% MMA 20°C
MMA CELULOSIC · ALUMINIUM WELDING



DIRT 200 CEL

Inverter de 200 A a 60%
Equipado com acessórios de soldadura
Válido para gerador
TIG Lift-Arc

Todos os tipos de elétrodos, incluindo de alumínio

Principais características

Os modelos DIRT são equipamentos *Inverter* de soldadura de elétrodos revestidos e TIG.

- Nova tecnologia *Arc-sense*, que permite soldar qualquer tipo de elétrodom, incluindo de alumínio.
- Facilidade de utilização graças à tecnologia *Inverter*, que proporciona corrente contínua DC.
- Mínimo consumo pela sua alta eficiência energética.
- Possibilidade de ligação a geradores com uma ampla gama de voltagens de utilização.
- Equipado com os dispositivos *Arc-Force* e *Hot-Start*.
- Possibilidade de soldadura TIG.
- Regulação digital.

Dirt 200 Cel + Mala + Helmet R-05



INCLUÍ:



€ **314.00**
Ref. ST10096

INCLUÍ:



€ **347.00**
Ref. STK0213



KIT SOLDADOR



€ **399.00**
Ref. STK0292

CARACTERÍSTICAS TÉCNICAS

	50/60Hz	A	I ₂		X% normal	EN60974-1		U _o	Kg	mm	Elect./H				Kva	Technologies					
			MMA (A)	TIG (A)		% 20°C	% 40°C				I 60%	I 100%	2.0	2.5		3.2	4.0	TIG Lift	Hot Start	Arc Force	Digital
DIRT 200	230V-1ph	32A	20-200	20-200	65%	40%	180A	150A	72V	6	370x166x280	CONT.	CONT.	CONT.	CONT.	6,5	•	•	•	•	•

ACESSÓRIOS



Ref. ST06031 **TIG SR-17V D35/50** € **77.00**
(ø 2,0 mm)



Ref. ST56246 **R25 AR/CO2** € **63.00**

STYL & ICON

STYL 205 PRO

Ref. ST04110

€ 555.00



200A | 7,5 kg | 70% MMA 20°C

INCLUÍ:



3m Ø25

2m Ø25

ICON 2055 PRO

Ref. ST04229

€ 635.00



200A | 6,4 kg | 80% MMA 20°C

INCLUÍ:



3m Ø25

2m Ø25



ICON 2055 PRO WI 4G

Ref. STK0237

€ 799.00



200A | 6,4 kg | 80% MMA 20°C

INCLUÍ:



3m Ø25

2m Ø25

Ref. STK0218

INCLUÍ:

€ 643.00



3m Ø25

2m Ø25

G GEOLOCALIZATION
 W WIFI 4G
 C CONNECT
 W WAAS

A primeira máquina com geolocalização

4G

* Serviço de geolocalização 4G incluído durante 1 ano. Após o primeiro ano, o serviço pode ser contratado em www.waaswelding.com

CARACTERÍSTICAS TÉCNICAS

	50/60Hz	A	I ₂		X% normal	EN60974-1		U _o	Kg	mm	Elect./H				Kva	Technologies				
			MMA (A)	TIG (A)		% 20°C	% 40°C				I 60%	I 100%	2.0	2.5		3.2	4.0	TIG Lift	Hot Start	Arc Force
STYL 205 PRO	230V-1ph	32A	10-200	10-220	70%	60%	200A 140A	80V	7,5	380x115x225	CONT.	CONT.	CONT.	CONT.	6,5	•	•	•	•	•
ICON 2055 PRO/WI	230V-1ph	32A	10-200	10-220	80%	60%	200A 140A	68V	6,4	430x175x325	CONT.	CONT.	CONT.	CONT.	6,6	•	•	•	•	•

ACESSÓRIOS



Ref. ST06031 **TIG SR-17V D35/50** € 77.00
(ø 2,0 mm)



Ref. ST56246 **R25 AR/CO2** € 63.00

TIG

ICONTIG



ICONTIG 1880 HF

Ref. STK0013

€ 619.00



180A | 4,9 kg
70% MMA 20°C

INCLUÍ:



ICONTIG 1990 HF PULSE

Ref. STK0014

€ 789.00



180A | 4,9 kg
70% MMA 20°C

INCLUÍ:



ICONTIG 2220 HF PULSE

Ref. STK0016

€ 976.00



220A | 6,4 kg
80% MMA 20°C

INCLUÍ:



ICONTIG 2220 HF PULSE Wi

Ref. STK0238

€ 1300.00



220A | 6,5 kg
80% MMA 20°C

INCLUÍ:



+ Mala

Ref. STK0219

€ 674.00



+ Mala

Ref. STK0220

€ 844.00



+ Mala

Ref. STK0221

€ 1031.00



CARACTERÍSTICAS TÉCNICAS

	50/60Hz	A	I ₂		EN60974-1 TIG 40°C			EN60974-1 MMA 40°C			U _o	Kg	mm	Kva	Technologies			
			TIG (A)	MMA (A)	% I max.	I 60%	I 100%	% I max.	I 60%	I 100%					Pulsed -Arc	Tack	Digital	
ICONTIG 1880 HF	DC	230V-1ph	16A	10-180	10-160	45%	140A	110A	45%	130A	100A	80V	4.9	320x135x285	6,5			•
ICONTIG 1990 HF Pulse	DC	230V-1ph	16A	10-180	10-160	45%	140A	110A	45%	130A	100A	80V	4.9	320x135x285	6,5	999Hz	•	•
ICONTIG 2220 HF Pulse / Wi	DC	230V-1ph	25A	10-220	10-200	50%	180A	140A	50%	180A	120A	68V	6.5	430x175x325	8,5	999Hz	•	•

ACESSÓRIOS

Ref. ST06009

3m CU25mm 10/25 ELE.200A

ICONTIG 1880/1990

€ 37.00



Ref. ST06126

3m Cu25mm 35/50 ELE 200A

ICONTIG 2220

€ 42.00



Ref. ST56246

R25 AR/CO2

€ 63.00



Ref. ST70608

Conector

€ 17.75



Ref. ST06034

Pedal

€ 270.00



Ref. ST10253

Carro UTS 400

€ 315.00

TIG

AEROTIG



AEROTIG AC/DC Wi

AEROTIG PRO DC

AEROTIG PRO AC/DC Wi



200A | 230V 1 ph | PULSED

320A-400 A | 400V 3 ph | PULSED

350A | 400V 3 ph | PULSED

COMPLETO DESDE **€ 2049.00**

COMPLETO DESDE **€ 2280.00**

COMPLETO DESDE **€ 4990.00**

+ UNIFORME SOLTER DE OFERTA

+ UNIFORME SOLTER DE OFERTA

+ UNIFORME SOLTER DE OFERTA

CARACTERÍSTICAS TÉCNICAS

				I_2		EN60974-1 TIG 40°C			EN60974-1 MMA 40°C			U_o				Technologies				
				TIG (A)	MMA (A)	% I max.	I 60%	I 100%	% I max.	I 60%	I 100%					V	Kg	mm	Kva	Pulsed -Arc
AEROTIG AC/DC Wi	AC/DC	50/60Hz	A	25A	10-200A	10-200A	50%	170A	120A	42%	155A	100A	65	14/49	280x360x465 / 1020	9,5	500 Hz	•	•	•
AEROTIG PRO DC	DC	400V-3ph	16A	5-320A	5-320A	45%	280A	250A	45%	280A	250A	62	70	1020x800x390	15,3	2000 Hz	•	•	•	
AEROTIG PRO AC/DC Wi	AC/DC	400V-3ph	20A	10-350A	10-350A	40%	300A	265A	35%	270A	220A	70	75	1020x800x390	20	2000 Hz	•	•	•	



CONFIGURE O SEU EQUIPAMENTO!

- Versão
- Tochas
- Sirgas
- Rolos
- Manómetro
- Conjuntos de massa
- Acessórios

E muito mais!

UNIFORME SOLDADOR SOLTER DE OFERTA!

AVALIADO EM 119 €!!



MIG/MAG

AEROPROCESS

AEROPROCESS 2000

200A | 19 kg | 230 V 1 ph

Synergic
Multiprocess
MMA-TIG-MIG
GÁS/ NO GÁS



INCLUÍ:



fio **0,8 mm**

€ 1199.00

Ref. STK0106

INCLUÍ:



fio **1,0 mm**

€ 1242.00

Ref. STK0222

KIT MULTIPROCESSO 2000

INCLUÍ:



€ 1445.00

Ref. STK0249

AEROPROCESS TRIO



€ 1990.00

**Equipamento 3 em 1:
Concebido para
trabalhar com até 3
tochas / materiais de
forma simultânea.**

Principais características

- Programação individual de cada tocha, com o trabalho a realizar (material - gás - Ø fio - processo - ajustes).
- Ativação automática da tocha, apertando simplesmente o gatilho.
- Mostrador gráfico de 4,3", com ajuste sinérgico de Volt/Amp, visualização de espessura do material e amperagem.
- Capacidade de armazenagem de até 20 memórias para cada tocha.
- Suporte para as 3 tochas.
- Gás independente para cada tocha / programa.
- Suporte para botijas de gás: 2 de 140 mm de diâmetro ou 1 de 230 mm.
- Tubo em forma de Y que permite utilizar o mesmo gás em duas tochas diferentes.

INCLUÍ:



Ref. STK0294

CARACTERÍSTICAS TÉCNICAS

	50/60Hz	A	I ₂		Regulation	EN60974-1 40°C			U _o	max	nº/roll	Ø mm		Included	Kg	mm	Kva		
			MMA (A)	TIG (A)		% I max.	I 60%	I 100%				D200 (5kg)	D300 (15kg)					GÁS	NO GÁS
AEROPROCESS 2000	230V-1ph	25A	20-200	20-200	20-200	200@45%	170A	130A	74V	18	→	○	○	0,6-1,0	0,8-1,2	0,6-1,0	19	520x270x380	9
AEROPROCESS TRIO	230V-1ph	25A	20-200	20-200	20-200	200@45%	170A	130A	70V	18	→	○	○	0,6-1,0	-	0,6-1,0	45	915x1345x460	9

ACESSÓRIOS AEROPROCESS 2000



Ref. ST56241
UTS 300
€ 95.00



Ref. ST10253
Carro UTS 400
€ 315.00

ACESSÓRIOS AEROPROCESS TRIO



Ref. ST10520
SPOOL GUN
€ 495.00

AEROPROCESS



AEROPROCESS C

AEROPROCESS DV

AEROPROCESS DV W



320A - 400 A | 400V 3 ph

320A - 400 A | 400V 3 ph

320A - 400 A - 500 A | 400V 3 ph

COMPLETO DESDE

€ **2790.00**

COMPLETO DESDE

€ **3799.00**

COMPLETO DESDE

€ **4827.00**

+ UNIFORME SOLTER DE OFERTA

+ UNIFORME SOLTER DE OFERTA

+ UNIFORME SOLTER DE OFERTA



Equipamento Multiprocesso Sinérgico PULSADO*

Inclui de série o módulo de regulação Wi e uma assinatura da plataforma de gestão WaaS (www.waaswelding.com). Mediante uma interface fácil e intuitiva, poderá ajustar de forma precisa todos os parâmetros da curva de soldadura para todos os materiais e gases, bem como selecionar os processos:

- SC Standard curto-circuito
- PS* Arco Pulsado / Speed Pulse
- DPS* Duplo Arco Pulsado
- ROT* Cordão de raiz
- PSC* Pulsado especial ascendente
- DSC Curto-circuito ascendente

CARACTERÍSTICAS TÉCNICAS

		A	Regulation	EN60974-1 40°C			Uo						
				% I max.	I 60%	I 100%							
AEROPROCESS 320A	50/60Hz	16A	MMA / TIG / MIGMAG	320@45%	280A	250A	62V	18		•	•	0,8-1,2	15
AEROPROCESS 400A	50/60Hz	20A	MMA / TIG / MIGMAG	400@35%	320A	280A	62V	22		•	•	0,8-1,2	22
AEROPROCESS 500A	50/60Hz	26A	MMA / TIG / MIGMAG	500@35%	430A	400A	62V	22		•	•	0,8-1,2	30

AEROPROCESS C		AEROPROCESS DV		AEROPROCESS DVW	
Kg	mm	Kg	mm	Kg	mm
36	920x270 x640	65	655x275 x1005	85	655x275 x1290

CONFIGURE O SEU EQUIPAMENTO!

Versão
Tochas
Sirgas
Rolos
Manómetro
Conjuntos de massa
Acessórios

E muito mais!

UNIFORME SOLDADOR SOLTER DE OFERTA!

AVALIADO EM 119 €!

MIG/MAG

SOLMIG 170i

150A | 7,7 kg
230 V 1 ph

- ✓ ELÉKTRODO
- ✓ MIG/MAG
- ✓ GÁS/NO GÁS
- ✓ TIG



Equipamento Multiprocesso



€ 399.00

KIT MIG
Ref. ST10132

INCLUÍ:



€ 450.00

KIT MIG + MMA + Bobina fio 0,45kg NO GÁS
Ref. STK0241

INCLUÍ:



€ 499.00

KIT MULTIPROCESSO MMA - TIG - MIG/MAG
Ref. STK0248

INCLUÍ:



SOLMIG 180

Ref. ST54004

€ 700.00

180A | 48 kg | 230 V 1 ph

INCLUÍ:



AEROMIG 310 4R

Ref. STK0057

€ 1799.00

300A | 77 kg | 230 V / 400 V 3 ph
> 40% (40°C) | 4 rolos

O nosso Aeromig 310 4R é um equipamento robusto e potente. Com 4 rolos de arraste pode soldar até arame de 1,2 mm. O equipamento de oficina de referência para soldar aço carbono.

INCLUÍ:



CARACTERÍSTICAS TÉCNICAS

	50/60Hz	A	Regulation	EN60974-1 40°C			U _o	max	m/min	n°/roll	Ø mm			kg	mm	Kva		
				% I max.	I 60%	I 100%					GÁS	NO GÁS	Included					
SOLMIG 170i	230V-1ph	16A	20-150	130@35%	99A	77A	58V	12	→	•	•	•	0,6-0,8	0,8-0,9	0,6-0,8	10,15	480x210x335	5,6
SOLMIG 180	230V-1ph	16A	30-180	155@20%	85A	60A	30V	14	→	•	•	•	0,6-1,0		0,6-0,9	48	780x330x600	5,6
AEROMIG 310 4R	230/400V - 3ph	25A	20-300	300@40%	250A	200A	22-48V	20	→	•	•	•	0,6-1,2		0,8-1,2	77	990x380x790	14

SOLPRO 4em1

200A | 29 kg | 230 V 1 ph

- ELÉKTRODO MMA
- TIG - HF DC
- TIG - HF AC
- MIG/MAG



O PRIMEIRO EQUIPAMENTO 4EM 1



O equipamento multiprocesso definitivo, capaz de soldar com todos os processos e materiais, escorvamento TIG por HF e soldadura TIG Alumínio (AC).

INCLUÍ:



€ 2299.00

Ref. STK0262

CARACTERÍSTICAS TÉCNICAS

	50/60Hz	A	I ₂			EN60974-1 40° C			U _o	kg	mm	Kva	
			MMA	TIG DC	TIG AC	MIG/MAG	% I max.	I 60%					I 100%
SOLPRO 4em1	230V-1ph	33A			200A	220A	25%	160A	140A	48	29,8	628x270x453	9

ACESSÓRIOS

Ref. ST10242
Carro SOLPRO
€ 350.00

PLASMA

SOLCUT 5000K PFC

Ref. ST10351

30A | 20 kg | 100%

€ 1399.00



Compressor Incorporado

INCLUÍ:



SOLCUT 6000K PFC DUAL

Ref. ST10360

40A | 23 kg | 35%

€ 1699.00



**Compressor Incorporado
Compressor interno / externo**

INCLUÍ:



Equipamento de corte por plasma com ar comprimido e compressor incorporado.

Tecnologia *Inverter* com PFC (Power Factor Corrector) para um arco de corte muito estável e economia de energia.

O modelo SOLCUT 6000K está equipado com um compressor duplo de DOIS CILINDROS. Pode funcionar com compressor interno e externo.

SOLCUT 50

Ref. ST10133

€ 1199.00



45A | 12 kg
50% PLASMA
a 20°C

INCLUÍ:



SOLCUT 60 PRO

Ref. ST14012

€ 1690.00



60A | 18 kg |
60% PLASMA
a 20°C

INCLUÍ:



SOLCUT 100 PRO

Ref. ST14011

€ 2790.00



100A | 25 kg
60% PLASMA
a 20°C

INCLUÍ:



CARACTERÍSTICAS TÉCNICAS

			U_o	I_2	EN60974-1 40°C													
					% I max.	I 60%	I 100%	Fe	Inox	Alu	Fe	Inox	Alu	Bar	l/min			
SOLCUT 5000K	50/60Hz	A	V	A	30@100%	-	-	8	5	8	6	4	6	-	-	20	440x270x350	3,7
SOLCUT 6000K	230V-1ph	16	240	40	40@35%	35	30	10	6	10	8	5	8	3,5-10bar	150l/min	23	440x270x350	4,7
SOLCUT 50	230V-1ph	16	310	45	45@50%	40A	32A	12	8	12	10	6	10	3,5-10bar	150l/min	12	504x213x314	4,5
SOLCUT 60 PRO	400V-3ph	16	300	60	60@40%	48A	38A	22	15	22	18	12	18	3,5-10bar	150l/min	18	430x170x270	6,5
SOLCUT 100 PRO	400V-3ph	20	300	100	100@60%	100A	80A	35	28	35	30	20	30	3,5-10bar	150l/min	25	530x250x400	8,5

ACESSÓRIOS

	SOLCUT 5000K				SOLCUT 6000K				SOLCUT 100 PRO			
Tocha		Ref. ST30576	PT20C	€ 175.00	Ref. ST55971	PT-60	€ 250.00		Ref. ST56283	PT-120	€ 600.00	
Eléctrodo		Ref. ST55985	Curto PT-20C/60 2un	€ 13.70					Ref. ST56290	Eléctrodo PT 120 2un	€ 11.60	
		Ref. ST55979	Longo PT-20C/60 2un	€ 15.45								
Difusor		Ref. ST56046	Difusor PT-20C/60 1un	€ 17.40					Ref. ST56289	Difusor PT-120 1un	€ 33.00	
Bico		Ref. ST55972	Curto 0,65 10-20A PT-20C/60 2un	€ 6.30					Ref. ST56291	Bico PT-120 2un	€ 8.60	
		Ref. ST55974	Curto 0,8 20-30A PT-20C/60 2un	€ 6.30								
		Ref. ST55982	Curto 0,9 30-40A PT-20C/60 2un	€ 6.30								
		Ref. ST55983	Curto 1,0 40-50A PT-20C/60 2un	€ 6.30								
		Ref. ST55984	Curto 1,1 50-60A PT-20C/60 2un	€ 6.30								
		Ref. ST55973	Longo 0,65 10-20A PT-20C/60 2un	€ 7.30								
		Ref. ST55975	Longo 0,8 20-30A PT-20C/60 2un	€ 7.30								
Ref. ST55978	Longo 0,9 30-40A PT-20C/60 2un	€ 7.30										
Porta-bico		Ref. ST56094	Porta-bico PT20C	€ 15.00	Ref. ST55980	Porta-bico PT-60	€ 15.00		Ref. ST56292	Porta-bico PT-120 1un	€ 45.30	
Escudo									Ref. ST56293	Escudo PT-120 1un	€ 17.35	
									Ref. ST10362	Escudo PT-120 Gouging	€ 15.50	
Patim					Ref. ST55981	Patim PT-60	€ 12.00					
Compasso		Ref. ST10403	Compasso PT-20C/60	€ 197.00		Ref. ST10288	Compas PT-120	€ 180.00				
Carro		Ref. ST10253	UTS 400	€ 315.00								

MAQUINARIA AUXILIAR
SOLSPOT 5000 STEEL + KIT STUDDER

Ref. ST10367

€ 830.00

Máquina especialmente concebida para a reparação de carroçarias de automóveis e camiões de todos os tipos de aços e das suas ligas, ideal para o endireitamento de chapas e aquecimentos localizados com elétrodo de carvão.

Acessórios incluídos:

- Kit Studder (pistola com cabos e kit completo de acessórios para desamolgar)

SOLSPOT 9000 + PINÇA PNEUMÁTICA + KIT STUDDER

Ref. ST10368

€ 3990.00

Máquina ideal para todos os tipos de reparações de carroçarias: soldadura por pontos de chapas e chassis de Automóveis e Camiões (até 3,0 + 3,0 mm), reparação de chapas com spotter (desamolgador), aquecimento localizado de chapas.

Acessórios incluídos:

- Pinça pneumática com L = 2000 mm de 150 mm² e braços com elérodos de 107 mm.
- Kit Studder (pistola com cabos e kit completo acessórios para desamolgar).
- Carro Studder completo.
- Manorredutor de pressão.

CARACTERÍSTICAS TÉCNICAS

	50/60Hz	A	Kva - 50%	Kva - Max	I_2 Amp - Max	Corrente térmica Kva - 100%	U _o V	Tempo de Soldadura Cy	KG
SOLSPOT 5000	230V - 1Ph	8A	2,0Kva	12 Kva	1800A	--	8V	0,5 - 99	16 kg
SOLSPOT 9000	400V - 1PH	25A	10Kva	50Kva	8000A	0,88Kva	8V	1 - 99	105 kg

ASPIRADORES
SOLVAC 200 PRO

Ref. K0290

€ 2090.00

Solução ideal para aspirar os fumos diretamente da tocha de soldadura de tipo MIG-MAG.

Ligado e desligado diretamente pelo equipamento. Até 3 níveis de filtragem com sistema integrado de limpeza do filtro.

SOLVAC 1500 IND

Ref. 10423

€ 2790.00

A unidade de filtragem móvel para fumos de soldadura..

Controlo da sujidade do filtro mediante um contador de horas. Compacto e fácil de manejar. Braço de aspiração integrado de 3 metros. Manutenção rápida e simples do sistema.

CARACTERÍSTICAS TÉCNICAS

	Ligação	Tipo motor	Potência motor	Depressão máxima	Máximo caudal de ar	Nível de ruído		KG
SOLVAC 200 PRO	230V - 3Ph	By-Pass	1 Hp	250mBar	190 m ³ /h	72 dB(A)	534x471x983 mm	36 kg
SOLVAC 1500 IND	400V - 3Ph	Ventilador	1,5 Hp	12,5mBar	1400 m ³ /h	72 dB(A)	700x750x900 mm	80 kg

SOLDADURA DE PLÁSTICO
SOLPLASTIC 2000 K

Ref. 10434

€ 400.00

Soldador de plásticos por ar quente.

Ideal para a reparação de cortes ou orifícios e para a reconstrução de peças e suportes de plástico de para-choques e tabliers ou da carroçaria dos automóveis em geral.

Pode soldar os seguintes tipos de plástico: PP - PC - PP/EDPM - ABS (exceto polietileno "PE" e poliuretano "PUR" ou "PU").

INDUÇÃO
SOLDUCTOR 4000

Ref. 10425

€ 2200.00

Sistema de indução de última geração para o aquecimento específico e preciso de metais.

Reconhecimento automático da ferramenta utilizada.

Ecrã LCD..

Ideal para aquecer longarinas, parafusos de roda, rolamentos, porcas de biela e qualquer outro tipo de metal ferroso em menos de 30 segundos.

CARACTERÍSTICAS TÉCNICAS

Ligação	Fusível	Índice de proteção	Seletor de temperatura		KG
230V - 1pH	16A	IP21	150-480°C	700x750x900 mm	8 kg

CARACTERÍSTICAS TÉCNICAS

Ligação	Fusível	Índice de proteção	Potência absorvida máx.	Frequência de trabalho		KG
230V - 1pH	16A	IP23	3kw	19 KHz	195x360x300 mm	12 kg

OPTIMATIC



OPTIMATIC 45

Ref. ST10490

€29.00



OPTIMATIC 55

Ref. ST06705

€33.00



OPTIMATIC 100

Ref. ST06684

€44.00



PILHA SUBSTITUÍVEL

OPTIMATIC 150 FLIP-UP

Ref. ST10169

€45.00



PILHA SUBSTITUÍVEL

SEGMENTAÇÃO

LINHA	SEGMENTO	MODELOS	ÁREA DE VISÃO	CLASSE	SENSORES	REGULAÇÃO	GAMA DE ESCURECIMENTO	MODO DE ESMERILHAÇÃO	TEMPO DE REAÇÃO		TIPO DE ENERGIA	TRUE-COLOR	PONTO DE FIXAÇÃO A ARNES
									Claro>Escuro	Escuro>Claro			
OPTIMATIC	BEGINNER	OPTIMATIC 45	89x39 mm	1/1/2	2	Analgica (interior)	DIN 4 / 9-13	Não	1 / 25000s	0,1 - 1,0s	Solar com pilha CR2032 substituível	Não	★ STANDARD
		OPTIMATIC 55	96x39 mm			Analgica (interior)		Sim	1 / 25000s	0,1 - 1,0s	Solar com pilha não substituível	Não	
		OPTIMATIC 100	96x39 mm			Analgica (exterior)		Sim	1 / 25000s	0,1 - 1,0s	Solar com pilha CR2032 substituível	Não	
		OPTIMATIC 150 FLIP-UP	89x39 mm			Analgica (interior)		Não				Não	

PROTEÇÃO

HELLMET



Permite a visualização de cores reais através do filtro

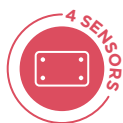

Máxima proteção em qualquer posição



Arnês com 4 pontos de apoio



Apta para todos os processos e correntes



Peso muito reduzido



CE 1/1/1
MÁXIMA QUALIDADE DE FILTRO
TECNOLOGIA TRUE COLOR LCD

HELLMET R-05 BLACK

Ref. ST10486



€ 69.00

HELLMET R-05

Ref. ST10299



€ 69.00

HELLMET



€ 99.00

DEVIL
Ref. ST06772

WELDER
Ref. ST06773

JOB
Ref. ST06770

STEAMPUNK
Ref. ST10300

HELLMET R-10

Ref. ST10044



€ 99.00

Regulação exterior

HELLMET R-20 Di

Ref. ST10170



€ 99.00

Regulação interior digital

HELLMET R-10XL

Ref. ST10075



€ 135.00

FILTRO GRANDE VISÃO
100x100mm

Regulação exterior

HELLMET

NEW



Nova gama de ecrãs EXPERT concebidos para automatizar a configuração dos parâmetros de soldadura.

- Visão panorâmica.
- **Memory System:** armazenamento dos parâmetros de soldadura para os utilizar, sem reconfiguração, quando for necessário.
- **Regulação Digital LCD:** menu digital que apresenta a configuração dos parâmetros de forma mais intuitiva.
- **Função Auto-DIN:** regulação do escurecimento do visor em função do processo de soldadura e das condições ambientais.
- 4 + 1 sensores (5) com deteção de luz ambiente.
- **Comfort Plus:** arnês com 5 pontos de apoio, que proporcionam uma maior fixação e um maior conforto durante o trabalho.
- **Block Function:** função de bloqueio do DIN.
- **Gradient Opening:** processo de abertura (de escuro a claro) de forma progressiva.

HELLMET R-30

Ref. ST10484

€145.⁰⁰



HELLMET R-30 FLIP-UP

Ref. ST10485

€165.⁰⁰



SEGMENTAÇÃO

LINHA	SEGMENTO	MODELOS	ÁREA DE VISÃO	CLASSE	SENSORES	REGULAÇÃO	GAMA DE ESCURECIMENTO	MODO DE ESMERILHAÇÃO	TEMPO DE REAÇÃO		TIPO DE ENERGIA	TRUE COLOR	PONTO DE FIXAÇÃO A ARNÊS			
									Claro>Escuro	Escuro>Claro						
OPTIMATIC	BEGINNER	OPTIMATIC 45	89x39 mm	1/1/2	2	Análogica (interior)	DIN 4 / 9-13	Não	1 / 25000s	0,1 - 1,0s	Solar com pilha CR2032 substituível	Não	★ STANDARD			
		OPTIMATIC 55	96x39 mm			Análogica (interior)					Sim			1 / 25000s	0,1 - 1,0s	Solar com pilha não substituível
		OPTIMATIC 100	96x39 mm			Análogica (exterior)					Sim			1 / 25000s	0,1 - 1,0s	Solar com pilha CR2032 substituível
		OPTIMATIC 150 FLIP-UP	89x39 mm			Análogica (interior)					Não			1 / 25000s	0,1 - 1,0s	Solar com pilha CR2032 substituível
HELLMET	ADVANCED	HELLMET R-05 BLACK	100x53 mm	1/1/2	4	LED (interior)	DIN 3 / 4-8 / 9-13	Sim	1 / 25000s	0,04 - 2,00s	Solar com pilha CR2032 substituível	Sim	★★ COMFORT			
		HELLMET R-05				Análogica (interior)										
	PROFESSIONAL	HELLMET R-20 DI	100x53 mm	1/1/1	4	Digital LCD (interior)	DIN 4 / 5-8 / 9-13	Sim	1 / 30000s	0,1 - 1,0s	Solar com pilha CR2450 substituível	Sim				
		HELLMET R-10	100x60 mm			Análogica (exterior)										
		HELLMET R-10 DEVIL														
		HELLMET R-10 WELDER														
		HELLMET R-10 JOB														
		HELLMET R-10 STEAMPUNK														
		HELLMET R-10 XL												100x100 mm		
		HELLMET R-30												116x81 mm	Digital LCD (exterior) Memory	DIN 3 / 4-8 / 9-14 Auto-Din. Block function
HELLMET R-30 FLIP-UP	Digital LCD (interior) Memory															

PROTEÇÃO

KIT S-MASK-15

Ref. STK0267



€ 60.00

Permite soldar em espaços reduzidos, em que as máscaras de soldadura tradicionais estão limitadas.

Junto com o capuz, oferece uma proteção total da cara, cabeça e ombros.

Pode ser utilizada juntamente com capacetes duros homologados sem nenhum tipo de adaptador.



CAPUZ DE SOLDADURA DE PELE

Ref. ST10298



€ 26.00

S-MASK-15

Ref. ST10322 Ref. ST10298



€ 40.00

CARACTERÍSTICAS TÉCNICAS

	Área de visão	Classe	Sensores	Regulação	Gama de escurecimento	Modo de esmerilação	TEMPO DE REAÇÃO		Tipo de energia	TRUECOLOR
							Claro>Escuro	Escuro>Claro		
S-MASK-15	111x39 mm	1/1/1/2	2	Digital LCD (exterior)	DIN 5-8 / 9-13	Si	1 / 30000s	0,04 - 2,0 s	Bateria substituível CR2450	Não

HELLMET FLOW

Ref. ST10222

€ 699.00



FILTRO GRANDE VISÃO 100x100mm

Máscara de soldadura com unidade de filtro de grande caudal até 220 ml/min.

Bateria de Li-Ion de grande capacidade, com uma autonomia máxima de 10 horas.

UNIDADE DE FILTRO

Fator de proteção nominal: TH3P (Europa).
Caudal: Nivel 1 - 170 nl/min. Nivel 2 - 220 nl/min.
Ventilador: Rolamento de bolas de alta qualidade, motor sem escovas de longa duração.
Fusível: Fusível eletrônico.
Tipo de bateria: Li-Ion recarregável
 Capacidade da bateria: 14,8V 2,2Ah1:10 h

Ciclos de carga: > 500
Tempo de trabalho: Funcionamento nivel 1: 10h. Funcionamento nivel 2: 9 h
Tempo de carregamento: Aprox. 2,5 h
Nivel de ruído máx: 60 db (A)
Alarme óptico e acústico para: Indicação de bateria baixa, filtro obstruído e fluxo de ar insuficiente.

Filtro mestre: Tipo P3 TH3P R SL para sistema TH3P
Conduta de ar: 900x31 mm
Peso: 1097 gr. (incluindo filtro e bateria).
Dimensões: 224x190x70mm
Normas: EN 12941

FILTROS FLOW

Filtro principal TH3P
Ref. 30277

€ 33.00



Pré-filtro
Ref. 30278

€ 5.00



Protetor antifaiscas
Ref. 30287

€ 6.00



TUBO COM BAINHA HELLMET FLOW
Ref. 30281

€ 55.00



BATERIA HELLMET FLOW
Ref. 30280

€ 145.00



CARACTERÍSTICAS TÉCNICAS

	Área de visão	Classe	Sensores	Regulação	Gama de escurecimento	Modo de esmerilação	TEMPO DE REAÇÃO		Tipo de energia	TRUE COLOR	PUNTOS DE SUJECION ARNÉS
							Claro>Escuro	Escuro>Claro			
HELLMET FLOW	100x100 mm	1/1/1/1	4	Análogica (exterior)	DIN 4 / 5-8 / 9-13	Si	1 / 30000s	0,1 - 1,0 s	Solar e bateria substituível CR2450	Si	★ ★ COMFORT

PROTEÇÃO INACTÍNICA MÃO

Ref. ST10283



€9.⁹⁰

PROTEÇÃO INACTÍNICA CABEÇA FLIP-UP

Ref. ST10282



€12.⁹⁰

Vidro inactínico DIN-11 108x50 mm

Ref. ST06075

€1.⁴⁰ /UN

Vidro transparente 106,5x50 mm

Ref. ST10287

€1.³⁰ /UN

ACESSÓRIOS

		Ref.	Dimensões	Modelo	Quantidade	Preço	
PROTETORES POLICARBONATOS		Ref. STST10090	111x90,2 mm	OPTIMATIC 55 / 100 / FLIP-UP	5 un	€ 7.00	
		Ref. ST10088	115x104 mm	HELLMET	5 un	€ 7.00	
		Ref. ST10086	Exterior	117,8x136,5 mm	R-10XL / FLOW	5 un	€ 11.25
		Ref. ST10304			ARADIA	1 un	€ 2.50
		Ref. ST10324			S-MASK	5 un	€ 11.25
		Ref. ST10091		102,5x42,3 mm	OPTIMATIC 55 / 100	5 un	€ 7.10
		Ref. ST10187		94,3x43,2 mm	OPTIMATIC FLIP-UP	5 un	€ 7.10
		Ref. ST10089		99,7x63,5 mm	HELLMET	5 un	€ 7.10
		Ref. ST10087	Interior	108,7x105,2 mm	R-10XL / FLOW	5 un	€ 7.60
		Ref. ST10198		105,8x58,5 mm	R-05 / R-20Di	5 un	€ 7.60
		Ref. ST10305		114,2x89,8 mm	ARADIA	5 un	€ 7.60
Ref. ST10326			S-MASK	5 un	€ 8.00		
BANDAS DE SUOR		Ref. ST73085		OPTIMATIC / HELLMET / CABEZA	1 un	€ 1.80	
		Ref. ST30285		FLOW	1 un	€ 1.80	
		Ref. ST10313		ARADIA	1 un	€ 1.80	
ARNESSES		Ref. ST05904		OPTIMATIC / FOX	1 un	€ 12.00	
		Ref. ST05863		HELLMET	1 un	€ 12.00	
		Ref. ST10314		ARADIA	1 un	€ 15.00	
		Ref. ST30284		FLOW	1 un	€ 25.00	

PROTEÇÃO

TÊXTIL

WELDTEX CASACO & CALÇAS

Equipamento de proteção individual

COMPOSIÇÃO
75% algodão
24% poliéster
1% antiestático

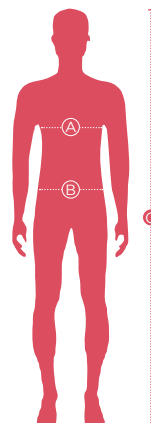

Roupa de proteção contra produtos químicos líquidos.



Roupa de proteção utilizada durante a soldagem e processos afins.



Roupa de proteção contra calor e chamas.



Propriedades eletrostáticas.



Roupa de proteção contra os perigos térmicos de um arco elétrico.

	S	M	L	XL	2XL	3XL	PVP
Casaco	Ref. ST10227	Ref. ST10228	Ref. ST10229	Ref. ST10230	Ref. ST10231	Ref. ST10232	€ 62.00
Calças	Ref. ST10233	Ref. ST10234	Ref. ST10235	Ref. ST10236	Ref. ST10237	Ref. ST10238	€ 57.00

	S	M	L	XL	2XL	3XL
A	88/96	96/104	104/112	112/120	120/128	128/136
B	64/72	72/80	80/88	88/96	96/104	104/112
C	158/164	164/170	170/176	176/182	182/188	188/194

LUVAS DE SOLDADURA PRO

Ref. ST74977



€ 11.00

LUVAS DE SOLDADURA TIG

Ref. ST10295



€ 21.00

AVENTAL DE SOLDADURA

Ref. ST10296



€ 27.00

CAPUZ DE SOLDADURA DE PELE

Ref. ST10298



€ 26.00

CAPUZ DE SOLDADURA TÊXTIL IGNÍFUGO

Ref. ST10439



€ 14.00

POLAINAS DE PELE

Ref. ST10297



€ 20.80

MANGAS DE SOLDADURA DE COURO

Ref. ST10440



€ 21.00

GORRO DE SOLDADURA TÊXTIL IGNÍFUGO

Ref. ST10441



€ 7.50

BANDANA DE SOLDADURA TÊXTIL IGNÍFUGA

Ref. ST10442



€ 7.00

MANTAS



MANTAS IGNÍFUGAS

	TEMPERATURA			
	VERTICAL 600°C Fibra + Silicone		VERTICAL-HORIZONTAL 950°C Fibra + Silicone	
2.000x900	Ref. ST10080	€ 45.25	Ref. ST10081	€ 79.00
2.000x1.860	Ref. ST10082	€ 91.00	Ref. ST10083	€ 159.00
Rolo	Ref. ST10084 50mx1m	€ 390.00	Ref. SY10085 50mx0,914m	€ 850.00

MANTA DE EXTINÇÃO PARA AUTOMÓVEIS

Ref. ST10409

Material:
Fibra de vidro resistente a altas temperaturas

Resistência à temperatura: **550 °C**

Tamanho: **6 x 8 metros**



€ 1100.00



CORTINA DE SOLDADURA



	VERMELHO	VERDE
1.800x1.400	Ref. ST10076 € 36.00	Ref. ST10077 € 36.00
2.000x1.400	Ref. ST10078 € 39.00	Ref. ST10079 € 39.00

Ganchos de suspensão (*6 ganchos por cortina)
Ref. ST06036 € 0.90

PAINEL SOLDADURA



	VERMELHO	VERDE
Painel 1.800x1.800	Ref. ST10098 € 44.00	Ref. ST10099 € 44.00
Estrutura 1.900	Ref. ST10097 € 135.00	
Kit painel	Ref. STK0226 € 174.00	Ref. STK0227 € 174.00

ACESSÓRIOS

PINÇAS & CABOS

PINÇA PARA ELÉTRODOS

- 1 200 A **€ 9,00**
Ref. ST06006
- 2 300 A **€ 14,00**
Ref. ST06005
- 3 500 A **€ 15,20**
Ref. ST06033
- 4 300 A fechada **€ 16,75**
Ref. ST06669
- 5 400 A fechada **€ 18,25**
Ref. ST06578
- 6 600 A fechada **€ 20,90**
Ref. ST06775



PINÇA DE MASSA

- 1 Chapa 200 A **€ 4,60**
Ref. ST06037
- 2 Chapa 400 A **€ 8,25**
Ref. ST06038
- 3 Latão 200 A **€ 8,65**
Ref. ST06023
- 4 Latão 400 A **€ 14,00**
Ref. ST06129
- 5 Parafuso 300 A **€ 15,50**
Ref. ST06159
- 6 Parafuso 600 A **€ 20,50**
Ref. ST10225



CABO DE SOLDADURA DE COBRE

	16 mm ² - Ref. ST06010 € 5,10
	25 mm ² - Ref. ST06011 € 8,20
	35 mm ² - Ref. ST06039 € 10,80
	50 mm ² - Ref. ST06157 € 15,00
	70 mm ² - Ref. ST06158 € 21,75

TERMINAIS CABO SOLDADURA

SEÇÃO CABO	MEDIDA PARAFUSO M	MEDIDA PARAFUSO M					Blister 10un
		M5	M6	M8	M10	M12	PVP
A3	Ø 16 mm	Ref. 10337	Ref. 10338	Ref. 10339	Ref. 10340		€ 10,00
A5	Ø 25 mm			Ref. 10341	Ref. 10342		€ 12,00
A7	Ø 35 mm		Ref. 10343		Ref. 10344		€ 15,00
A10	Ø 50 mm		Ref. 10345		Ref. 10346	Ref. 10347	€ 20,00
A14	Ø 70 mm				Ref. 10348	Ref. 10349	€ 45,00

PICARETAS & ESCOVAS



- 1 Picareta de aço do punho de madeira **€ 6,15**
Ref. ST06003
- 2 Picareta metálica **€ 8,10**
Ref. ST06004
- 3 Conjunto escova + martelo **€ 5,90**
Ref. ST10101
- 4 Escova martelo **€ 3,50**
Ref. ST06774
- 5 Escova duplas cerdas aço **€ 3,00**
Ref. ST06019

CONJUNTOS MONTADOS

Amp	m	CONJUNTO DE MASSA								
		conector	Ø 16 mm	PVP	Ø 25 mm	PVP	Ø 35 mm	PVP	Ø 50 mm	PVP
200A	2	10-25	Ref. 06123	€ 27,75						
200A	3	10-25			Ref. 06148	€ 39,50				
200A	3	35-50			Ref. 06165	€ 45,50				
200A	5	35-50			Ref. 10333	€ 61,00				
400A	3	35-50					Ref. 06114	€ 55,00		
400A	4	35-50					Ref. 06130	€ 64,75		
600A	3	35-50							Ref. 10199	€ 88,00

Amp	m	CONJUNTO PORTA-ELÉTRODO						
		conector	Ø 16 mm	PVP	Ø 25 mm	PVP	Ø 35 mm	PVP
200A	3	10-25	Ref. 06124	€ 33,40				
200A	3	10-25			Ref. 06009	€ 37,00		
200A	3	35-50			Ref. 06126	€ 42,00		
200A	4	35-50			Ref. 06704	€ 50,55		
200A	5	35-50			Ref. 10334	€ 63,83		
500A	4	35-50					Ref. 10200	€ 72,00

CONECTORES

2 unidades

AÉREOS MACHO



- Ref. ST05947
Macho 10/25 2u **€ 5,10**
A (9,0mm) - B (25,0mm)
- Ref. ST05948
Macho 35/50 2u **€ 10,40**
A (13,0mm) - B (35mm)

AÉREOS FÊMEA



- Ref. ST05945
Fêmea 10/25 2u **€ 6,25**
A (9,0mm) - B (25,0mm)
- Ref. ST05946
Fêmea 35/50 2u **€ 13,30**
A (13,0mm) - B (35,0mm)

FIJOS FÊMEA

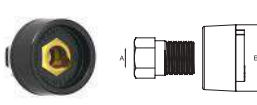

- Ref. ST06121
Fêmea 10/25 2u **€ 5,15**
A (9,0 mm) - B (32,0mm)
- Ref. ST06122
Fêmea 35/50 2u **€ 10,60**
A (13,0mm) - B (40,0mm)

ADAPTADOR



- Ref. ST10404
Adaptador 10/25 a 35/50 2u **€ 11,50**

ACESSÓRIOS

TOCHA MIG

Modelo	Comprimento	Ref.	Preço	MOLA		SUPORTE DE TUBO		BICO	
				Ref.	Preço	Ref.	Preço	Ref.	Preço
SX-15	3m*	ST56031	€ 52.50	Ref. ST56060	€ 1.50	Ref. ST05939	€ 2.55	Ref. ST05936	€ 3.75
	4m	ST56200	€ 64.50						
SX-25	3m*	ST56052	€ 76.00	Ref. ST56061	€ 1.50	Ref. ST05940 (M6)	€ 2.60	Ref. ST05937	€ 6.20
	4m	ST56032	€ 76.00						
	5m	ST68016	€ 99.50						
SX-36	3m*	ST56077	€ 104.00	Ref. ST05943	€ 1.80	Ref. ST05941 (M6)	€ 2.60	Ref. ST05938	€ 10.20
	4m	ST56033	€ 104.00						
SX-501	3m*	ST56078	€ 157.00	Ref. ST05944	€ 1.80	Ref. ST05942	€ 2.60	Ref. ST05886	€ 9.50
	4m	ST56075	€ 157.00						

*com bicha de teflón

PONTAS DE CONTACTO

Modelo	Comprimento	Ref.	Cu		CuCrZr	
			Ref.	Preço	Ref.	Preço
Ponta M6 L25	10 un	Ref. ST56009	0,6 mm	€ 4.50	Ref. ST06760	€ 7.50
			0,8 mm	€ 4.50		
			1,0 mm	€ 4.50		
Ponta M6 L28	10 un	Ref. ST56028	0,8 mm	€ 6.00	Ref. ST06761	€ 7.50
			1,0 mm	€ 6.00		
			1,2 mm	€ 6.00		
Ponta M8 L30	10 un	Ref. ST06345	0,8 mm	€ 8.90	Ref. ST06714	€ 11.00
			1,0 mm	€ 8.90		
			1,2 mm	€ 8.90		
			1,6 mm	€ 8.90		

BAINHAS

Material	Comprimento	Ref.	Preço
Metal Aço (1)	0,6-0,8 4 m	Ref. ST56065	€ 4.00
	1,0-1,2 4 m	Ref. ST56064	€ 4.00
	1,0-1,2 5 m	Ref. ST10335	€ 4.90
	1,2-1,6 4 m	Ref. ST56058	€ 4.00
Poliamida-Metal Alumínio-Inox (2)	0,8 -1,0 4 m	Ref. ST06721	€ 19.00
	1,0-1,2 4 m	Ref. ST06765	€ 19.00
	1,2-1,6 4 m	Ref. ST06722	€ 19.00

QUÍMICOS PARA A SOLDADURA

SPRAY ANTIOXIDANTE



€ 7.00 (1)

€ 10.50 (2)

AS-04 (400 ml)

Galvanizado brilhante (1) Ref. ST06756

AS-06 (400 ml)

Inox brilhante (2) Ref. ST06757
Sprays protetores antioxidantes de longa duração com acabamento brilhante. Ideais para tratar superfícies e soldaduras.

SPRAY ANTIPROJEÇÕES



€ 6.40

AS-02 (400 ml) Ref. ST06750

Espray antiproyecciones base agua AS-02, libre de siliconas. Alarga la vida de tus antorchas y consumibles. Evita la adherencia de proyecciones en las piezas soldadas. Pulverización a 360°, no corrosivo y compatible con procesos de pintado.

GEL DECAPANTE PARA INOX



€ 51.50

AS-10 (2 kg) Ref. ST06758

O Gel decapante AS-10 elimina o enegrecimento do cordão de soldadura e das zonas afetadas pelo calor do arco elétrico, bem como as manchas de óxido, em aços especiais, níquel e as suas ligas, e ligas de cuproníquel. Grande rapidez de ação | Fácil aplicação | Excelente adesão ao material de base | Sem perigo de picagem devido à ausência de compostos de cloro.

LÍQUIDO REFRIGERANTE PARA TOCHAS 5L



€ 29.00

Não tóxico. Ref. ST10214
Proteção anticongelante -10 °C.
Alta resistividade elétrica.
Não volátil, não infl amável.
Anticorrosão.

MARCADOR DE GIZ PARA SOLDADURA

Ref. ST10359
5 un € 8.00

TOCHA TIG



	REF.	EXTENSÃO	CONECTOR	PVP	OPÇÃO GOLA FLEXÍVEL
SR-17V 140A - 60%	Ref. ST06024	4m	10-25	€ 76. ⁰⁰	Ref. ST30240 + € 22. ⁰⁰ 
	Ref. ST06031	4m	35-50	€ 77. ⁰⁰	
SR-9 110A - 60%	Ref. ST10280	4m	10-25	€ 97. ⁰⁰	Ref. ST30241 + € 24. ⁰⁰
	Ref. ST10281	8m		€ 143. ⁰⁰	
SR-17 140A - 60%	Ref. ST06145	4m	10-25	€ 89. ⁹⁰	Ref. ST30301 + € 27. ⁰⁰
	Ref. ST06161	8m		€ 171. ⁰⁰	
SR-26 200 - 60%	Ref. ST06029	4m	35-50	€ 125. ⁰⁰	Ref. ST68059 + € 31.45
	Ref. ST06700	8m		€ 215. ⁰⁰	
SR-18W 320 - 100%	Ref. ST56076	4m	35-50	€ 176. ⁰⁰	Ref. ST68091 + € 57. ⁰⁰
	Ref. ST56235	8m		€ 390. ⁰⁰	

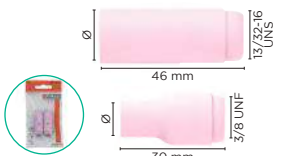

SR-17/26/18	BICOS CERÂMICOS 2un				€ 2.20
GR4 Ø6,5 Ref. ST06200	GR5 Ø8 Ref. ST06343	GR6 Ø9,5 Ref. ST06201	GR7 Ø11 Ref. ST06344	GR8 Ø12,5 Ref. ST06202	
SR-9/20	BICOS CERÂMICOS 2un				€ 1.70
GR4 Ø6,5 Ref. ST10264	GR5 Ø8 Ref. ST10265	GR6 Ø9,5 Ref. ST10266	GR7 Ø11 Ref. ST10267	GR8 Ø12,5 Ref. ST10268	

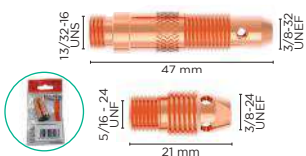

SR-17/26/18	DIFUSOR DE GÁS 2un					€ 3.70
Ø1 Ref. ST06203	Ø1,6 Ref. ST06244	Ø2 Ref. ST06245	Ø2,4 Ref. ST06246	Ø3,2 Ref. ST06247	Ø4 Ref. ST06204	
SR-9/20	DIFUSOR DE GÁS 2un					€ 4.60
Ø1,6 Ref. ST10192	Ø2 Ref. ST10193	Ø2,4 Ref. ST10194	Ø3,2 Ref. ST10195			

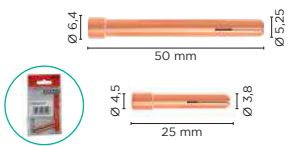

SR-17/26/18	SUPORTE PARA ELÉTRODOS DE TUNGSTÊNIO 2un					€ 2.05
Ø1 Ref. ST06220	Ø1,6 Ref. ST06240	Ø2 Ref. ST06241	Ø2,4 Ref. ST06242	Ø3,2 Ref. ST06243	Ø4 Ref. ST06221	
SR-9/20	SUPORTE PARA ELÉTRODOS DE TUNGSTÊNIO 2un					€ 1.55
Ø1,6 Ref. ST10262	Ø2 Ref. ST10261	Ø2,4 Ref. ST10196	Ø3,2 Ref. ST10263			

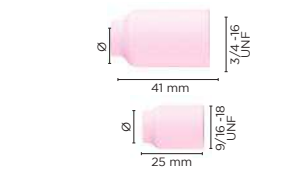

SR-17/26/18	TOBERAS CERÂMICAS LENS 2un		€ 5.95	SR-17/26/18	€ 4.50
GR5 Ø8 Ref. ST06711	GR7 Ø11 Ref. ST06712	GR10-12 Ø19 Ref. ST06713		Isolador bico gas lens Ref. ST06707	
SR-9/20	TOBERAS CERÂMICAS LENS 2un		€ 6.10	SR-9/20	€ 4.50
GR5 Ø8 Ref. ST10153	GR7 Ø11 Ref. ST10270			Isolador bico gas lens Ref. ST10155	

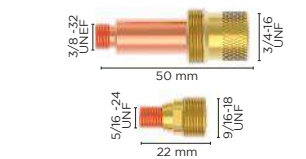

SR-17/26/18	DIFUSOR GAS LENS 2un		€ 9.95
Ø1,6 Ref. ST06708	Ø2 Ref. ST06709	Ø2,4 Ref. ST06710	
SR-9/20	DIFUSOR GAS LENS 2un		€ 10.95
Ø1,6 Ref. ST10154	Ø2 Ref. ST10269	Ø2,4 Ref. ST10197	



SR-17/26/18	TAMPA TIG		€ 1.75
Tampa longa Ref. ST06085	Tampa curta Ref. ST06119		
SR-9/20	TAMPA TIG		€ 2.80
Tampa longa Ref. ST10189	Tampa média Ref. ST10190	Tampa curta Ref. ST10191	

PACK ACESSÓRIOS TIG SR 17/26/18

Ref. STK0265

Bicos cerâmicos
GR5 D8 2 ud
+ GR6 D9,5 2 ud
+ GR7 D11 2 ud

Difusor de gás
D1,6 2 ud + D2 2 ud
+ D2,4 2 ud

Suporte para elétrodos de tungstênio
D1,6 2 ud + D2 2 ud
+ 2,4 2 ud

Tampa longa + Tampa curta



€ 26.⁰⁰

ACESSÓRIOS

REGULADOR

R25 ARG/CO²
Ref. ST56246

R25 Acetileno
Ref. ST56244

R25 Oxigênio
Ref. ST56247



€ 63.00

R25 Propano
Ref. ST56248

R25 Flutómetro ARG/CO²
Ref. ST56245



€ 75.00

FLUXÓMETRO

Ref. ST10185



€ 5.00

GARRAFA DE GÁS

ARGÓN 100%
TIG - Todos os materiais
MIG - Alumínio
Ref. 10245



€ 43.00

ARG/CO²

Ref. ST56008



€ 32.00

PORCA 1/4 GÁS +

ESPIGA TUBO 6mm

Ref. ST10332



€ 5.65

TUBO GÁS PRETO

6x12 mm (1 metro)

Ref. ST30007



€ 5.50

FIXAÇÃO ESQUADROS

MAGNET ECO

Ref. ST10218
Medidas
82x117x14 mm
11 kg

€ 5.50



Ref. ST06160
Medidas
102x155x17 mm
23 kg

€ 8.90

Ref. ST10219
Medidas
122x190x24 mm
34 kg

€ 12.10

MAGNET D



Ref. ST06742

Esquadro multi-ângulo
30° 45° 60° 90°

Medidas
90x75x15 mm

€ 13.95

MAGNET D-SWITCH 30

Ref. ST06751

Medidas
111x95x25 mm

Ângulo 45° / 90°

iCom Interruptor!



€ 55.00

MAGNET D-SWITCH 75

Ref. ST06752

Medidas
152x130x35 mm
Ângulo 45° / 90°

iCom Interruptor!

€ 99.00



MAGNET L

Ref. ST06744

Esquadro multi-ângulo
exterior/interior
30° 45° 60° 90°

Medidas 165x110x20 mm

€ 20.50

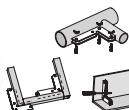

MAGNET ADJ

Ref. ST06743

Esquadro regulável
30° - 270°

Medidas
156x156x20 mm

€ 27.75

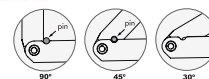

MASSAS

MAGNET 200

Ref. ST10306

Medidas
Ø50 mm
200Amp - 60%

€ 9.90



MAGNET 300 SWITCH

Ref. ST06753

Medidas
50x50x64 mm
300Amp - 60%

iCom interruptor!

€ 89.25



MAGNET 500 SWITCH

Ref. ST06754

Medidas
50x70x64 mm
500Amp - 60%

iCom Interruptor!

€ 107.00



TORNO
2 eixos 64 mm

Ref. ST10167

€ 97.00



TORNO
2 eixos 95 mm

Ref. ST10168

€ 132.00



ALICATES SOLDADURA

Ref. ST10166

€ 19.50



MESA SOLDADURA

Ref. ST10165



€ 480.00

Orifícios 16 mm
Espessura prato 4 mm
Dimensões prato 900x600 mm
1 mesa / 2 alturas (158 mm - 860 mm)

CONSUMÍVEIS KANGAROO

BLÍSTERS ELÉTRÓDOS



ELÉTRÓDO RUTILO

1,6 mm 35 ud	Ref. ST05905	€ 6.25
2 mm 35 ud	Ref. ST05965	
2,5 mm 30 ud	Ref. ST05966	€ 5.05
3,2 mm 20 ud	Ref. ST05967	
4 mm 12 ud	Ref. ST05968	



ELÉTRÓDO INOXIDABLE

2 mm 10 ud	Ref. ST05964	€ 6.15
2,5 mm 10 ud	Ref. ST05974	€ 7.55



ELÉTRÓDO BÁSICO

2,5 mm 10 ud	Ref. ST05973	€ 4.35
-----------------------	--------------	---------------



ELÉTRÓDO FERRO FUNDIDO

2,5 mm 10 ud	Ref. ST05976	€ 22.70
-----------------------	--------------	----------------



ELÉTRÓDO ALUMÍNIO

2,5 mm 10 ud	Ref. ST05975	€ 14.30
-----------------------	--------------	----------------

FORNO ELÉTRÓDOS

Ref. ST06097



€ 185.00

Interruptor ON / OFF.
Luz indicadora de marcador.
Faixa de temperatura:
50 a 300°C regulável.
Com termostato.
Indicador de temperatura.
Capacidade de 10kg (Eletrodos de 450mm).
Dimensões 620x200x180.

Há mais de 20 anos que a **Kangaroo Welding** realiza um importante trabalho no mundo dos consumíveis de soldadura.



ELÉTRÓDOS

KSE 5907

Soldadura de aços carbono em todas as posições. Fácil de escorvar e reescorvar. Autodispensamento da escória. Aspetto do cordão de qualidade excelente.

Código	Descrição	Ø	L	U. Kg	Pac./Caixa	Kg Pac.	U. Pac.	U. Caixa	Kg/Caixa	Código Ean
E6013-1.6KW	KSE 5907	1,6 mm	275	146,0	3	5	730	2190	15	8435442600099
E6013-2.0KW	KSE 5907	2,0 mm	275	97,6	3	5	488	1464	15	8435442600105
E6013-2.5KW	KSE 5907	2,5 mm	350	52,0	3	5	260	780	15	8435442600112
E6013-3.2KW	KSE 5907	3,2 mm	350	33,0	3	5	165	495	15	8435442600129
E6013-4.0KW	KSE 5907	4,0 mm	350	22,0	3	5	110	330	15	8435442600136
E6013-5.0KW	KSE 5907	5,0 mm	350	14,0	3	5	70	210	15	8435442600143

SUPERGREEN

Código	Descrição	Ø	L	U. Kg	Pac./Caixa	Kg Pac.	U. Pac.	U. Caixa	Kg/Caixa	Código Ean
E6013-2.0KWG	Supergreen	2,0 mm	350	79,0	6	2	158	948	12	8435442603816
E6013-2.5KWG	Supergreen	2,5 mm	350	52,5	6	2	105	630	12	8435442603823
E6013-3.2KWG	Supergreen	3,2 mm	350	34,0	6	2	68	408	12	8435442603830
E6013-4.0KWG	Supergreen	4,0 mm	350	21,5	6	2	43	258	12	8435442603847

KSE 7018

Eléctrodo de soldadura com revestimento básico e baixo conteúdo em hidrogénio. Muito boas propriedades mecánicas. Resultados ótimos em controlos de raios X. Cordões suaves, limpos, com poucas projecções e escória de fácil eliminação.

Código	Descrição	Ø	L	U. Kg	Pac./Caixa	Kg Pac.	U. Pac.	U. Caixa	Kg/Caixa	Código Ean
E7018-2.5KW	KSE 7018	2,5 mm	350	42,2	3	5	211	633	15	8435442600198
E7018-3.2CKW	KSE 7018	3,2 mm	350	28,6	3	5	143	429	15	8435442600204
E7018-3.2LKW	KSE 7018	3,2 mm	450	21,2	3	5	106	318	15	8435442600211
E7018-4.0LKW	KSE 7018	4,0 mm	450	14,4	3	5	72	216	15	8435442600235
E7018-5.0KW	KSE 7018	5,0 mm	450	9,2	3	5	46	138	15	8435442600242

KSE 6905

Código	Descrição	Ø	L	U. Kg	Pac./Caixa	Kg Pac.	U. Pac.	U. Caixa	Kg/Caixa	Código Ean
E7016-2.5EP	KSE 6905	2,5 mm	350	50,0	6	1,5	75	450	9	8435442600389
E7016-3.2CEP	KSE 6905	3,25 mm	350	31,3	6	1,6	50	300	9,6	8435442600396
E7016-3.2LEP	KSE 6905	3,25 mm	450	23,7	6	1,9	45	270	11,4	8435442600402
E7016-4.0CEP	KSE 6905	4,0 mm	350	20,0	6	1,5	30	180	9	8435442600419
E7016-4.0EP	KSE 6905	4,0 mm	450	15,0	6	2	30	180	12	8435442600462
E7016-5.0EP	KSE 6905	5,0 mm	450	11,9	6	2,1	25	150	12,6	8435442600433

KSE 205

Soldadura de aços inox de máxima qualidade (316L). Baixo conteúdo em carbono e muito boa soldabilidade em aços 18/8/2 CrNi. Cordão brilhante com máxima resistência à corrosão.

Código	Descrição	Ø	L	U. Kg	Pac./Caixa	Kg Pac.	U. Pac.	U. Caixa	Kg/Caixa	Código Ean
E316-1.6KS	KSE 205	1,6 mm	250	163,0	5	2	326	1630	10	8435442601720
E316-2.0KS	KSE 205	2,0 mm	300	89,0	5	2	178	890	10	8435442601737
E316-2.5KS	KSE 205	2,5 mm	300	57,0	5	2	114	570	10	8435442601744
E316-3.2KS	KSE 205	3,2 mm	350	29,0	5	2	58	290	10	8435442601768
E316-4.0KS	KSE 205	4,0 mm	350	19,0	5	2	38	190	10	8435442601775



Eléctrodo ecológico com revestimento tipo rutilo. Uma formulação específica que lhe permite diminuir em 20% a emissão de fumos, bem como proporcionar uma limpeza de escória e uma qualidade do cordão de soldadura inigualáveis.



Eléctrodo de soldadura básico com excelente soldabilidade devido ao seu duplo revestimento, incluindo em corrente alternada. Possui um arco muito estável sendo ideal para passagens de raiz e soldaduras em posição. Utilização universal para todos os tipos de construções metálicas e manutenção industrial.



CONSUMÍVEIS KANGAROO

KSE 297

Código	Descrição	Ø	L	U. Kg	Pac./Caixa	Kg Pac.	U. Pac.	U. Caixa	Kg/Caixa	Código Ean
E308-1.6KS	KSE 297	1.6 mm	250	165,0	5	2	330	1650	10	8435442601553
E308-2.0KS	KSE 297	2.0 mm	300	89,0	5	2	178	890	10	8435442601560
E308-2.5KS	KSE 297	2.5 mm	300	59,0	5	2	118	590	10	8435442601577
E308-3.2KS	KSE 297	3.2 mm	350	29,0	5	2	58	290	10	8435442601584



Eléctrodo com revestimento de rutilo, para soldar aços inox austeníticos com conteúdo especialmente baixo em carbono, capaz de suportar temperaturas de trabalho até 350 °C. Metal depositado de aço Cr-Ni. Para chapa 304 e 308.

KSE 298

Código	Descrição	Ø	L	U. Kg	Pac./Caixa	Kg Pac.	U. Pac.	U. Caixa	Kg/Caixa	Código Ean
E309-2.0KS	KSE 298	2.0 mm	300	89,0	5	2	178	890	10	8435442601843
E309-2.5KS	KSE 298	2.5 mm	300	57,0	5	2	114	570	10	8435442601850
E309-3.2KS	KSE 298	3.2 mm	350	29,0	5	2	58	290	10	8435442601867
E309-4.0KS	KSE 298	4.0 mm	350	19,0	5	2	38	190	10	8435442601874



Eléctrodo com revestimento de rutilo para soldar aços inox com conteúdo muito baixo em carbono, para soldaduras de aços cromo-níquel de tipo 24 Cr/13 Ni/ e soldaduras heterogêneas entre aço carbono e aço inox.

KSE 201

Código	Descrição	Ø	L	U. Kg	Pac./Caixa	Kg Pac.	U. Pac.	U. Caixa	Kg/Caixa	Código Ean
E312-2.5KS	KSE 201	2.5 mm	300	60,0	5	2	120	600	10	8435442602123
E312-3.2KS	KSE 201	3.2 mm	350	30,0	5	2	60	300	10	8435442602130
E312-4.0KS	KSE 201	4.0 mm	350	21,0	5	2	42	210	10	8435442602147



Eléctrodo UNIVERSAL para soldadura de peças de todos os tipos, incluindo em caso de composição desconhecida. Ideal para soldar materiais diferentes entre si (diferentes tipos de inox, inox com aço carbono, etc.).

KSE 4047 Eléctrodo para união e revestimento hardfacing de ligas 5%-6%-12% Si. Recomendado para o preenchimento de cavidades e para a soldadura de gretas. Recomendada a secagem dos eléctrodos. Ao abrir, manter a 100 °C até à utilização.

Código	Descrição	Ø	L	U. Kg	Pac./Caixa	Kg Pac.	U. Pac.	U. Caixa	Kg/Caixa	Código Ean
E4047-2.5EP	KSE 4047	2.5 mm	350	108,0	4	2	216	864	8	8435442602710
E4047-3.2EP	KSE 4047	3.2 mm	350	73,0	4	2	146	584	8	8435442602727
E4047-4.0EP	KSE 4047	4.0 mm	350	51,0	4	2	102	408	8	8435442602734



KSE NIFE Eléctrodo com alma de ferro-níquel, para união e revestimento de peças fundidas. Garante uma alta segurança contra a fissuração, especialmente indicado para fundição nodular e uniões com aço. Dureza aprox. 220 HB.

Código	Descrição	Ø	L	U. Kg	Pac./Caixa	Kg Pac.	U. Pac.	U. Caixa	Kg/Caixa	Código Ean
ENIFE-2.5KW	KSE NIFE	2.5 mm	300	59,5	5	2	119	595	10	8435442602604
ENIFE-3.2KW	KSE NIFE	3.2 mm	350	32,5	5	2	65	325	10	8435442602611
ENIFE-4.0KW	KSE NIFE	4.0 mm	350	21,0	5	2	42	210	10	8435442602628



KSE CORTEN Eléctrodo de soldadura com revestimento básico e baixo conteúdo de hidrogénio, que deposita um aço ligado a CuNiCr, para soldadura de todos os tipos de aços resistentes à corrosão atmosférica.

Código	Descrição	Ø	L	U. Kg	Pac./Caixa	Kg Pac.	U. Pac.	U. Caixa	Kg/Caixa	Código Ean
ECORTEN-2.5KW	KSE 7907	2.5 mm	350	44,0	3	5	220	660	15	8435442600563
ECORTEN-3.2KW	KSE 7907	3.2 mm	350	28,0	3	5	140	420	15	8435442600570
ECORTEN-4.0KW	KSE 7907	4.0 mm	350	19,0	3	5	95	285	15	8435442600594



GALVA Soldadura de aços suaves, aços de baixa liga e aços de baixo teor de carbono. Possui um ponto de fusão muito baixo, o que o torna indicado para a soldadura de chapa galvanizada.

Código	Descrição	Ø	L	U. Kg	Pac./Caixa	Kg Pac.	U. Pac.	U. Caixa	Kg/Caixa	Código Ean
EGALVA-2.0KW	KSE 5903	2.0 mm	300	82	5	2	164	820	10	8435442600471
EGALVA-2.5KW	KSE 5903	2.5 mm	350	46	5	2	92	460	10	8435442600488
EGALVA-3.2KW	KSE 5903	3.2 mm	350	29	5	2	58	290	10	8435442600495
EGALVA-4.0KW	KSE 5903	4.0 mm	350	19	5	2	38	190	10	8435442600501



KSE 59 HRC Eléctrodo para revestimento hardfacing com uma grossa camada exterior de carbonetos de cromo, para peças submetidas a abrasão combinada com impacto médio. Possui um grande campo de fusão com cordões lisos e com escória de fácil eliminação. Apto para o revestimento de peças de aços carbono, aços manganésio e aço fundido. 58-60 HRC

Código	Descrição	Ø	L	U. Kg	Pac./Caixa	Kg Pac.	U. Pac.	U. Caixa	Kg/Caixa	Código Ean
E59HRC-2.5KW	KSE 59 HRC	2.5 mm	350	35,8	4	5	179	716	20	8435442603809
E59HRC-3.2KW	KSE 59 HRC	3.2 mm	350	18,6	4	5	93	372	20	8435442602451
E59HRC-4.0LKW	KSE 59 HRC	4.0 mm	450	9,6	4	5	48	192	20	8435442603571



KW 63 HRC Eléctrodo para revestimento hardfacing com uma grossa camada exterior de carbonetos de cromo, para peças submetidas a abrasão combinada com impacto médio. Possui um grande campo de fusão com cordões lisos e com escória de fácil eliminação. Apto para o revestimento de peças de aços carbono, aços manganésio e aço fundido.

Código	Descrição	Ø	L	U. Kg	Pac./Caixa	Kg Pac.	U. Pac.	U. Caixa	Kg/Caixa	Código Ean
E63HRC-3.2KW	KSE 63 HRC	3.2 mm	450	25,56	3	4,5	115	345	13,5	8435442602512
E63HRC-4.0KW	KSE 63 HRC	4.0 mm	450	16	3	4,5	72	216	13,5	8435442602529





FIOS

			Ø				
			0,6	0,8	1,0	1,2	1,6
AÇO SUAVE	KSM 70S-6	D200 5 kg	HSGII-0.6PKW	HSGII-0.8PKW	HSGII-1.0PKW		
		D300 15 kg	HSGII-0.6KW	HSGII-0.8KW	HSGII-1.0KW	HSGII-1.2KW	HSGII-1.6KW
AÇO INOX	KSM 316LSi	D200 5 kg		H316-0.8PKW	H316-1.0PKW	H316-1.2PKW	
		D300 15 kg		H316-0.8	H316-1.0	H316-1.2	H316-1.6
	KSM 308LSi	D200 5 kg		H308-0.8PKW	H308-1.0PKW		
		D300 15 kg		H308-0.8	H308-1.0	H308-1.2	H308-1.6
KSM 309LSi	D200 5 kg		H309-0.8	H309-1.0	H309-1.2		
	D300 15 kg						
ALUMÍNIO	KSM AlMg5	D200 2 kg		H5356-0.8PKW	H5356-1.0PKW	H5356-1.2PKW	
		D300 7 kg		H5356-0.8KW	H5356-1.0KW	H5356-1.2KW	
	KSM AlSi5	D200 2 kg		H4043-0.8PKW	H4043-1.0PKW	H4043-1.2PKW	
		D300 7 kg		H4043-0.8KW	H4043-1.0KW	H4043-1.2KW	
MACIÇO BAIXA LIGA	KSM 100	D300 15 kg		H100-0.8KW	H100-1.0KW	H100-1.2KW	H100-1.6KW
	KSM CORTEN	D300 15 kg		HCORTEN-0.8KW	HCORTEN-1.0KW	HCORTEN-1.2KW	
FIO TUBULAR SEM GÁS	KSHT 71T-1	D300 15 kg			H71T1-1.0KW	H71T1-1.2KW	
	HT71TGS	D200 4,5 kg		HT71TGS-0.8PKW	HT71TGS-0.9PKW	HT71TGS-1.0PKW	
D100 (0,45 kg / 0,9 kg)				HT71TGS-0.8MKW	HT71TGS-0.9MKW		



VARAS

			Ø							
			0,8	1,0	1,2	1,6	2,0	2,4	3,2	4
AÇO CARBONO	KST 70S-6	5 kg		VSGII-1.0	VSGII-1.2	VSGII-1.6	VSGII-2.0	VSGII-2.4	VSGII-3.2	VSGII-4.0
AÇO INOX	KST 316LSi	5 kg	V316S-0.8	V316S-1.0	V316S-1.2	V316S-1.6	V316S-2.0	V316S-2.4	V316S-3.2	V316S-4.0
	KST 308LSi	5 kg		V308S-1.0	V308S-1.2	V308S-1.6	V308S-2.0	V308S-2.4	V308S-3.2	
	KST 309LSi	5 kg				V309S-1.6	V309S-2.0	V309S-2.4	V309S-3.2	
ALUMÍNIO	KST AlMg5	5 kg				V5356-1.6	V5356-2.0	V5356-2.4	V5356-3.2	V5356-4.0
	KST AlSi5	5 kg				V4043-1.6	V4043-2.0	V4043-2.4	V4043-3.2	V4043-4.0

ELÉTRÓDOS DE TUNGSTÊNIO

CURRENT	VERDE 100% Tungsténio 10 un	CINZA 2% Cério 10 un	OURO 1,5% Lantânio 10 un	AZUL 2% Lantânio 10 un	BRANCO 0,8% Zircónio 10 un
	AC	AC / DC	DC	DC	AC
Ref.	Ref.	Ref.	Ref.	Ref.	Ref.
Ø 1,0 mm	ST06207 € 12.85	ST06209 € 12.90	ST06214 € 12.90	ST10172 € 15.55	ST10177 € 12.95
Ø 1,6 mm	ST06150 € 15.80	ST06177 € 15.70	ST06215 € 19.90	ST10173 € 18.90	ST10178 € 15.50
Ø 2,0 mm	ST06151 € 25.00	ST06210 € 28.59	ST06216 € 28.20	ST10174 € 28.30	ST10179 € 23.50
Ø 2,4 mm	ST06152 € 40.40	ST06211 € 37.55	ST06217 € 36.40	ST10175 € 41.76	ST10180 € 34.70
Ø 3,2 mm	ST06153 € 55.75	ST06212 € 66.50	ST06218 € 67.50	ST10176 € 66.50	ST10181 € 66.50
Ø 4,0 mm	ST06208 € 93.95	ST06213 € 77.85	ST06219 € 80.60		

KIT ELÉTRÓDO TUNGSTÊNIO VERDE PURO Ref. ST10183	2 ud Ø 2 Verde puro 4 ud Ø 2,4 Verde puro 4 ud Ø 3,2 Verde puro	€ 35.00
---	---	----------------



BATERIA

CARREGADORES ALIMENTADORES INTELIGENTES

INVERCAR 1000

Ref. ST10065



€35.00

INVERCAR 3800

Ref. ST10066



€57.00

INVERCAR 7000

Ref. ST10067



€86.00

INVERCAR 15000

Ref. ST10068



€160.00

CARACTERÍSTICAS TÉCNICAS

	50/60Hz	V	I A	Charge Ah	Maintenance Ah	Curve	Steps	IP	g	mm	Battery				Technologies				
											Pb	AGM	GEL	LI-THIUM	Intelli-gent	Repair	Cold	Supply 13,6V	
INVERCAR 1000	220 -240V AC	6/12V	1A	2 - 75Ah	100Ah	IUoU	8	IP54	260	138x60x32	•	•	•	•	•	•	•	•	
INVERCAR 3800	220 -240V AC	6/12V	1 / 3,5A	2 - 120Ah	200Ah	IUoU	8	IP54	496	190x80x45	•	•	•	•	•	•	•	•	
INVERCAR 7000	220 -240V AC	12V	3,5A	2 - 230Ah	All	IUoU	8	IP54	855	300x60x105	•	•	•	•	•	•	•	5A	
		24V	7A	2 - 115Ah															
INVERCAR 15000	220 -240V AC	12V	15 / 20A	2 - 400Ah	All	IUoU	8	IP54	1.445	365x70x123	•	•	•	•	•	•	•	•	10A
		24V	7,5A	2 - 200Ah															

PROFISSIONAIS AUTOMÁTICOS HF



Carregadores de bateria e fontes de alimentação estabilizada totalmente automáticos.

Fontes de alimentação e carregadores para baterias de automóveis. Ideais para utilização no setor automóvel e industrial, os carregadores SOLFLASH têm tecnologia Inverter de alta frequência, e funcionam também como abastecimento de energia de apoio (Power Supply).

Ideal para proporcionar energia contínua para manter acesos os faróis dos coches nas exposições (funcionalidade Showroom).

Os modelos Solflash 70 e 140 possuem uma função de fonte de alimentação estabilizada (até 70 A/140 A) com seleção da corrente fornecida à bateria de 12,0 V a 15,0 V (intervalos de 0,1 V), utilizada para programar unidades de controlo (centrais eletrónicas) e substituições de baterias.

SOLFLASH 30A 12-24V HF

Ref. ST10355



€440.00

SOLFLASH 70A 12V HF

Ref. ST10356

Cabos com pinças incluídos (Carregador e Power Supply)



€630.00

SOLFLASH 140A 12V HF

Ref. ST10357

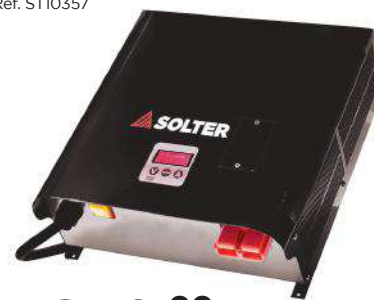

€1370.00

CARACTERÍSTICAS TÉCNICAS

	50/60Hz	V	I A	Charge Ah	Maintenance Ah	Curve	Steps	IP	g	mm	Battery				Technologies					
											Pb	AGM	GEL	LI-THIUM	Intelli-gent	Repair	Cold	Supply	Auto-matic	Alter-nator check
SOLFLASH 30A	220 - 240V AC	12/24V	3 - 30A	30 - 400Ah		IUoI		IP31	3,5	320x140x80	•	•	•	•	•	•	•	30A	•	•
SOLFLASH 70A	221 - 240V AC	12V	3-70A	20 - 840Ah		IUoI		IP31	3	290x180x130	•	•	•	•	•	•	•	70A	•	•
SOLFLASH 140A	222 - 240V AC	12V	3-140A	20 - 1600Ah		IUoI		IP31	6	290x34x130	•	•	•	•	•	•	•	140A	•	•

AUTOMÁTICOS

NOVACAR 10A

Ref. ST05078



€ 65.⁵⁰

NOVACAR 16A

Ref. ST05070



€ 82.⁰⁰

CARACTERÍSTICAS TÉCNICAS

	50/60Hz	V	I A	Charge Ah	Maintenance Ah	Curve	Steps	IP	kg	mm	Battery				Technologies			
											Pb	AGM	GEL	LI-THIUM	Intelligent	Repair	Cold	Supply - 13.6V
NOVACAR 10A	220 -240V AC	12V	3,75 - 8A	20 - 120Ah	225Ah	WoW	2	IP20	3	180x235x105	•	•			•			
NOVACAR 16A	220 -240V AC	12V 24V	12A 7A	20 - 150Ah 20 - 80Ah	300Ah 175Ah	WoW	2	IP20	3,6	180x235x105	•				•			

ARRANCADORES BOOSTER

CARREGADORES-ARRANCADORES

DIGISTART 80

Ref. ST10069



€ 140.⁰⁰

DIGISTART 300

Ref. ST10070



€ 295.⁰⁰

DIGISTART 400

Ref. ST10071



€ 365.⁰⁰

CARACTERÍSTICAS TÉCNICAS

	50/60Hz	V	I A	Charge Ah	Start W	Curve	Steps	IP	kg	mm	Battery			Technologies		
											Pb	AGM	GEL	Automatic	Repair	Alternator check
DIGISTART 80	220 -240V AC	12V	5A / 10A / 20A	2 - 200Ah	80A	IUoI	10	IP33	12	370x410x320	•	•	•	•	•	•
DIGISTART 300	220 -240V AC	12/24V	5A / 15A / 30A / 40A	2 - 300Ah	200A	IUoI	10	IP33	17,5	290x600x250	•	•	•	•	•	•
DIGISTART 400	220 -240V AC	12/24V	20A / 30A / 40A / 60A	2 - 500Ah	300A	IUoI	10	IP33	18,3	290x600x250	•	•	•	•	•	•

BATERIA

ARRANCADORES BOOSTER

MINI-ARRANCADORES LÍLIO

Auto-arrancadores de baterias LITHIUM de 12 V (LT-13/17) ou 12 V/24 V (LT-45), bateria de lítio de altas prestações, para arrancar todos os tipos de veículos a gasolina e diesel, incluindo camiões ou maquinaria de obra pública.

Capazes de aguentar a carga até 6 meses, com um tempo de carregamento de apenas 10 horas. Dispositivos potentes totalmente profissionais.

LITHIUM LT-13 12V

Ref. ST10116



€111.00

LITHIUM LT-17 12V

Ref. ST10115



€159.00

LITHIUM LT-35 12V PRO

Ref. ST10412



€299.00

LITHIUM LT-56 12/24V PRO

Ref. ST10413



€410.00

CARACTERÍSTICAS TÉCNICAS

	Capacity	V	Charge time	Istart	Ipeak	Start	Vehicle	Output	kg	mm
LT-13 12V	10.000mAh	12V	3h	200A	500A		Gasolina/Diesel 2000cc	5V 3A ; 9V 2A ; 5V 2,1A	0,44	164x86x33
LT-17 12V	17.000mAh	12V	4,5h	500A	1200A		Gasolina/Diesel 3000cc	5V 1A ; 5V 2,1A;	0,65	225x91x34
LT-35 12V PRO	32.000mAh	12V	6h	600A	1500A		Gasolina/Diesel todos	5V 2,1A; 5V 3A; 9V 2A; 12V 1,5A; 15V 10A	2,6	266x251x102
LT-56 12/24V PRO	56.000mAh	12/24V	10h	1000A	2000A		Gasolina/Diesel todos	5V 2,1A; 5V 3A; 9V 2A; 12V 1,5A; 15V 10A	2,8	260x188x149

CARREGADOR EVMOU-16

Ref. ST10302



€ 199.00



Corrente de entrada	230V - 1ph
Corrente de carregamento nominal selecionável	10A / 16A
Ligações	Shuko - Type 2
Extensão	Cabo entrada 1,5 m Cabo saída 4 m
Índice de proteção	IP66
Temperatura de funcionamento	-40°C / +50°C
Normas	IEC 61851 - IEC 62752
Proteção fugas	IAn 30mA 6mA

CABOS CBMOU-16/32

Ref. ST10303



€ 150.00



Ligações	Type 2 - Type 2
Extensão	5 m
Corrente	16A / 32A
Índice de proteção	IP54
Material do cabo	TPU

CABOS DE ARRANQUE

CU 16 mm

3 m | 220 A
Ref. ST06014

€ 53.00



CU 25 mm

3,5 m | 350 A
Ref. ST06015

€ 85.00



CU 35 mm

4,5 m | 480 A
Ref. ST06016

€ 130.00



PINÇAS

1 Pinça de bateria negra 600A
Ref. ST10205

€ 2.75

2 Pinça de bateria vermelha 600A
Ref. ST10206

€ 2.75

3 Conjuntos pinças bateria 75 A
Ref. ST06018

€ 4.00

4 Conjuntos pinças bateria 200A
Ref. 06017

€ 13.70



PROTECTOR DE PICOS

Protetor de picos para soldadura 12/24V
Ref. ST10156

€ 61.00



GERADORES SOLARES



A SOLTER dedica-se há mais de 30 anos à gestão da energia. Com as novas estações de energia ASTRO, disporá de energia limpa para tudo o que necessitar.

- LIMPA
- SILENCIOSA
- FÁCIL DE USAR

Abastecimento de energia em caso de emergência

Utilize os dispositivos ASTRO como fontes de energia de emergência. Com até 2200 W de potência, se ficar sem abastecimento elétrico, poderá utilizar todos os dispositivos de sua casa.



Tecnologia bidirecional, utilize o seu gerador enquanto o carrega



Portas para todos os dispositivos



3 métodos de carregamento, fonte ilimitada de energia.

Poderá carregar o seu dispositivo ASTRO ligado a 230 V, mediante os painéis solares SP ou mesmo ligado aos 12 V do seu carro. Para uma experiência realmente ilimitada.

GERADORES SOLARES

ASTRO

**ASTRO
600**

**ASTRO
1200**

**ASTRO
2200**

€670.00

€1150.00

€1850.00



Bateria	560 Wh
Saída AC 230V contínua	600W / Sinus wave
Saídas	230V / 12V / USB
Tempo de carregamento 0-100%	AC 230V > 5,5 - 6,6h Solar (PS-100x1) > 8 - 10h Coche 12V > 7,5 - 8,5h
Dimensões	290x165x230 mm
Peso	5,5 kg

Bateria	1132Wh
Saída AC 230V contínua	1200W / Sinus wave
Saídas	230V / 12V / USB
Tempo de carregamento 0-100%	AC 230V > 6,5 - 7,5 Solar (PS-200x1) > 7 - 9h Coche 12V > 11,5 - 12,5h
Dimensões	380x225x260 mm
Peso	10,9 kg

Bateria	2131Wh
Saída AC 230V contínua	2200W / Sinus wave
Saídas	230V / 12V / USB
Tempo de carregamento 0-100%	AC 230V > 9 - 10h Solar (PS-200x2) > 7 - 8h Coche 12V > 18 - 19h
Dimensões	380x225x260 mm
Peso	16,8 kg

PAINEL SOLAR

PS 100

PS 200



€258.00



€455.00

Potência de pico	100W +/- 10%
Tipo de célula	Monocristalino
Eficiência	22%
Dimensões dobrado	398x365x70mm
Dimensões aberto	1995x396x4mm
Número de painéis	5
Voltagem de serviço (Vmp)	18V
Corrente de serviço (Imp)	5,6A
Peso	4,2Kg

Potência de pico	200W +/- 10%
Tipo de célula	Monocristalino
Eficiência	22%
Dimensões dobrado	530x530x90mm
Dimensões aberto	2920x530x4mm
Número de painéis	5
Voltagem de serviço (Vmp)	22,5V
Corrente de serviço (Imp)	8,9A
Peso	9,4Kg

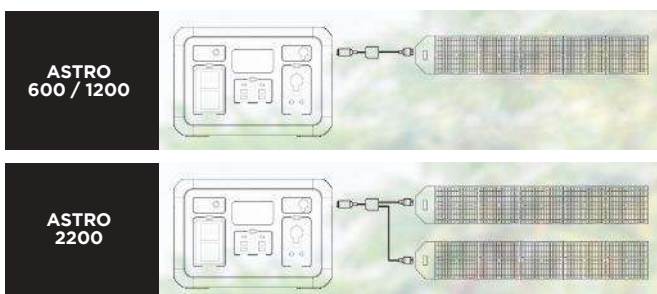

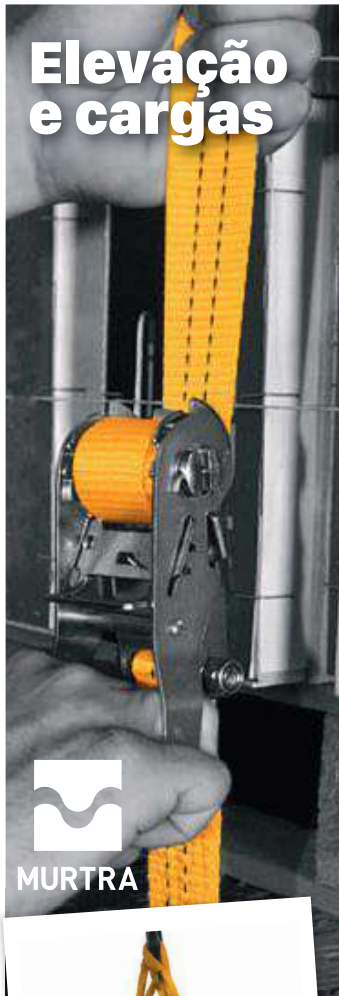

Elevação e cargas



EAD

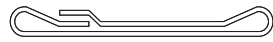

Sabia que?

► A cor da fita identifica a capacidade de carga em tração vertical (conforme EN 1942-1 e 2).

- até 1000 kg;
- até 2000 kg;
- até 3000 kg;
- até 4000 kg;
- até 5000 kg;
- até 6000 kg;
- até 8000 kg;
- até 10000 kg.

► A partir de capacidade de 10T. é sempre utilizada a cor laranja.



ZC

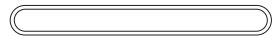

CINTAS ZC

EN 1492:2 / S.F. 7:1. Cintas tubular sem fim.

● ZC1000X1 1000 Kg / 1 Mt	€ 6.95
● ZC1000X1.5 1000 Kg / 1.5 Mt	€ 7.93
● ZC1000X2 1000 Kg / 2 Mt	€ 6.07
● ZC1000X3 1000 Kg / 3 Mt	€ 8.71
● ZC1000X4 1000 Kg / 4 Mt	€ 11.01
● ZC2000X1 2000 Kg / 1 Mt	€ 4.54
● ZC2000X1.5 2000 Kg / 1.5 Mt	€ 6.37
● ZC2000X2 2000 Kg / 2 Mt	€ 8.23
● ZC2000X3 2000 Kg / 3 Mt	€ 11.25
● ZC2000X4 2000 Kg / 4 Mt	€ 14.27
● ZC2000X6 2000 Kg / 6 Mt	€ 21.79

● ZC3000X1 3000 Kg / 1 Mt	€ 5.39
● ZC3000X2 3000 Kg / 2 Mt	€ 9.18
● ZC3000X2.5 3000 Kg / 2.5 Mt	€ 11.73
● ZC3000X3 3000 Kg / 3 Mt	€ 14.27
● ZC3000X4 3000 Kg / 4 Mt	€ 19.62
○ ZC4000X2 4000 Kg / 2 Mt	€ 14.50
○ ZC4000X3 4000 Kg / 3 Mt	€ 22.57
○ ZC4000X4 4000 Kg / 4 Mt	€ 30.13
● ZC5000X3 5000 Kg / 3 Mt	€ 31.28
● ZC5000X4 5000 Kg / 4 Mt	€ 44.05
● ZC5000X5 5000 Kg / 5 Mt	€ 55.25
● ZC5000X6 5000 Kg / 6 Mt	€ 63.98
● ZC8000X6 8000 Kg / 6 Mt	€ 84.64

CINTAS EAD

EN 1492 : 1 / S.F. 7 : 1. Cintas planas de duas camadas.

● EAD1000X1 1000 Kg / 1 Mt	€ 3.36
● EAD1000X2 1000 Kg / 2 Mt	€ 4.67
● EAD1000X3 1000 Kg / 3 Mt	€ 6.37
● EAD1000X4 1000 Kg / 4 Mt	€ 7.83
● EAD1000X6 1000 Kg / 6 Mt	€ 13.13
● EAD2000X1.5 2000 Kg / 1.5 Mt	€ 7.31
● EAD2000X2 2000 Kg / 2 Mt	€ 8.34
● EAD2000X3 2000 Kg / 3 Mt	€ 11.39
● EAD2000X4 2000 Kg / 2 Mt	€ 14.31
● EAD2000X5 2000 Kg / 5 Mt	€ 17.36
● EAD2000X6 2000 Kg / 6 Mt	€ 20.52
● EAD3000X2 3000 Kg / 2 Mt	€ 13.05
● EAD3000X3 3000 Kg / 3 Mt	€ 25.58
● EAD3000X4 3000 Kg / 4 Mt	€ 22.14
● EAD3000X5 3000 Kg / 5 Mt	€ 26.77
● EAD3000X6 3000 Kg / 6 Mt	€ 31.51

HOBBY1000-5VR

CINTA BRICO HOBBY 1000-5
● 25mm. 5 Mts. Carga Máx - 1000 Kg.



NP3500/63-9 | NP3500/63-12

CINTA NP 3500
● 50mm. 9/12 Mts. Carga máx. 3500 Kg.



PACKAMPROF-S

PACK DE CINTAS PROFISSIONAIS
2 cintas c/ gancho 35mm x 6 mt (2000 Kg) + 2 cintas com fivela 25 mm x 2.5 mt (250 Kg).



PQ1000-5BL

CINTA MINI PRO 1000
● 25mm. 5 Mts. Carga máx. 1000 Kg.



NP2000/56-6BL

CINTA MINI PRO 2000
● 35mm. 6 Mts. Carga máx. 2000 Kg.



NP5000/63-9

CINTA PRO 5000
● 50mm. 9 Mts. Carga máx. 5000 Kg. EN12195/2.



CORRENTE DE ELEVAÇÃO
5.0 / 6.3 / 7.1 / 80 mm

5.0 MM
TGCT50MM
€ 4.⁵⁵

6.3 MM
TGCE63MM
€ 19.¹¹

7.1 MM
TGCE71MM
€ 23.⁶⁶

8.0 MM
TGCE80MM
€ 27.⁵³

- ▶ Compactos e leves para facilitar a utilização.
- ▶ Componentes estruturais em aço para aumentar a força de trabalho.
- ▶ Guia da corrente de carga.
- ▶ Travão mecânico.
- ▶ Corrente de cargas pesadas.



DIFERENCIAL PULL-LIFT
0.25 / 0.5 / 0.75 / 1 / 1.5 / 3 / 6 Toneladas.

0.25 TON
TGPL025TX10M
€ 164.⁹⁴

0.5 TON
TGPL050TX10M
€ 227.⁹⁶

0.75 TON
TGPL075TX15M
€ 254.³⁵

1 TON
TGPL100TX15M
€ 270.²⁸

1.5 TON
TGPL150TX15M
€ 328.⁷⁵

3 TON
TGPL300TX15M
€ 472.³⁰

6 TON
TGPL600TX15M
€ 795.⁸¹

- ▶ Estrutura em aço. Leve, compacto e portátil.
- ▶ Resistente ao impacto.
- ▶ Rotação de 360°.
- ▶ Guia da corrente de carga.
- ▶ Guia da corrente de carga.
- ▶ Exige pouco esforço para puxar a alavanca.



DIFERENCIAIS MANUAIS
0.5 / 1 / 1.5 / 2 / 3 / 5 Toneladas.

0.5 TON
TGD05TX25M
€ 235.⁹²

1 TON
TGD10TX25M
€ 255.⁹⁴

1.5 TON
TGD15TX25M
€ 330.³⁴

2 TON
TGD20TX30M
€ 400.⁴¹

3 TON
TGD30TX30M
€ 496.⁸⁷

5 TON
TGD50TX30M
€ 799.²³

CARRO TRANSPORTE SEM TRACÇÃO
0.5 / 1 / 2 / 3 / 5 Toneladas.

0.5 TON
TGCTS05T
€ 127.⁸⁶

1 TON
TGCTS10T
€ 146.⁷⁴

2 TON
TGCTS20T
€ 219.⁵⁴

3 TON
TGCTS30T
€ 324.⁸⁸

5 TON
TGCTS50T
€ 561.²⁶



CARRO TRANSPORTE SEM TRACÇÃO
0.5 / 1 / 2 / 3 / 5 Toneladas.

0.5 TON
TGCTC05T
€ 180.⁸⁷

1 TON
TGCTC10T
€ 212.⁷²

2 TON
TGCTC20T
€ 280.⁹⁷

3 TON
TGCTC30T
€ 409.⁷⁹

5 TON
TGCTC50T
€ 685.⁰²



- ▶ Podem ser usados com guinchos manuais e elétricos.
- ▶ As rodas contêm rolamentos selados que suavizam a utilização.

- ▶ Os ganchos superior e inferior com tratamento térmico para resistir às tarefas mais rigorosas.
- ▶ Engrenagens duráveis de alta precisão.



sistema de travagem

CB

DIFERENCIAIS MANUAIS
0.5 / 1 / 1.5 / 2 / 2.5 / 3 / 5 Toneladas.
Inclui corrente de 3 Mts.

0.5 TON
CB005SSH030030
€ **405.00**

1 TON
CB010SSH030030
€ **475.00**

1.5 TON
CB015SSH030030
€ **668.00**

2 TON
CB020SSH030030
€ **883.00**

2.5 TON
CB025SSH030030
€ **996.00**

3 TON
CB030SSH030030
€ **1072.00**

5 TON
CB050SSH030035
€ **1565.00**

segurança fiável

trava de gancho

guia da corrente de carga

corrente de carga niquelada

ER2

sistema de suspensão



estrutura robusta

DIFERENCIAIS ELÉTRICOS
0.5 / 1 / 2 Toneladas.

0.5 TON
ER2005241H060S060
€ **2230.00**

1 TON
ER2010241H060S060
€ **2957.00**

2 TON
ER2020241H060S060
€ **3588.00**

comando de controlo

funcionamento suave e ergonomico

gancho de carga

- ▶ É proibido alargar a corrente de carga com elos adicionais.
- ▶ O comprimento standard do cabo de alimentação é de cinco metros.
- ▶ Para aplicações em condições extremas - potente, duradouro e robusto. Possibilidade de grandes capacidades de carga, variantes e opções.



Fotografias meramente ilustrativas.

© Para mais informações técnicas contacte o nosso serviço de apoio ao cliente.

Soluções de arrumação e armazenamento



ARMÁRIOS DE GAVETAS



● LT14414010
€ 1925.⁶³
● LT14414020
€ 1925.⁶³

● LT14413010
€ 2075.⁸⁴
● LT14413020
€ 2075.⁸⁴

● LT14249010 / ● LT14249020
€ 1018.⁷⁶

● LT78222010
€ 1246.⁶⁹
● LT78222020
€ 1246.⁶⁹

Número gavetas mm	Número de tabuleiros extensíveis	L → mm	P ↗ mm	A ↑ mm	Unidade LISTA	Fecho	Capacidade por gaveta	Art. n.º	Art. n.º
-------------------	----------------------------------	--------	--------	--------	---------------	-------	-----------------------	----------	----------

Armário de gavetas

8: 1×50 / 2×75 / 2×100 / 2×150 / 1×200	-	717	753	1020	36×36E	KEY Lock	75 kg	LT14414010	LT14414020
10: 1×50 / 2×75 / 7×100	-	717	753	1020	36×36E	KEY Lock	75 kg	LT14413010	LT14413020

Armário de gavetas móvel

com rodízios de nylon Ø100 mm, rebordo elevado e puxador

5: 4×100 / 1×200	-	564	572	890	27×27E	KEY Lock	75 kg	LT14249010	LT14249020
------------------	---	-----	-----	-----	--------	----------	-------	------------	------------

Móvel de gavetas com portas batentes e 2 gavetas

Todos os armários de gavetas com 1020 mm de altura desta página dupla estão equipados com: Rebordo com 3 lados, 20 mm de altura, incluindo tapete estriado.

2: 2×75	2	717	725	1000	36×36E	KEY Lock	75 kg	LT78222010	LT78222020
---------	---	-----	-----	------	--------	----------	-------	------------	------------

CARRINHOS DE FERRAMENTAS L3627 COM 6 GAVETAS

Cobertura	Multiplex (Espessura: 40 mm)
Número gavetas (mm)	6: 2×75 / 2×100 / 1×150 / 1×200
Unidade LISTA	36×27E
Fecho	KEY Lock
Capacidade de carga	400 kg
Capacidade de carga por gavetas	40 kg
■ Art. n.º	LT81062010
■ Art. n.º	LT81062020

capacidade de carga por gaveta 40 kg

L → 894 mm
P ↗ 525 mm
A ↑ 928 mm

● LT81062010
€ 912.⁵³
● LT81062020
€ 912.⁵³





● LT60418010
€ **683.⁸⁸**

● LT60418020
€ **683.⁸⁸**

● LT60419010
€ **933.⁸⁰**

● LT60419020
€ **933.⁸⁰**

① **Versão galvanizada (.222):**
Estão disponíveis outras cores a custo extra.



Módulo adicional
● LT50203222
€ **159.⁶³**

Estantes de base
● LT50202222
€ **217.⁰⁴**

Prateleiras reguláveis	Dobradiças	diagonal (galvanizado)	Suportes de prateleira	L → mm	P ↗ mm	A ↑ mm	Fecho	Carga por prateleira	Art. n.º	Art. n.º
Armário com 2 portas batentes										
4	Pinos de rotação	-	-	1000	400	1950	KEY Lock	60 kg	LT60418010	LT60418020
4	Pinos de rotação	-	-	1000	500	1950	KEY Lock	60 kg	LT60419010	LT60419020
Estante universal L1006										
<div style="display: flex; justify-content: space-between;"> ■ Estantes de base ■ Módulo adicional </div>										
5: com fendas, 25 mm	-	1	2	1000	500	1950	-	160 kg	LT50202222	LT50203222

POSTOS E BANCADAS DE TRABALHO



● LT40961010
€ **543.⁸⁰**

● LT40961020
€ **543.⁸⁰**



↗ *grande variedade de combinações possíveis*

● LT40970010
€ **1199.⁰⁴**

● LT40970020
€ **1199.⁰⁴**



● LT40963010
€ **686.73**
● LT40963020
€ **686.73**

a melhor organização de cada posto de trabalho



● LT40972010
€ **1271.84**
● LT40972020
€ **1271.84**

L → mm	P ↗ mm	A ↑ mm	Número gavetas mm	Tempo de bancada de trabalho	Fecho	Capacidade de carga	Art. n.º	Art. n.º
Bancada de trabalho								
1500	750	840	-	Multiplex, 40 mm	-	600 kg	● LT40961010	● LT40961020
			5: 1×50 / 2×100 / 1×150 / 1×300	Multiplex, 40 mm	KEY Lock	1500 kg	● LT40970010	● LT40970020
2000	750	840	-	Multiplex, 40 mm	-	350 kg	● LT40963010	● LT40963020
			5: 1×50 / 2×100 / 1×150 / 1×300	Multiplex, 40 mm	KEY Lock	800 kg	● LT40972010	● LT40972020



uso profissional

ideais para otimizar o espaço em áreas de produção

L → 1077 mm
P ↗ 514 mm
A ↑ 932 mm

● LT18364010
● LT18364020
€ **956.31**

● LT18365010
● LT18365020
€ **899.73**

● LT18368010
● LT18368020
€ **959.43**

UNIDADE DE TRANSPORTE NC

1 × estante frontal, incluindo tapete estriado em PVC, 1 × Quadro de inserção com par de suportes horizontais, 2 × Quadro de inserção com par de suportes oblíquos

Suportes NC	40 suportes ISO-SK 40	25 suportes ISO-SK 50	30 suportes HSK 63 A+C+E/80 B+D+F
Padrão de atribuição	B	F	E
● Art. n.º	● LT18364010	● LT18365010	● LT18368010
● Art. n.º	● LT18364020	● LT18365020	● LT18368020

ACESSÓRIOS NC

Suporte de mesa NC	Equipamento	L → mm	P ↗ mm	A ↑ mm	Art. n.º	Versão	Preço
	Quadro com 3 fileiras Versão: Chapa de aço Cor: Cinzento, NCS S 4502-B Peças laterais: Azul claro / Cinzento claro Unidade Lista: 36 × 27 E	588	413	345	● LT15431010	24 suportes ISO-SK 40	€ 237.65
					● LT15431020		€ 237.65
		● LT15432010	15 suportes ISO-SK 50	€ 190.22			
		● LT15432020		€ 190.22			
		● LT18353010	18 suportes HSK 63	€ 215.45			
		● LT18353020	A+C+E/80 B+D+F	€ 215.45			

Quadro de inserção NC para gaveta

	1 × quadro 1 × par de suportes Unidade Lista: 36 × 36 E	588	596	82-162	● LT80829000	32 suportes ISO-SK 40 Padrão de ocupação: B	€ 262.08
					● LT80830000	20 suportes ISO-SK 50 Padrão de ocupação: F	€ 219.14
					● LT80833000	24 suportes HSK 63 A+C+E/80 B+D+F Padrão de ocupação: E	€ 262.29

© PARA MAIS INFORMAÇÕES TÉCNICAS CONTACTE O NOSSO SERVIÇO DE APOIO AO CLIENTE



KOCEL[®]



KO3325-5015
BANCADA DE TRABALHO
Dimensões 1700x700x850 mm. Ral 5015 revestido a pó eletrostático. Inclui prateleira fixa topo MDF 25 mm.

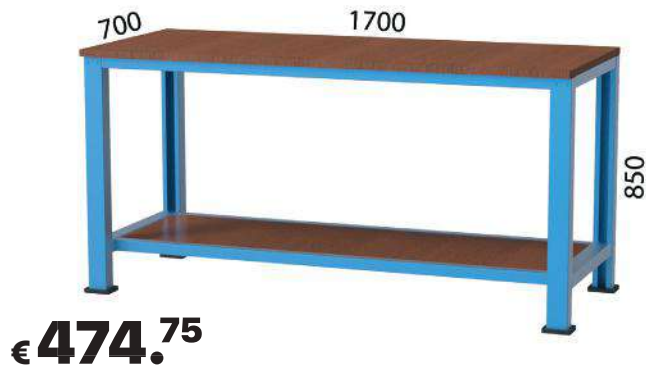

KO3220-5015
BANCADA DE TRABALHO COM 6 GAVETAS
Dimensões 2000x700x850 mm. Ral 5015 revestido a pó eletrostático. Inclui prateleira fixa. 5+1 gavetas topo MDF 25 mm revestido a PVC.

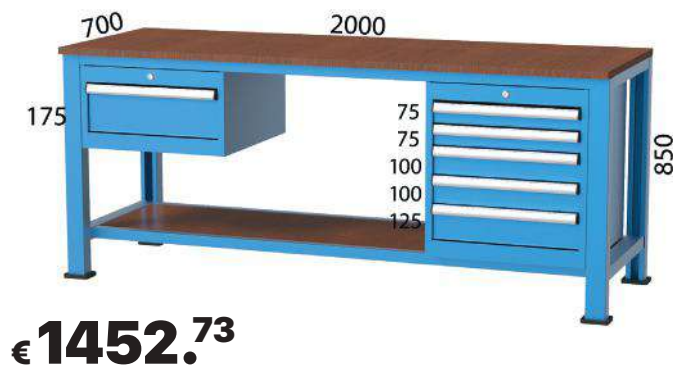

KO8026-5015
BANCADA DE TRABALHO MÓVEL
Dimensões 1120x570x945mm. Ral 5015 revestido a pó eletrostático. Inclui 2 prateleiras fixas.



KO8021-5015
BANCADA DE TRABALHO MÓVEL
Dimensões 1120x570x960 mm. Ral 5015 revestido a pó eletrostático. Alt. gaveta variável 75-200 mm. 80 Kg.



KO8023-5015
BANCADA DE TRABALHO MÓVEL
Dimensões 1120x570x920 mm. Ral 5015 revestido a pó eletrostático. Alt. gaveta variável 75-200 mm. 80 kg.



**KO8047-5015
BANCADA DE TRABALHO MÓVEL**

Dimensões 600x450x1550 mm. Ral 5015 revestido a pó eletrostático. Inclui 4 containers A150 (190x125x100mm). 80 kg.



€ **246.⁴²**

**KO7100-5015
ARMÁRIO COM 7 GAVETAS**

Dimensões 710x725x1005 mm. Ral 5015 revestido a pó eletrostático. Alt. gaveta variável 75-200mm. 80 kg.

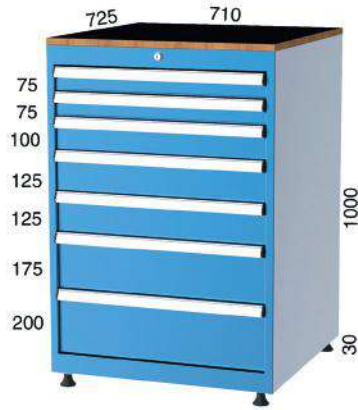

€ **877.⁷⁸**

**KO7440-5015 / KO7440-7035
ARMÁRIO PARA COMPUTADOR**

Dimensões 560x570x1700 mm. Ral 5015/7035 revestido a pó eletrostático. Recomendado para monitores até 17". Inclui gaveta para teclado.

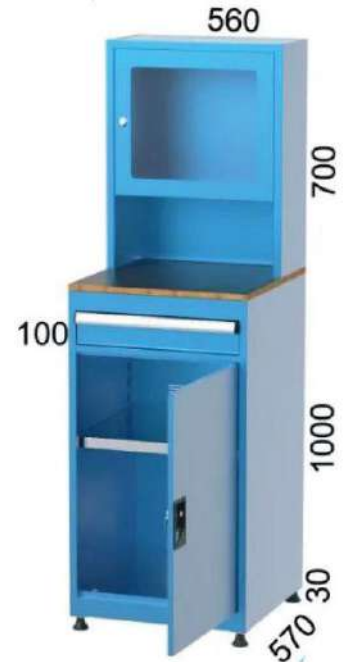

● KO7440-5015
€ **539.¹⁹**

○ KO7440-7035
€ **539.¹⁹**

**KO6233-7035
ARMÁRIO PARA ARQUIVO**

Dimensões 920x400x2000 mm. Ral 7035 revestido a pó eletrostático. Inclui 4 prateleiras.



€ **544.²⁴**

**KO7455-1028
ARMÁRIO PARA MATERIAIS QUÍMICOS**

Dimensões 920x450x2000 mm. Ral 1028 revestido a pó eletrostático. Inclui 5 prateleiras com aba de retenção de líquidos.



€ **970.⁴⁰**

**KO7470-1028
ARMÁRIO PARA MATERIAIS QUÍMICOS**

Dimensões 1010x615x2000mm. Ral 1028 revestido a pó eletrostático. Inclui 4 tabuleiros extensíveis com grandil+tina inferior p/ retenção de líquidos.



€ **1578.⁵⁹**

K07435-5015 / K07435-7035
ESTAÇÃO DE TRABALHO P/ COMPUTADOR

Dimensões 1010x570x1700 mm. Área Monitor 400x250x340 mm. Ral 5015 revestido a pó eletrostático. Recomendado para monitores até 17". Inclui gaveta para teclado.



● K07440-5015
 ○ K07435-7035
€ 779.¹⁶

K06032-5015
CACIFO DUPLO

Dimensões: 600x400x1850 mm. Ral 5015 revestido a pó eletrostático. Inclui 4 prateleiras. Permite uso de cadeado ou chave.



€ 339.⁹³

K06033-5015
CACIFO TRIPLO

Dimensões: 900x400x1850 mm. Ral 5015 revestido a pó eletrostático. Inclui 6 prateleiras. Permite uso de cadeado ou chave.



€ 372.⁹²

K06082-5015
ARMÁRIO COM 14 CACIFOS

Dimensões: 570x400x1825 mm. Ral 5015 revestido a pó eletrostático. Permite uso de cadeado ou chave.



€ 323.⁹⁵

K06054-5015
CACIFO DUPLO - 4 PORTAS

Dimensões: 400x800x2000 mm. Ral 5015 revestido a pó eletrostático. Permite uso de cadeado ou chave.



€ 229.¹⁰

K06061-5015
ARMÁRIO COM 6 CACIFOS

Dimensões: 1050x400x1010 mm. Ral 5015 revestido a pó eletrostático. Permite uso de cadeado ou chave.



€ 161.¹⁴

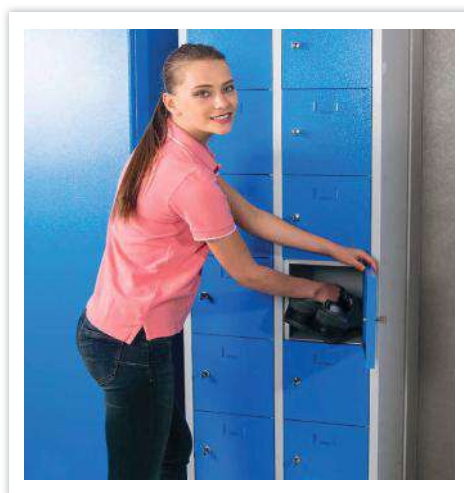

DISTRIBUÍDO POR



MSGROUP
MARQUES DOS SANTOS
www.msgroup.pt

MKT0001-PTV1

