

2022

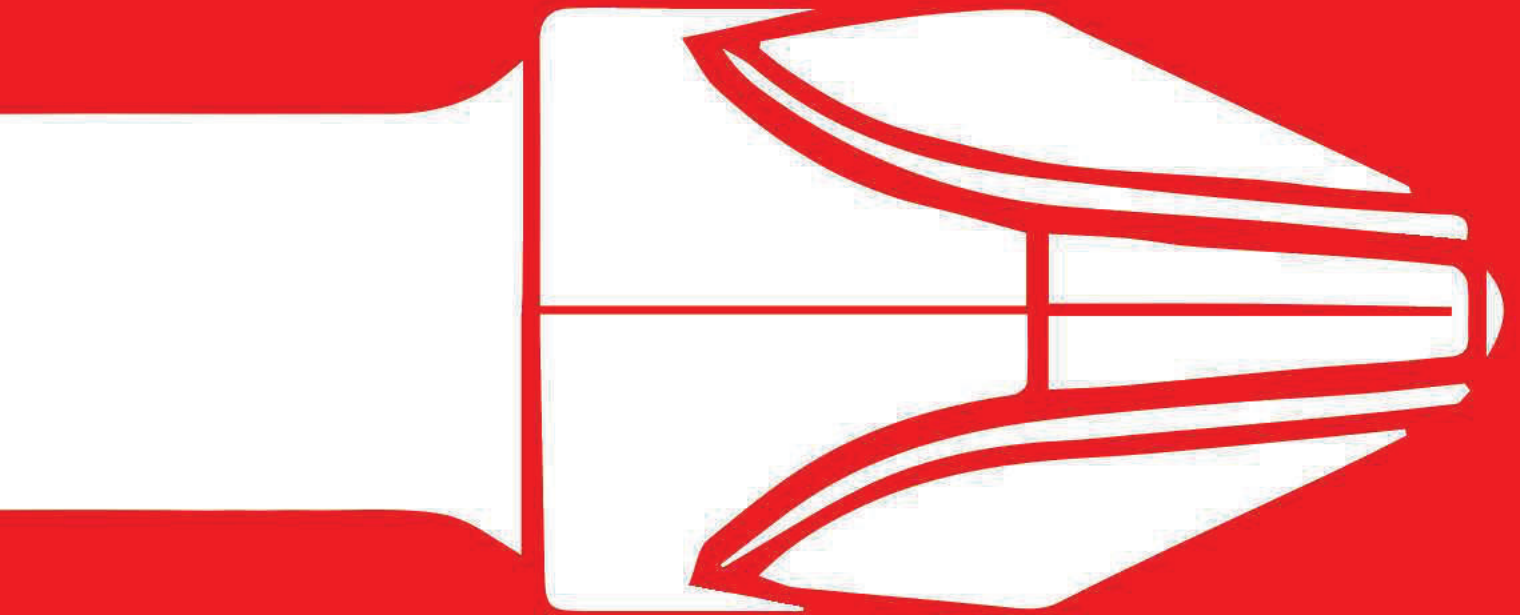

LTI[®]
SCREWDRIVING TOOLS



LINHA ESSENTIAL
ESSENTIAL LINE

12

LINHA PREMIUM
PREMIUM LINES

COLOUR+	28
MAG-BIT+™	38
PULSAR®	42
TORSION®	50
HDC	58
INX	66

28

SUPORE DE BIT'S
BIT HOLDERS

74

CABEÇOTES ANGULARES
ANGLE HEADS

82

ADAPTADORES
ADAPTERS

86

**BIT'S E CHAVES
ESPECIAIS**
SPECIAL BITS AND SETTERS

92

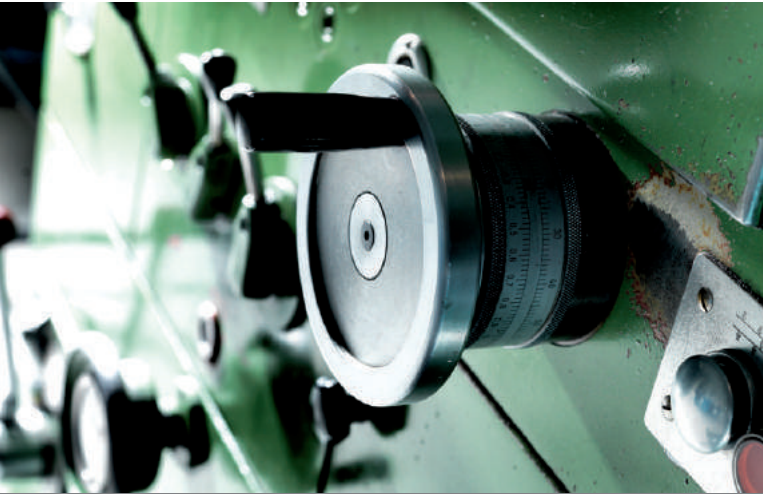

Uma das primeiras máquinas perfiladoras para chaves de fendas importadas para Itália.
One of the first milling machines for screwdrivers imported into Italy.

RESEARCH - A evolução de aparafusadoras cada vez mais potentes, a necessidade de aumentar a produtividade das linhas de montagem, a utilização de parafusos auto-formantes e auto-perfurantes mesmo em materiais extremamente duros está a levar-nos a procurar novos materiais que permitam otimizar a relação dureza/resistência e novas soluções de produção que possam oferecer um acoplamento ideal entre parafuso e ponta.

RESEARCH of more and more powerful screwdrivers, the need to increase productivity of the assembly lines, the use of self-forming and self-drilling screws even on extremely hard materials, inspires us to search for new materials that optimise the relationship between hardness and toughness and new production solutions that can offer excellent coupling between the screw and insert bit.

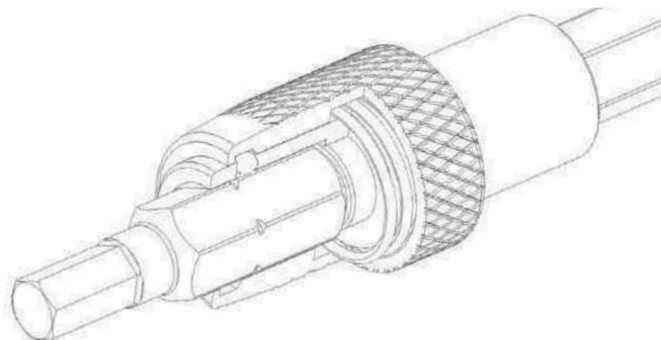

Conceção e desenvolvimento de um suporte para Bit's com um mandril de bloqueio.
Developing of a block chuck bit-holder.

EXPERIÊNCIA - Um arquivo com milhares de desenhos, inúmeros casos de resolução de problemas em linha de montagem e instalações de aparafusamento automático, colaboração com fabricantes de ferramentas de aparafusamento industrial e fabricantes de parafusos - esta é a bagagem de conhecimentos que torna a marca LTI sinónimo de qualidade e alta fiabilidade do produto.

EXPERIENCE with thousands of drawings and designs, numerous special tools made for assembly lines and automatic screwing systems, constant collaboration with tool manufacturers for industrial screwing applications, and with screw manufacturers. This wealth of knowledge makes the LTI brand synonymous with quality and high reliability.

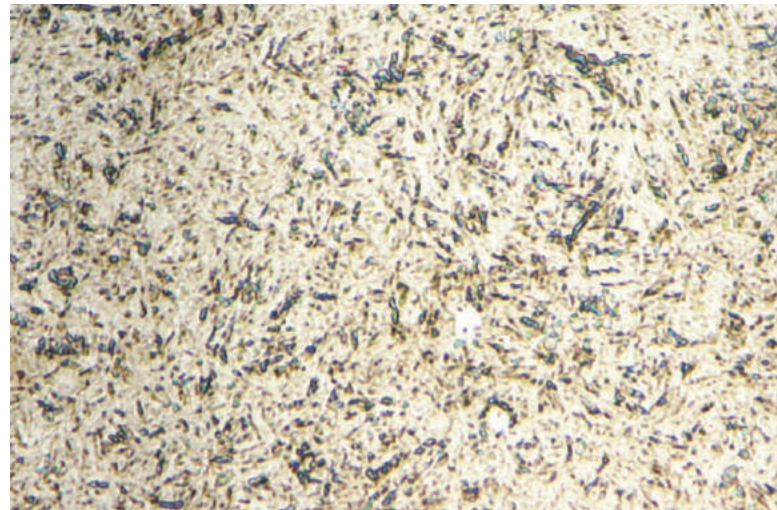

Microestrutura de aço a partir da qual são feitas as Bit's.
Enlargement of the microstructure of the steel used to produce our bits.

INOVAÇÃO - Esta é a base para a conceção e fabrico dos novos produtos que oferecemos aos mercados profissional e especializado numa grande variedade de materiais, propriedades técnicas, acabamentos e sortidos, com especial atenção às embalagens destinadas ao ponto de venda.

INNOVATION - The design and manufacture of new products for the professional and specialist market is based on innovation. For this reason, our products are available in a wide variety of materials, technical properties, finishes and assortments with new packaging dedicated to stores.



KNOW-HOW

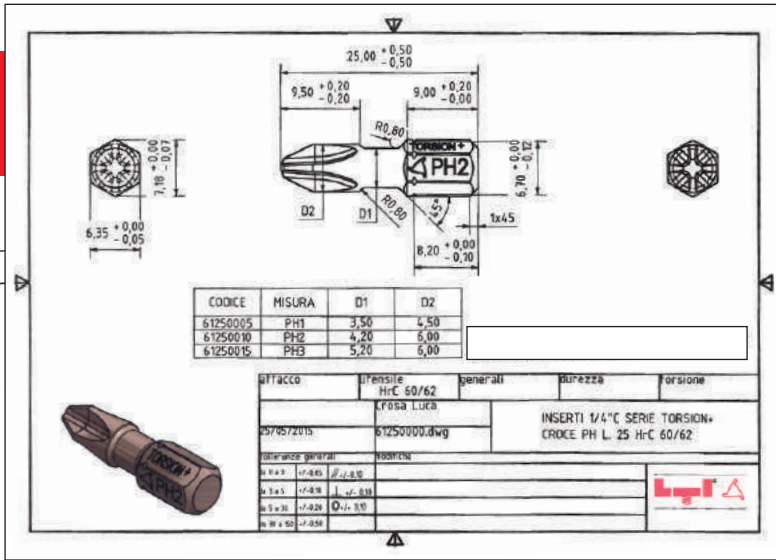

PROJETAR E DESENVOLVIMENTO DESIGN AND DEVELOP

O nosso departamento técnico é capaz de conceber a ferramenta mais adaptada às necessidades do utilizador industrial e identificar, com a ajuda do controlo de qualidade, o material e o tratamento térmico mais adequados para garantir o melhor desempenho. Desenvolvemos um novo produto a cada dois dias.

Our technical office is able to design the tool best suited to the needs of the industrial user, and to identify, with the help of the quality service, the material and heat treatment best suited to ensure the best performances. We develop a new product every two days.

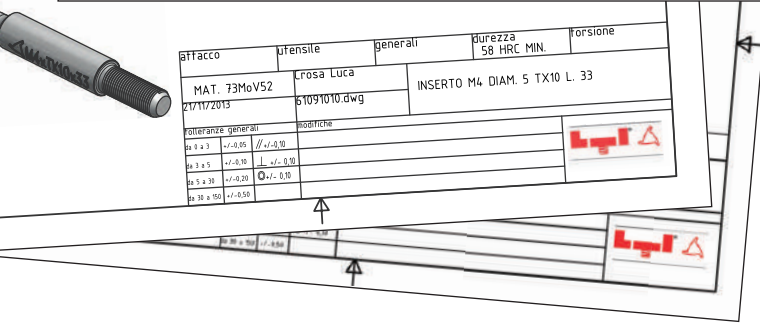

TORNEAMENTO E PERFILAGEM TURNING AND MILLING

Tornos CNC, para operações de elevada precisão, com os quais podemos trabalhar barras de 4 mm a 20 mm de diâmetro. Perfiladoras específicas para Bit's. Esta é a maquinaria que temos à nossa disposição para satisfazer as exigências dos nossos clientes.

CNC lathes for high precision machining, which allows machining bars with diameters of 4mm to 20mm. Specific forming machines for bits. We have all the machinery to cater to the needs of our customers.

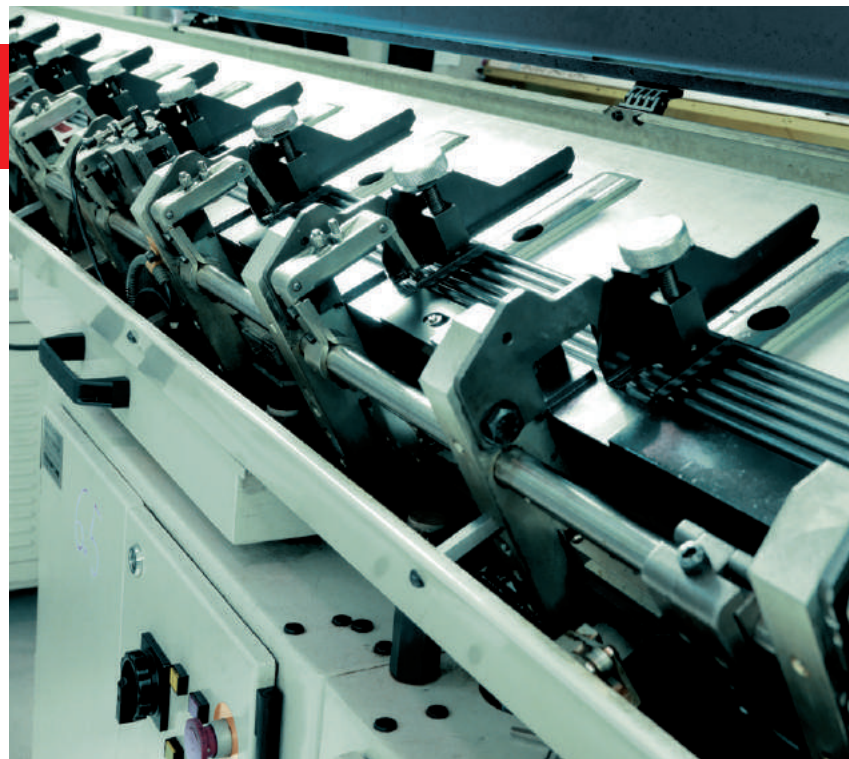

Carregador automático de barras para torno CNC.
Automatic bar loader for CNC lathe.

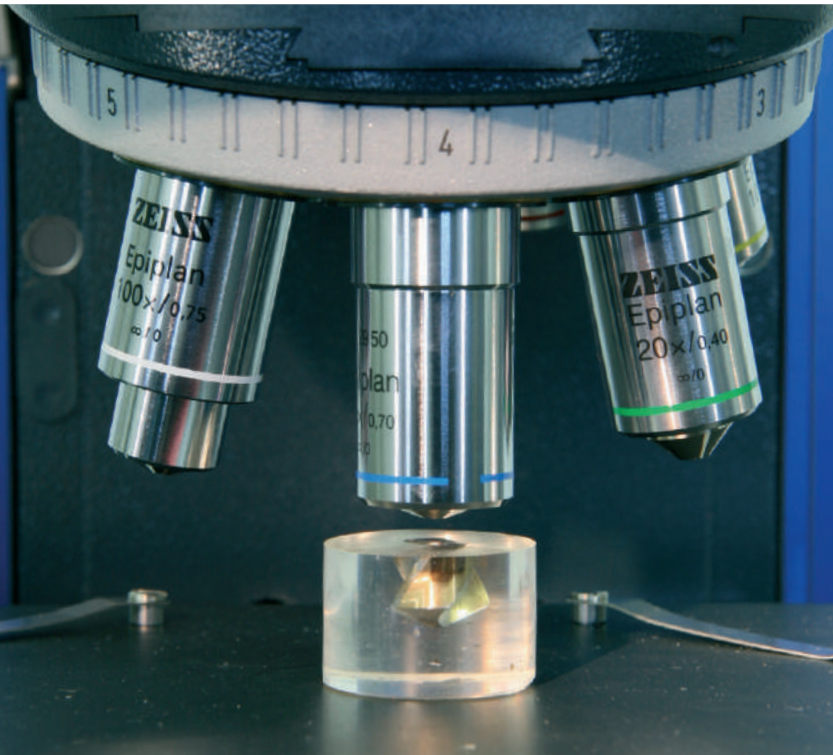

Verificação da microestrutura com microscópio eletrônico de 1000X.
Structure quality checking by microscope 1000X.

TESTE DE QUALIDADE QUALITY TEST

O laboratório de controlo de qualidade de última geração e bem equipado garante toda a produção das nossas ferramentas. Os controlos metalográficos específicos e precisos sobre o aço que compramos e o produto que temperamos garantem um elevado desempenho das nossas ferramentas em total segurança.

The ultra-modern and well-equipped control laboratory guarantees the entire production of our tools. Specific and accurate metallographic controls on the steel that we purchase and on the product that we temper, ensures high performance of our tools in the utmost safety.

TRATAMENTO TÉRMICO HEAT TREATMENT

Somos a única empresa em Itália e uma das poucas na Europa a tratar as próprias Bit's internamente com um sistema de têmpera a vácuo. Este tipo de tecnologia permite, com absoluta certeza, evitar problemas de descarburização e oxidação da superfície.

Internal heat treatment department: the only company in Italy and among the few in Europe to temper bits with a vacuum tempering plant. This type of technology prevents problems associated with oxidation and decarburisation of the surfaces.

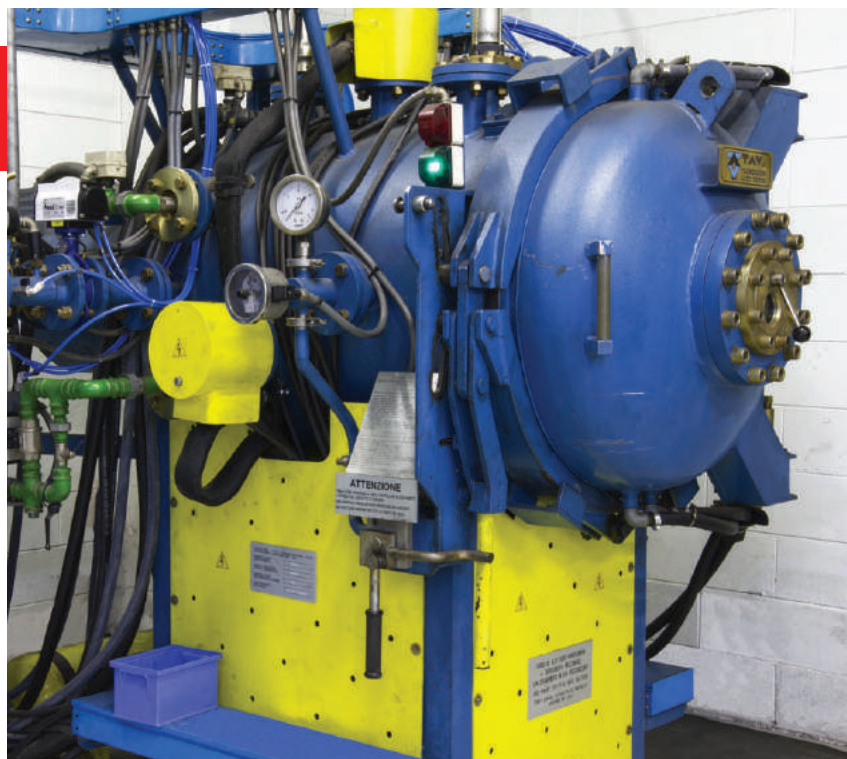

Forno de têmpera a vácuo para tratamento térmico.
Vacuum furnace for heat treatment.



ARTIGOS MEDIANTE PEDIDO

CUSTOM-MADE ITEMS

A nossa empresa produz Bit's para aparafusadoras de acordo com as normas internacionais, mas também fabrica produtos mediante pedido específico e desenho do cliente, mesmo para lotes pequenos. A experiência dos nossos técnicos auxilia a conceção e solução de qualquer necessidade particular relacionada com operações de aparafusamento em instalações automáticas. Todos os processamentos mecânicos e o tratamento térmico são realizados internamente, razão pela qual garantimos aos nossos clientes a máxima flexibilidade e um serviço personalizado ao mais alto nível para o fabrico de produtos específicos de elevada qualidade. Operamos com sucesso na indústria de grandes eletrodomésticos, linha de montagem mecânicas, estaleiros navais ou aeroespaciais; os nossos produtos respondem diariamente a grandes desafios e os nossos clientes reconhecem

o suporte constante e qualificado que lhes oferecemos.

Our company manufactures bits for drills and drivers in accordance with the international standards, as well as products to fit the exact specifications and requests of customers, including small quantities. The experience and expertise of our technicians supports the design and solution of each detail of automatic screwing operations.

The machining operations and heat treatments are all performed internally; for this reason, we are able to offer customers maximum flexibility, first-rate personalised service to create high quality and specific products. We work successfully in the field of household appliances, mechanical assembly lines, shipbuilding and aircraft production. Our products face important challenges every day and our customers recognise the constant and qualified support we offer them.



Exemplos de artigos produzidos mediante pedido.
Examples of items made on demand.

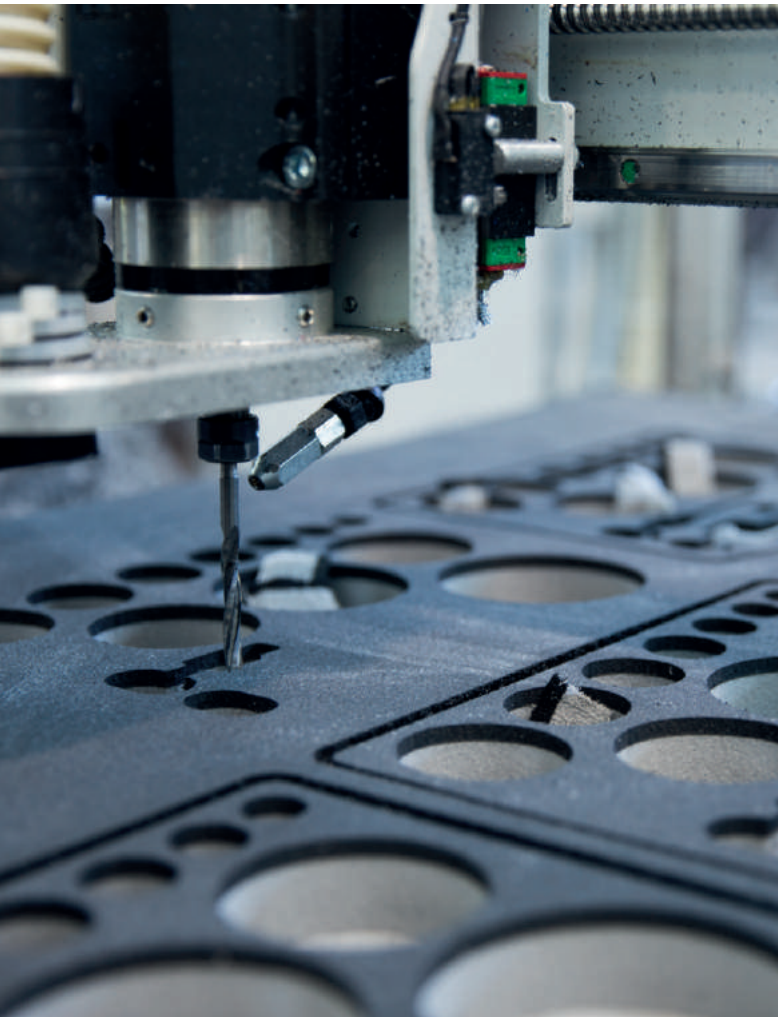

Para alcançar a excelência no apoio ao cliente, oferecemos agora a possibilidade de produzir conjuntos e estojos com conteúdos específicos: o nosso parque de máquinas foi ampliado com uma fresadora de corte de esponjas que permite realizar sedes para a inserção de ferramentas e acessórios de acordo com as necessidades do cliente.

To achieve excellence in customer service we can offer you to create sets and cases with specific contents: our machine fleet has in fact been expanded with a sponge milling machine that allows the creation of dedicated seats for the insertion of tools and accessories on customer's request.

O cliente pode personalizar o conteúdo do conjunto, escolhendo as ferramentas desejadas e decidindo a cor da esponja em que serão colocadas.

The customer can customize the contents of the set by choosing the desired tools and deciding the color of the sponge in which they will be arranged.

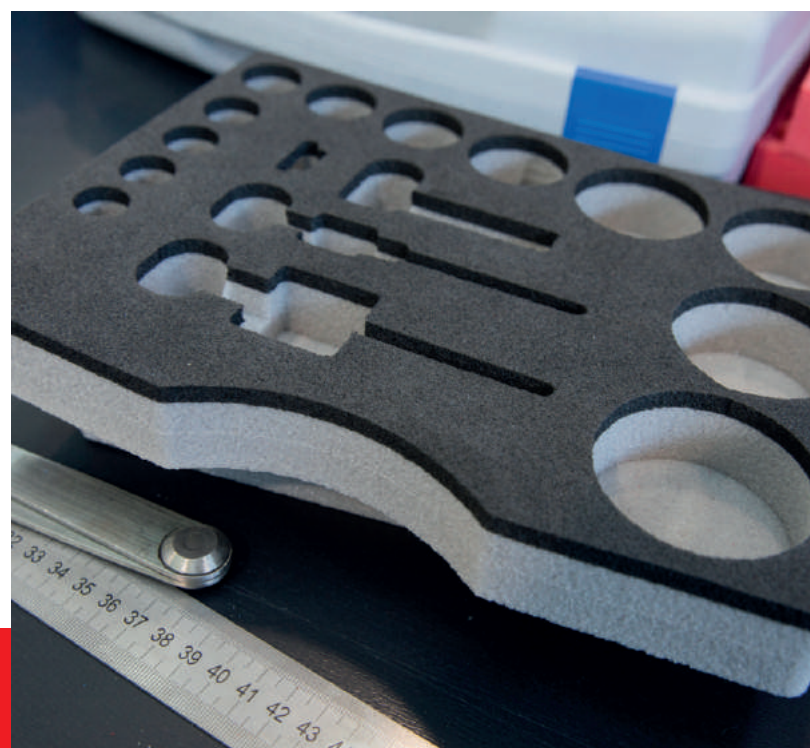



COMO UTILIZAR O CATÁLOGO

HOW TO USE THE CATALOGUE

Tópico específico
Specific topic

Indicações do capítulo
Chapter indications

Especificações do produto
Product specifications

Indicações da família do produto
Indications of the product family

Embalagem de base
Basic packaging

Outras embalagens
Other packaging



1.3 PORTAINSERTI/ADATTATORI

BIT HOLDERS/ADAPTERS
PORTE EMBOUTS/ADAPTATEURS
PORTA INSERTOS/ADAPTADORES

62013 MAGNETICI SENZA ANELLO

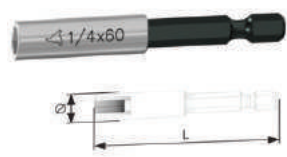

PORTAINSERTI 1/4" E PER 1/4" C MAGNETICI
1/4" E BIT-HOLDER FOR 1/4" C MAGNETIC
PORTE-EMBOUTS 1/4" E POUR 1/4" C MAGNETIQUES
PORTA PUNTIAS DE 1/4" E PARA 1/4" C MAGNETIQUES

EASYPACK | sacchetto PVC con Euro-hole • PVC bag with Euro-hole

L mm	Ø mm	PCS.	COD.	€ cod/ver
50	10	5	62013004	
60	10	5	62013005	
75	10	5	62013010	
100	10	5	62013015	
120	10	5	62013020	
150	10	5	62013025	
200	10	5	62013030	
250	10	5	62013035	

L mm	COD.	€ cod
50	62013004001	
60	62013005001	
75	62013010001	
100	62013015001	



62015 MAGNETICI CON ANELLO



PORTAINSERTI 1/4" E PER 1/4" C MAGNETICI CON ANELLO
1/4" E BIT-HOLDER FOR 1/4" C MAGNETIC WITH RING
PORTE-EMBOUTS 1/4" E POUR 1/4" C MAGNETIQUES AVEC ANNEAU
PORTA PUNTIAS DE 1/4" E PARA 1/4" C MAGNETIQUES CON ANILLO

EASYPACK | sacchetto PVC con Euro-hole • PVC bag with Euro-hole

L mm	Ø mm	PCS.	COD.	€ cod/ver
50	10	5	62015005	
60	10	5	62015010	
75	10	5	62015015	
100	10	5	62015020	
120	9,8	5	62015025	
150	10	5	62015030	
200	9,8	5	62015035	
250	11	5	62015040	
400	11	5	62015070	

L mm	COD.	€ cod
50	62015005001	
60	62015010001	
75	62015015001	
100	62015020001	



Descrição do produto
 Product description

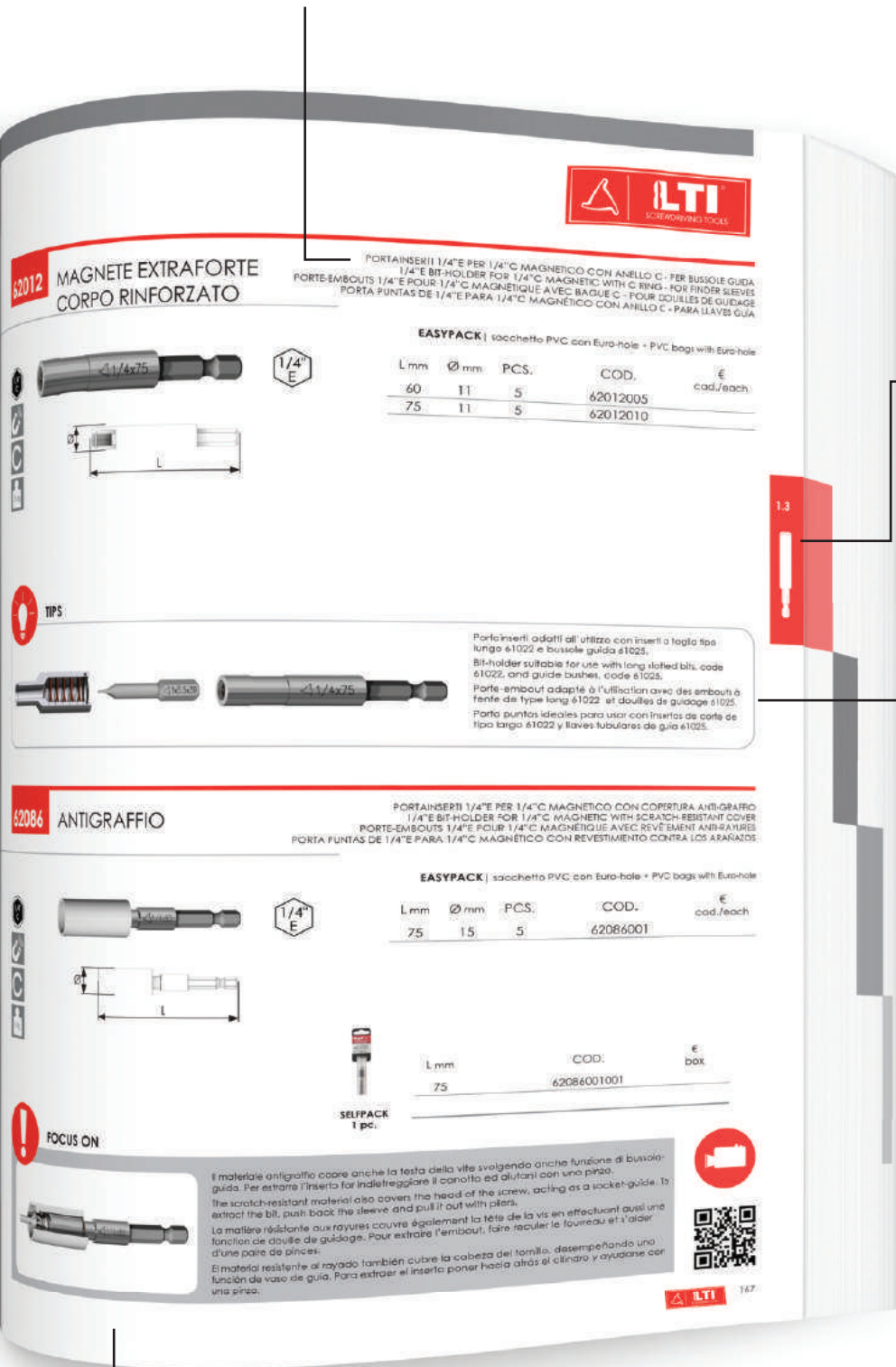

Indicações do capítulo
 Chapter indications

Informações adicionais de
 utilização
 In-depth studies

Informações adicionais -
 Características
 In-depth studies



COMO UTILIZAR O CATÁLOGO

HOW TO USE THE CATALOGUE

1 62013 MAGNETICI SENZA ANELLO 2

3 PORTAINSERTI 1/4"E PER 1/4"C MAGNETICO
1/4"E BIT-HOLDER FOR 1/4"C MAGNETIC
PORTE-EMBOUTS 1/4"E POUR 1/4"C MAGNÉTIQUE
PORTA PUNTAS DE 1/4"E PARA 1/4"C MAGNÉTICO

4 40/44 HRC

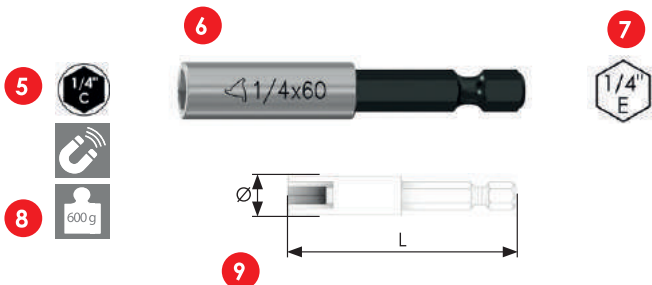

10 EASYPACK | sacchetto PVC con Euro-hole PVC bags with Euro-hole

11		12	13	14
L mm	Ø mm	PCS.	COD.	€ cad./each
50	10	5	62013004	
60	10	5	62013005	
75	10	5	62013010	
100	10	5	62013015	
120	10	5	62013020	
150	10	5	62013025	
200	10	5	62013030	
250	10	5	62013035	

11	13	16
L mm	COD.	€ box
50	62013004001	
60	62013005001	
75	62013010001	
100	62013015001	

15 SELFPACK 1 pc.

1 Indicação da família produto
Indication of the product family

2 Produto apresentado
Product presented

3 Descrição do produto
Product description

4 Características técnicas
Technical features

5 Perfil/ligação
Tip/connection

6 Imagem do produto
Product image

7 Engate
Attachment

8 Especificações do produto
Product specifications

9 Desenho técnico
Technical design

10 Embalagem de base
Basic packaging

11 Medidas específicas
Specific measurements

12 Quantidade mínima de compra
Minimum amount of purchase

13 Código do produto
Product Code

14 Preço unitário
Unit price

15 Outras embalagens
Other packaging

16 Preço por embalagem
Price per pack

LAB TEST



Arquivo multimédia criado em colaboração com o laboratório de análise e controlo de qualidade: conceção e produção, testes comparativos e aplicações práticas.

Multimedia archive created in collaboration with the analysis and quality control laboratory: design and creation, comparative tests and practical applications.



FOCUS ON

Informações específicas por produto: características, indicações técnicas e curiosidades.

Specific studies for product characteristics, technical specifications and peculiarities.



TIPS

Conselhos de utilização e sugestões para tirar o máximo partido dos nossos produtos, nas condições mais vantajosas.

our products, in the most favourable conditions.

Tips and suggestions on how to best use

ESSENTIAL

LINHA ESSENTIAL

Essential lines

Processamentos mecânicos realizados com máquinas CNC modernas e altamente fiáveis para conferir às geometrias da ponta a precisão necessária para o melhor acoplamento com o parafuso.

Mechanical processes performed with modern CNC machines to give the geometries of the bit the precision necessary for better screw coupling.

Aço de alta qualidade com cromo-molibdênio-vanádio temperado. Temperatura de têmpera calibrada para dar a cada tipo a dureza ideal.

High-quality chrome-molybdenum-vanadium hardened steel and recovery temperature calibrated to strengthen each insert bit to its maximum hardness.



A fosfatação de zinco como revestimento de superfície confere a esta linha de produtos uma excelente resistência à oxidação.

Zinc phosphate as a surface coating offers this product line excellent oxidation resistance.



Os controlos de qualidade e a orientação para a satisfação do cliente permitem-nos manter a qualidade dos nossos produtos sempre ao mais alto nível.

Strict quality controls and constant attention to customer satisfaction ensure that the quality of our products is always at the highest levels.



Graças ao excelente equilíbrio entre dureza e resistência, as nossas Bit's ESSENTIAL não apresentam qualquer risco de rutura precoce e perigosa.

The perfect balance between hardness and toughness of our ESSENTIAL bits, prevent premature and dangerous breakage.

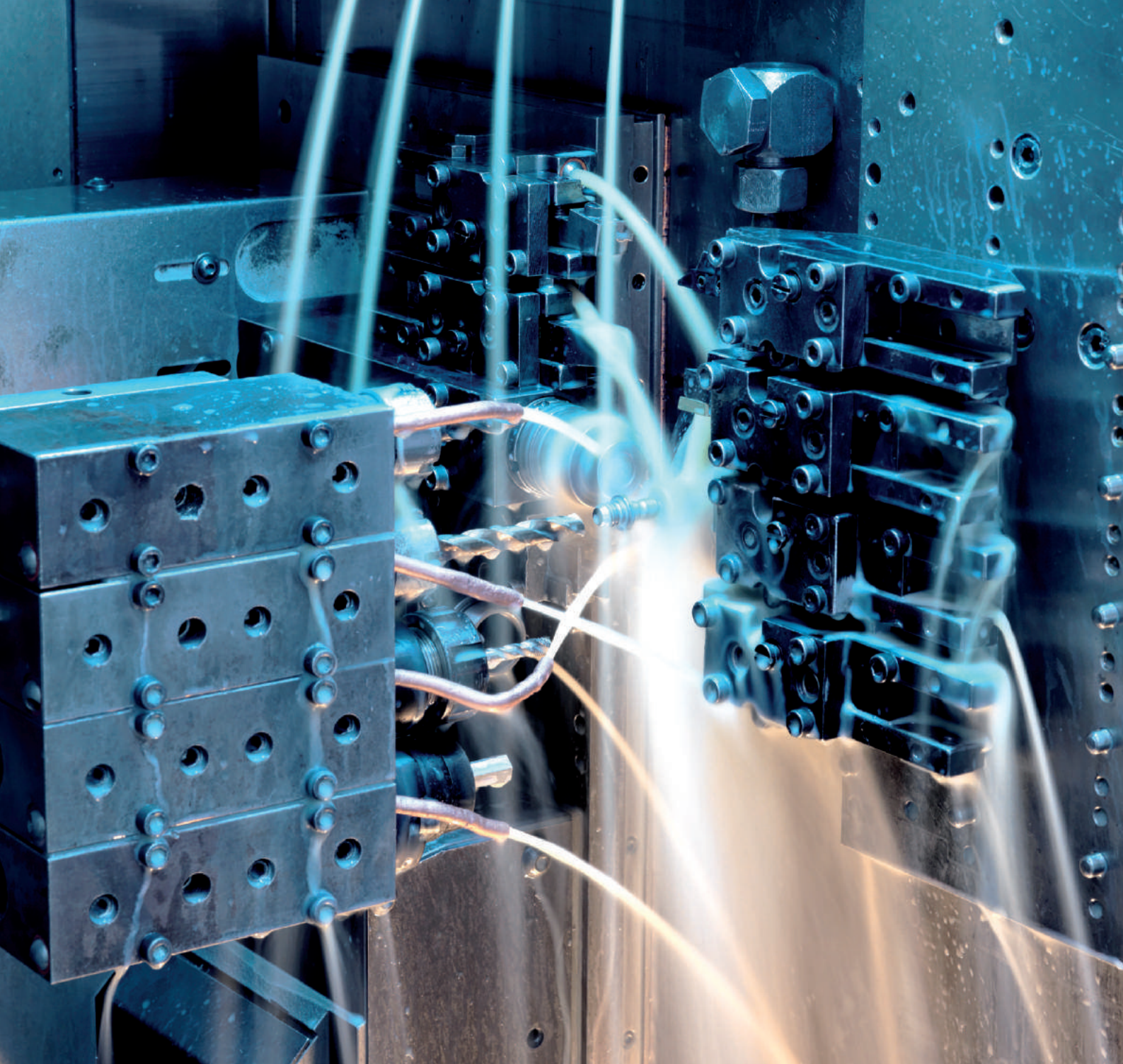

*Detalhe de uma das nossas máquinas-ferramentas: torno CN com 10 eixos de alta precisão.
One of our machine tools: CN lathe with 10 high-precision axes.*



LINHA ESSENTIAL

ESSENTIAL LINES

61043

PH FRESADAS

BIT'S 1/4" C PHILLIPS® CABEÇA FRESADA
1/4" C PHILLIPS® BITS MILLED TIP

58/60 HRC

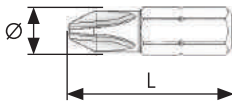

MINIBOX
10 un.

EASYPACK | caixa PVC com Euro-hole #PVC bags with Euro-hole

	L mm	CÓD.	€ box
PH0	25	61043005010	
PH1	25	61043010010	
PH2	25	61043020010	
PH3	25	61043030010	
PH4	32	61043040010	

61051

PH FRESADAS

BIT'S 1/4" E PHILLIPS® CABEÇA FRESADA
1/4" E PHILLIPS® POWER BITS MILLED TIP

58/60 HRC

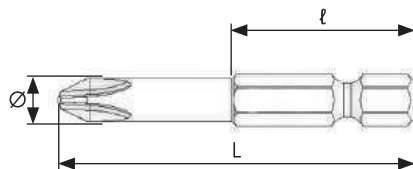

MINIBOX
5 un.

EASYPACK | caixa PVC com Euro-hole #PVC bags with Euro-hole

	L mm	ℓ mm	Ø mm	UN.	CÓD.	€ box
PH0	50	25	3	5	61051005005	
	75	25	3	5	61051010005	
	100	25	3	5	61051015005	
PH1	50	25	4,5	5	61051020005	
	70	25	4,5	5	61051024005	
	75	25	4,5	5	61051030005	
	90	25	4,5	5	61051034005	
	100	25	4,5	5	61051035005	
PH2	127	25	4,5	5	61051037005	
	150	25	4,5	5	61051040005	
	200	25	4,5	5	61051178005	
	50	25	6	5	61051045005	
	70	25	6	5	61051055005	
	75	25	6	5	61051060005	
	90	25	6	5	61051065005	
PH3	100	25	6	5	61051070005	
	120	25	6	5	61051075005	
	127	25	6	5	61051077005	
	150	25	6	5	61051080005	
PH4	200	25	6	5	61051315005	
	50	25	6	5	61051085005	
PH3	75	25	6	5	61051090005	
	100	25	6	5	61051095005	
PH4	50	25	10	5	61051105005	



61069 PZ FRESADAS

BIT'S 1/4" C POZIDRIV® CABEÇA FRESADA
1/4" C POZIDRIV® BITS MILLED TIP

58/60 HRC



MINIBOX
10 un.

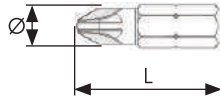

EASYPACK | caixa PVC com Euro-hole #PVC bags with Euro-hole

	L mm	CÓD.	€ box
PZ0	25	61069005010	
PZ1	25	61069010010	
PZ2	25	61069020010	
PZ3	25	61069030010	
PZ4	32	61069040010	

61076 PZ FRESADAS

BIT'S 1/4" E POZIDRIV® CABEÇA FRESADA
1/4" E POZIDRIV® POWER BITS MILLED TIP

58/60 HRC



MINIBOX
5 un.

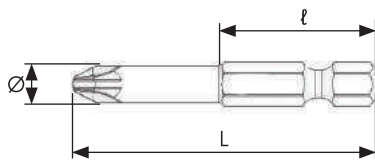

EASYPACK | caixa PVC com Euro-hole #PVC bags with Euro-hole

	L mm	ℓ mm	Ø mm	UN.	CÓD.	€ box
PZ0	50	25	3	5	61076005005	
	50	25	4,5	5	61076010005	
	70	25	4,5	5	61076019005	
	75	25	4,5	5	61076020005	
	90	25	4,5	5	61076024005	
PZ1	100	25	4,5	5	61076025005	
	127	25	4,5	5	61076085005	
	150	25	4,5	5	61076030005	
	200	25	4,5	5	61076033005	
	50	25	6	5	61076035005	
PZ2	70	25	6	5	61076044005	
	75	25	6	5	61076045005	
	90	25	6	5	61076049005	
	100	25	6	5	61076050005	
	127	25	6	5	61076054005	
PZ3	150	25	6	5	61076055005	
	200	25	6	5	61076057005	
	50	25	6	5	61076060005	
	75	25	6	5	61076065005	
	100	25	6	5	61076070005	
PZ4	50	25	10	5	61076075005	



LINHA ESSENCIAL

ESSENTIAL LINES

61094 TX

BIT'S 1/4" C PARA PARAFUSOS TORX®
1/4" C BITS FOR TORX® SCREWS

58/60 HRC

EASYPACK | caixa PVC com Euro-hole PVC bags with Euro-hole

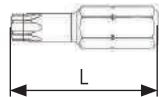

MINIBOX
10 un.

	L mm	CÓD.	€ box
TX06	25	61094005010	
TX07	25	61094010010	
TX08	25	61094015010	
TX09	25	61094020010	
TX10	25	61094025010	
TX15	25	61094030010	
TX20	25	61094035010	
TX25	25	61094040010	
TX27	25	61094045010	
TX30	25	61094050010	
TX40	25	61094055010	

61097 TX

BIT'S 1/4" E PARA PARAFUSOS TORX®
1/4" E POWER BITS FOR TORX® SCREWS

58/60 HRC

EASYPACK | caixa PVC com Euro-hole PVC bags with Euro-hole

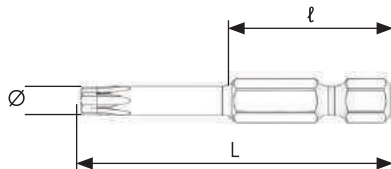

MINIBOX
5 un.

	L mm	l mm	Ø mm	UN.	CÓD.	€ box
TX05	50	25	3	5	61097005005	
	50	25	3	5	61097010005	
TX06	70	25	3	5	61097012005	
	100	25	3	5	61097014005	
TX07	150	25	3	5	61097165005	
	50	25	3	5	61097015005	
TX08	70	25	3	5	61097017005	
	50	25	3	5	61097020005	
TX09	70	25	3	5	61097130005	
	100	25	3	5	61097133005	
TX10	150	25	3	5	61097170005	
	50	25	3	5	61097025005	
TX15	50	25	4	5	61097030005	
	70	25	4	5	61097035005	
TX20	90	25	4	5	61097039005	
	100	25	4	5	61097040005	
TX25	127	25	4	5	61097043005	
	150	25	4	5	61097160005	
TX30	200	25	5	5	61097205005	
	50	25	4	5	61097045005	
TX40	70	25	4	5	61097050005	
	90	25	4	5	61097054005	
TX05	100	25	4	5	61097055005	
	127	25	4	5	61097058005	
TX06	150	25	4	5	61097135005	
	200	25	5	5	61097210005	

	L mm	l mm	Ø mm	UN.	CÓD.	€ box
TX20	50	25	4,5	5	61097060005	
	70	25	5	5	61097065005	
	90	25	5	5	61097069005	
	100	25	5	5	61097070005	
TX25	127	25	5	5	61097073005	
	150	25	5	5	61097140005	
	200	25	5	5	61097215005	
	50	25	5	5	61097075005	
TX27	70	25	5	5	61097080005	
	90	25	5	5	61097084005	
	100	25	5	5	61097085005	
	127	25	5	5	61097088005	
TX30	150	25	5	5	61097145005	
	200	25	5	5	61097220005	
	50	25	6	5	61097090005	
	70	25	6	5	61097095005	
TX30	90	25	6	5	61097099005	
	100	25	6	5	61097100005	
	127	25	6	5	61097102005	
	50	25	6	5	61097105005	
TX40	70	25	6	5	61097110005	
	90	25	6	5	61097114005	
	100	25	6	5	61097115005	
	127	25	6	5	61097118005	
TX40	150	25	6	5	61097150005	
	50	25	1/4	5	61097120005	
	70	25	1/4	5	61097125005	
	90	25	1/4	5	61097127005	
TX40	100	25	1/4	5	61097126005	
	150	25	1/4	5	61097128005	



61111 TXH COM ORIFÍCIO

BIT'S 1/4"C PARA PARAFUSOS TORX® ANTI-ADULTERAÇÃO
1/4"C BITS FOR TORX® SCREWS TAMPER-RESISTANT

58/60 HRC

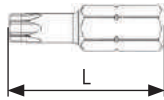

MINIBOX
10 un.

EASYPACK | caixa PVC com Euro-hole PVC bags with Euro-hole

	L mm	CÓD.	€ box
TXH09	25	61111005010	
TXH10	25	61111010010	
TXH15	25	61111015010	
TXH20	25	61111020010	
TXH25	25	61111025010	
TXH27	25	61111030010	
TXH30	25	61111035010	
TXH40	25	61111040010	

61113 TXH COM ORIFÍCIO

BIT'S 1/4"E PARA PARAFUSOS TORX® ANTI-ADULTERAÇÃO
1/4"E POWER BITS FOR TORX® SCREWS TAMPER-RESISTANT

58/60 HRC

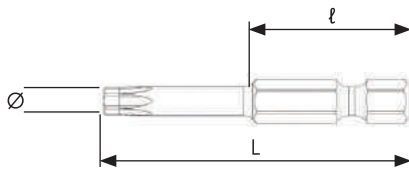

MINIBOX
5 un.

EASYPACK | caixa PVC com Euro-hole PVC bags with Euro-hole

	L mm	l mm	Ø mm	UN.	CÓD.	€ box
TXH10	50	25	4	5	61113005005	
	75	25	4	5	61113050005	
	100	25	4	5	61113055005	
	150	25	4	5	61113060005	
TXH15	50	25	4	5	61113010005	
	75	25	4	5	61113070005	
	100	25	4	5	61113075005	
TXH20	150	25	4	5	61113080005	
	50	25	4,5	5	61113015005	
	75	25	4,5	5	61113090005	
TXH25	100	25	4,5	5	61113095005	
	150	25	4,5	5	61113100005	
	50	25	5	5	61113020005	
TXH27	75	25	5	5	61113110005	
	100	25	5	5	61113115005	
	50	25	5,5	5	61113025005	
TXH30	75	25	5,5	5	61113120005	
	100	25	5,5	5	61113125005	
	50	25	6	5	61113030005	
TXH40	75	25	6	5	61113130005	
	100	25	6	5	61113135005	
	50	25	1/4	5	61113035005	
	75	25	1/4	5	61113140005	



FOCUS ON



Os parafusos com perfil THX anti-adulteração são frequentemente utilizados para a montagem de pequenos eletrodomésticos para excluir o risco de adulteração por pessoal não qualificado.

Screws with tamper-proof THX tip are often used in the assembly of small household appliances to eliminate the risk of tampering by unqualified people.

Los tornillos con huella THX anti manipulación se usan a menudo para el ensamblaje de pequeños electrodomésticos con el fin de evitar el riesgo de que sean manipulados por personal no especializado.

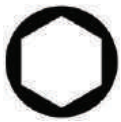

LINHA ESSENCIAL

ESSENTIAL LINES

61001 SEXTAVADO

BIT'S 1/4"C SEXTAVADAS
1/4"C HEXAGONAL BITS

58/60 HRC

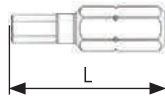

MINIBOX
10 un.

EASYPACK | caixa PVC com Euro-hole PVC bags with Euro-hole

Ø	L mm	CÓD.	€ box
1,5	25	61001005010	
2	25	61001010010	
2,5	25	61001015010	
3	25	61001020010	
4	25	61001025010	
5	25	61001030010	
6	25	61001035010	
8	25	61001045010	
10	25	61001050010	

61006 SEXTAVADO

BIT'S 1/4"E SEXTAVADAS
1/4"E HEXAGONAL POWER BITS

58/60 HRC

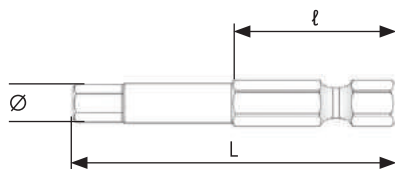

MINIBOX
5 un.

EASYPACK | caixa PVC com Euro-hole PVC bags with Euro-hole

Ø	L mm	ℓ mm	Ø mm	UN.	CÓD.	€ box
1,5	50	25	3	5	61006100005	
	70	25	3	5	61006105005	
2	50	25	3	5	61006005005	
	70	25	3	5	61006010005	
2,5	50	25	3	5	61006015005	
	70	25	4	5	61006020005	
	100	25	4	5	61006025005	
3	150	25	4	5	61006115005	
	50	25	4	5	61006030005	
	70	25	4	5	61006035005	
4	100	25	4	5	61006040005	
	127	25	4	5	61006120005	
	150	25	4	5	61006125005	
5	50	25	5	5	61006045005	
	70	25	5	5	61006050005	
	100	25	5	5	61006055005	
6	127	25	5	5	61006130005	
	150	25	5	5	61006135005	

Ø	L mm	ℓ mm	Ø mm	UN.	CÓD.	€ box
5	50	25	6	5	61006060005	
	70	25	6	5	61006065005	
6	100	25	6	5	61006070005	
	127	25	6	5	61006150005	
	150	25	6	5	61006155005	
7	50	25	1/4	5	61006075005	
	70	25	1/4	5	61006080005	
8	100	25	1/4	5	61006085005	
	127	25	1/4	5	61006165005	
	150	25	1/4	5	61006170005	
9	50	25	8	5	61006185005	
	70	25	8	5	61006190005	
10	50	25	5/16	5	61006090005	
	70	25	5/16	5	61006095005	
11	50	25	10	5	61006200005	
	70	25	10	5	61006205005	



61021 FENDA

BIT'S 1/4" C DE FENDA
1/4" C SLOTTED BITS

57/60 HRC

EASYPACK | caixa PVC com Euro-hole PVC bags with Euro-hole

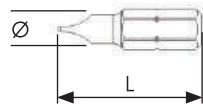

MINIBOX
10 un.

Ø mm	L mm	CÓD.	€ box
0,5	3	25	61021005010
0,6	3,5	25	61021010010
0,6	4	25	61021015010
0,6	4,5	25	61021020010
0,8	5	25	61021025010
0,8	5,5	25	61021035010
1,2	6,5	25	61021045010
1,2	8	25	61021050010
1,6	8	25	61021054010

61133 QUADRADO

BIT'S 1/4" C PERFIL QUADRADO
1/4" C BITS SQUARE TIP

58/60 HRC

EASYPACK | caixa PVC com Euro-hole PVC bags with Euro-hole



UN.	L mm	A	B	UN.	CÓD.	€ box
1	25	2,31	2,5	10	61133005005	
2	25	2,85	3,2	10	61133010005	
3	25	3,37	3,7	10	61133015005	

63004 CHAVES DE CAIXA MAGNÉTICAS

CHAVES DE CAIXA MAGNÉTICAS 1/4" E
1/4" E MAGNETIC NUT SETTERS

48/50 HRC

EASYPACK | caixa PVC com Euro-hole PVC bags with Euro-hole

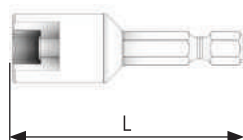

UN.	L mm	Ø mm	UN.	CÓD.	€ box
5	45	10	5	63004005002	
5,5	45	10	5	63004010002	
6	45	11	5	63004015002	
7	45	12,5	5	63004020002	
	65	12,5	5	63004025002	
8	45	12,5	5	63004030002	
	65	12,5	5	63004035002	
10	45	14,5	5	63004040002	
	65	14,5	5	63004045002	
11	45	16	5	63004050002	
12	45	18	5	63004055002	
13	45	18,5	5	63004060002	
	65	18,5	5	63004065002	
17	50	24	5	63004100002	



LINHA ESSENTIAL

ESSENTIAL LINES

66002

MYBIT 7 JOGO ESSENTIAL

CONJUNTO 7 UN. - BIT'S + SUPORTE DE BIT'S
7 UN. SET - BITS + BIT-HOLDER

CÓD. **66002105**

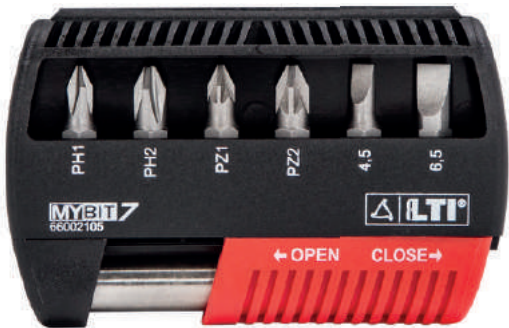

7
un.

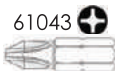

PH1
1 un.

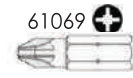

PH2
1 un.



PZ1 | PZ2
1 un. | 1 un.

0,6x4,5
1 un.

1,2x6,5
1 un.

CÓD. **66002115**

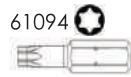

TX10
1 un.

TX15
1 un.

TX20
1 un.

TX25
1 un.

TX30
1 un.

TX40
1 un.



100 X 120 mm



INCLUÍDO / INCLU-
DED

CÓD. 62013005002



66002

DISPLAY MYBIT 7 ESSENTIAL

EXPOSITOR DE BANCADA EM ACRÍLICO PARA 12
CONJUNTOS DE BIT'S
12 UN. BIT-SETS PLEXIGLASS COUNTER DISPLAY

CÓD. **66002108**

12
un.



12 un.
CÓD. 66002105

CÓD. **66002118**



12 un.
CÓD. 66002115



150 X 40 X 195 mm



66007 MYBIT 7 POWER ESSENTIAL

CONJUNTO 7 UN. - BIT'S
7 UN. SET - BITS

NEW!

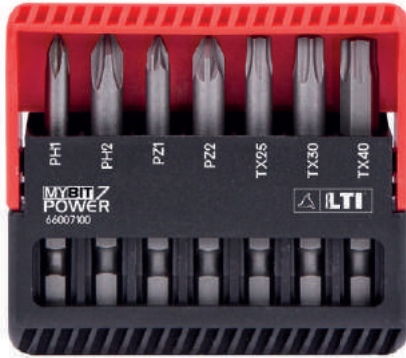

7 un.

CÓD. **66007100**

61051 L=50mm		61076 L=50mm		61079 L=50mm		
PH1 1 un.	PH2 1 un.	PZ1 1 un.	PZ2 1 un.	TX25 1 un.	TX30 1 un.	TX40 1 un.



100 X 120 mm



66005 MYBIT 10 JOGO ESSENTIAL

CONJUNTO 10 UN. - BIT'S + SUPORTE DE BIT'S
10 UN. SET - BITS + BIT-HOLDER



10 un.

CÓD. **66005105**

61043			61069			61021		
PH1 1 un.	PH2 1 un.	PH3 1 un.	PZ1 1 un.	PZ2 1 un.	PZ3 1 un.	0,6x4,5 1 un.	1,0x5,5 1 un.	1,2x6,5 1 un.



100 X 120 mm



CÓD. **66005115**

61043			61069			61094		
PH1 1 un.	PH2 1 un.	PH3 1 un.	PZ1 1 un.	PZ2 1 un.	PZ3 1 un.	TX25 1 un.	TX30 1 un.	TX40 1 un.

INCLUIDO / INCLUIDED
CÓD. 62013005002





LINHA ESSENTIAL

ESSENTIAL LINES

66005 DISPLAY MYBIT 10 ESSENTIAL

EXPOSITOR DE BANCADA EM ACRÍLICO PARA 12 CONJUNTOS DE BIT'S
12 UN. BIT-SETS PLEXIGLASS COUNTER DISPLAY

CÓD. **66005109**

12 un.



150 X 40 X 195 mm

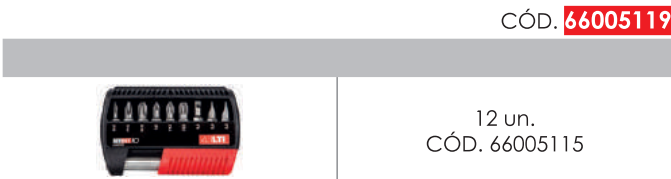

66006 MYBIT 15 JOGO ESSENTIAL

CONJUNTO 15 UN. - BIT'S + SUPORTE DE BIT'S
15 UN. SET - BITS + BIT-HOLDER

CÓD. **66006020**

15 un.



<p>61043 </p> <p>PH1 PH2 PH3 1 un. 1 un. 1 un.</p>			<p>61069 </p> <p>PZ1 PZ2 PZ3 1 un. 1 un. 1 un.</p>			<p>61021 </p> <p>0,6x4,5 0,8x5,5 1,2x6,5 1 un. 1 un. 1 un.</p>		
<p>61094 </p> <p>TX15 TX20 TX25 1 un. 1 un. 1 un.</p>			<p>61051 </p> <p>PH2x70 1 un.</p>			<p>61076 </p> <p>PZ2x70 1 un.</p>		

INCLUÍDO / INCLUDED

CÓD. 62013005002



66006 DISPLAY MYBIT 15 ESSENTIAL

EXPOSITOR DE BANCADA EM ACRÍLICO PARA 12 CONJUNTOS DE BIT'S 12 UN. BIT-SETS PLEXIGLASS COUNTER DISPLAY



12 un.

CÓD. 66006024



12 un.
CÓD. 66006020

185 X 40 X 195 mm

66006 MYBIT 14 ESSENTIAL COM CHAVE ROQUETE

CONJUNTO 14 UN. - BIT'S + SUPORTE DE BIT'S E CHAVE ROQUETE 14 UN. SET - BITS + BIT HOLDER AND RATCHET

NEW!



14 un.

CÓD. 66006500

61043			61069		
PH1 1 un.	PH2 1 un.	PH3 1 un.	PZ1 1 un.	PZ2 1 un.	PZ3 1 un.
61021			61094		
4,5x0,6 1 un.	5,5x0,8 1 un.	6,5x1,2 1 un.	TX25 1 un.	TX30 1 un.	TX40 1 un.



100 X 170 mm



INCLUÍDO / INCLUDED

CÓD. 62013005002

CÓD. 64221030



LINHA ESSENTIAL

ESSENTIAL LINES

66009 JOGO BIT'S 1/4" + SUPORTE DE BIT'S DESENGATE RÁPIDO

SORTIDO 32 UN. BIT'S COM SUPORTE DE BIT'S DE DESENGATE RÁPIDO
32 UN. BITS AND QUICK RELEASE BIT HOLDER SET



32 un.

CÓD. 66009005

PH1 2 un.	PH2 3 un.	PH3 1 un.	PZ1 2 un.	PZ2 3 un.	PZ3 1 un.
3,0x0,5 1 un.	4,5x0,6 1 un.	5,5x0,8 1 un.	6,5x1,2 1 un.	2 1 un.	2,5 1 un.
TXH09 1 un.	TXH10 1 un.	TXH15 1 un.	TXH20 1 un.	TXH25 1 un.	TXH27 1 un.
TXH30 1 un.	TXH40 1 un.				

INCLUÍDO / INCLUDED

66009 DISPLAY 6 PCS.

EXPOSITOR DE BANCADA COM 6 JOGO DE BIT'S
6 UN. BITS SETS COUNTER DISPLAY



6 un.

CÓD. 66009009

	6 un. CÓD. 66009005
--	------------------------

**63600**

JOGO CHAVES DE CAIXA MAGNÉTICAS

 CONJUNTO 6 UNIDADES CHAVES DE CAIXA MAGNÉTICAS
 6 UN. MAGNETIC NUT SETTERS SET
CÓD. **63600005****6 un.**63004 

5,5	6	7	8	10	13
1 un.	1 un.	1 un.	1 un.	1 un.	1 un.



EURO-HOLE

85 X150 mm



LINHA ESSENTIAL

ESSENTIAL LINES

66001

MULTIBOX EXPOSITOR MINIBOX

EXPOSITOR DE BANCADA EM FIO METÁLICO PARA MINICAIXA
METAL WIRE COUNTER DISPLAY FOR MINIBOX

CÓD. **66001500**

560
un.



370 X 545 X 220 mm

ESTRUTURA EM FIO METÁLICO PARA BANCADA E PARA PENDURAR, ADEQUADA PARA ACOMODAR 20 TAMANHOS DIFERENTES DE BIT'S EMBALADAS EM MINICAIXAS E DOIS ACESSÓRIOS.

COUNTERTOP OR WALL-MOUNTED METAL WIRE STRUCTURE, SUITABLE FOR HOLDING BITS IN 20 DIFFERENT SIZES, MINIBOX PACKED AND TWO ACCESSORIES.

STRUCTURE EN FIL MÉTALLIQUE DE COMPTOIR ET À SUSPENDRE, ADAPTÉE POUR 20 TAILLES DIFFÉRENTES D'EMBOUS EMBALLÉS DANS UNE MINI-BOÎTE ET DEUX ARTICLES ACCESSOIRES.

ESTRUTURA DE HILO METÁLICO PARA MOSTRADOR QUE SE PUEDE COLGAR APTA PARA ALOJAR 20 DIFERENTES MEDIDAS DE PUNTAS PUESTOS EN MINICAJAS MÁS DOS ARTÍCULOS DE ACCESÓRIOS.

			L mm	CÓD.	box
10 un.		PH0	25	61043005010	4
10 un.		PH1	25	61048005010	4
10 un.		PH2	25	61048015010	4
10 un.		PH3	25	61048025010	4
10 un.		PZ1	25	61073005010	4
10 un.		PZ2	25	61073015010	4
10 un.		PZ3	25	61073025010	4
10 un.		TX15	25	61094030010	3
10 un.		TX20	25	61094035010	3
10 un.		TX25	25	61094040010	3
10 un.		TX30	25	61094050010	3
10 un.		TX40	25	61094055010	3
10 un.		0,6x4,5	25	61021020010	3
10 un.		1,2x6,5	25	61021045010	3
5 un.		PH1	50	61056030005	2
5 un.		PH2	50	61056035005	2
5 un.		PH3	50	61056040005	2
5 un.		PZ1	50	61082030005	2
5 un.		PZ2	50	61082035005	2
5 un.		PZ3	50	61082040005	2
1 un.				62015010001	6
1 un.				62029005	4



A utilização das Bit's MAG-Bit+ permite trabalhar só com uma mão.
The use of MAG-Bit+ bits allows you to work with a free hand.



BIT'S 1/4" DE TORÇÃO COM ANEL COLORIDO

1/4" colored ring torsion bits



Gravação a laser da medida

Laser marking of size



Aplicações
applications

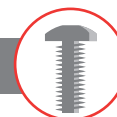
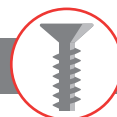

Anel pintado resistente ao óleo e aos solventes para suportar qualquer condição de trabalho.

Oil and solvents resistant painted ring to withstand any working condition.



O design exclusivo permite distribuir o esforço de torção ao longo de toda a ferramenta.

The exclusive design allows distributing the torsional stress along the entire length of the tool.



Gama completa dos tamanhos mais pedidos e utilizados no mercado, em dois comprimentos diferentes.

Full range of the most requested and used sizes on the market in two different lengths.



61450 PH COLOUR+

BIT'S 1/4" C PHILLIPS® COM CÓDIGO DE CORES
1/4" C PHILLIPS® BITS WITH COLORED CODE

NEW!

58/60 HRC

EASYPACK | caixa PVC com Euro-hole PVC bags with Euro-hole



MINIBOX
10 un.

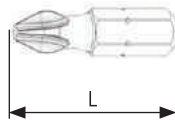

	L mm	CÓD.	€ box
PH1	25	61450005010	
PH2	25	61450010010	
PH3	25	61450015010	

61451 PH COLOUR+

BIT'S 1/4" E PHILLIPS® COM CÓDIGO DE CORES
1/4" E PHILLIPS® POWER BITS WITH COLORED CODE

NEW!

58/60 HRC

EASYPACK | caixa PVC com Euro-hole PVC bags with Euro-hole



MINIBOX
5 un.

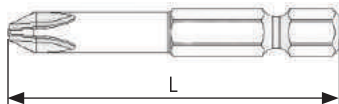

	L mm	CÓD.	€ box
PH1	50	61451005005	
PH2	50	61451010005	
PH3	50	61451015005	

61460 PZ COLOUR+

BIT'S 1/4" C POZIDRIV® COM CÓDIGO DE CORES
1/4" C POZIDRIV® BITS WITH COLORED CODE

NEW!

58/60 HRC

EASYPACK | caixa PVC com Euro-hole PVC bags with Euro-hole



MINIBOX
10 un.

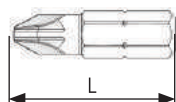

	L mm	CÓD.	€ box
PZ1	25	61460005010	
PZ2	25	61460010010	
PZ3	25	61460015010	



LINHA PREMIUM

PREMIUM LINES

61461 PZ COLOUR+

BIT'S 1/4"E POZIDRIV® COM CÓDIGO DE CORES
1/4"E POZIDRIV® POWER BITS WITH COLORED CODE

58/60 HRC

NEW!



MINIBOX
5 un.

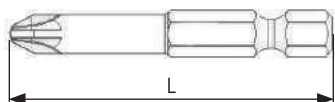

EASYPACK | caixa PVC com Euro-hole PVC bags with Euro-hole

	L mm	CÓD.	€ box
PZ1	50	61461005005	
PZ2	50	61461010005	
PZ3	50	61461015005	

61470 TX COLOUR+

BIT'S 1/4"C PARA PARAFUSOS TORX® COM CÓDIGO DE CORES
1/4"C BITS FOR TORX® SCREWS WITH COLORED CODE

58/60 HRC

NEW!



MINIBOX
10 un.

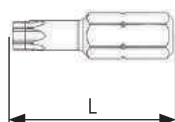

EASYPACK | caixa PVC com Euro-hole PVC bags with Euro-hole

	L mm	CÓD.	€ box
TX10	25	61470005010	
TX15	25	61470010010	
TX20	25	61470015010	
TX25	25	61470020010	
TX27	25	61470025010	
TX30	25	61470030010	
TX40	25	61470035010	

61471 TX COLOUR+

BIT'S 1/4"E PARA PARAFUSOS TORX® COM CÓDIGO DE CORES
1/4"E POWER BITS FOR TORX® SCREWS WITH COLORED CODE

58/60 HRC

NEW!



MINIBOX
5 un.

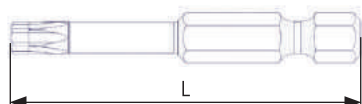

EASYPACK | caixa PVC com Euro-hole PVC bags with Euro-hole

	L mm	CÓD.	€ box
TX10	50	61471005005	
TX15	50	61471010005	
TX20	50	61471015005	
TX25	50	61471020005	
TX27	50	61471025005	
TX30	50	61471030005	
TX40	50	61471035005	



63011

CHAVES DE CAIXA IMPACT MAGNÉTICAS

CHAVES DE CAIXA 1/4"E COM ÍMAN FLUTUANTE PARA APARAFUSADORAS DE IMPACTO
1/4"E NUT SETTERS WITH FLOATING MAGNET FOR IMPACT WRENCHES

56/58 HRC

EASYPACK | caixa PVC com Euro-hole PVC bags with Euro-hole



	L mm	Ø mm	UN.	CÓD.	€ box
7	65	11	5	63011010002	
8	65	12,5	5	63011015002	
10	65	15	5	63011025002	
13	65	18,5	5	63011040002	



FOCUS ON

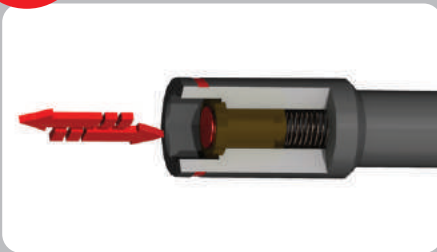

Fabricadas em aço especial com cromo-silício-vanádio, apresentam dureza e resistência à torção muito elevadas.

Made of special chrome-silicon-vanadium steel, they are very hard and extremely resistant to twisting.

66002

MYBIT 7 JOGO COLOUR+

CONJUNTO 7 UN. - BIT'S + SUPORTE DE BIT'S
7 UN. SET - BITS + BIT HOLDER

NEW!

CÓD. **66002430**



7
un.



PH1
1 un.

PH2
1 un.

PH3
1 un.



PZ1
1 un.

PZ2
1 un.

PZ3
1 un.



100 X 120 mm



INCLUÍDO / INCLUDED

CÓD. 62013005002





LINHA PREMIUM

PREMIUM LINES

66002

DISPLAY MYBIT 7 COLOUR+

EXPOSITOR DE BANCADA EM ACRÍLICO PARA 12 CONJUNTOS DE BIT'S
12 UN. BIT-SETS PLEXIGLASS COUNTER DISPLAY

NEW!



12
un.

CÓD. **66002434**



12 un.
CÓD. 66002430

150 X 40 X 195 mm

66007

MYBIT 7 POWER JOGO COLOUR+

CONJUNTO 7 UN. - BIT'S
7 UN. SET - BITS

NEW!

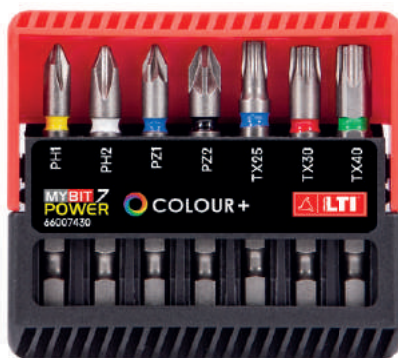

7
un.

CÓD. **66007430**

61451	⊕ L=50mm	61461	⊕ L=50mm	61471	⊕ L=50mm
PH1	PH2	PZ1	PZ2	TX25	TX30
1 un.	1 un.	1 un.	1 un.	1 un.	1 un.



100 X 120 mm



66005

MYBIT 10 JOGO COLOUR+

CONJUNTO 10 UN. - BIT'S + SUPORTE DE BIT'S
10 UN. SET - BITS + BIT HOLDER

NEW!



10 un.

CÓD. **66005430**

61450			61460			61470		
PH1	PH2	PH3	PZ1	PZ2	PZ3	TX25	TX30	TX40
1 un.	1 un.	1 un.	1 un.	1 un.	1 un.	1 un.	1 un.	1 un.



100 X 120 mm



INCLUÍDO / INCLUDED

CÓD. 62013005002



66005

DISPLAY MYBIT 10 COLOUR+

EXPOSITOR DE BANCADA EM ACRÍLICO PARA 12 CONJUNTOS DE BIT'S
12 UN. BIT-SETS PLEXIGLASS COUNTER DISPLAY

NEW!



12 un.

CÓD. **66005434**



12 un.
CÓD. 66005430

150 X 40 X 195 mm



LINHA PREMIUM

PREMIUM LINES

66006

MYBIT 15 JOGO COLOUR+

CONJUNTO 15 UN. - BIT'S + SUPORTE DE BIT'S
15 UN. SET - BITS + BIT-HOLDER

NEW!

CÓD. **66006030**

15
un.

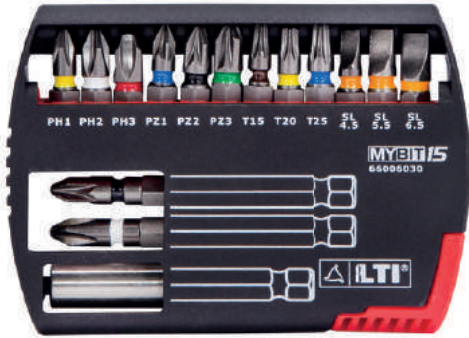

100 X 167 mm



INCLUÍDO / INCLUDED



CÓD. 62013005002



61450			61460		
PH1 1 un.	PH2 1 un.	PH3 1 un.	PZ1 1 un.	PZ2 1 un.	PZ3 1 un.
61470					
TX15 1 un.	TX20 1 un.	TX25 1 un.	4,5x0,6 1 un.	5,0x0,8 1 un.	6,5x1,2 1 un.
61451			61461		
PH2 1 un.			PZ2 1 un.		

66006

DISPLAY MYBIT 15 COLOUR+

EXPOSITOR DE BANCADA EM ACRÍLICO PARA 12 CONJUNTOS DE BIT'S
12 UN. BIT-SETS PLEXIGLASS COUNTER DISPLAY

NEW!

CÓD. **66006034**

12
un.



185 X 40 X 195 mm



12 un.
CÓD. 66006030



66006 **MYBIT 14**
COLOUR+ COM CHAVE ROQUETE

CONJUNTO 14 UN. COLOUR+ / CHAVE ROQUETE
14 UN. SET - BITS + BIT HOLDER AND RATCHET

NEW!

14 un.



CÓD. **66006530**

61450			61460		
PH1	PH2	PH3	PZ1	PZ2	PZ3
1 un.	1 un.	1 un.	1 un.	1 un.	1 un.

61470					
TX10	TX15	TX20	TX25	TX30	TX40
1 un.	1 un.	1 un.	1 un.	1 un.	1 un.



100 X 170 mm



INCLUÍDO / INCLUDED

CÓD. 62013005002

CÓD. 64221030

66009 JOGO BIT'S COLOUR 1/4"
+ SUPORTE DE BIT'S DESENGATE RÁPIDO

CONJUNTO 32 UN. BIT'S COM SUPORTE DE BIT'S
DE DESENGATE RÁPIDO
32 UN. BITS AND QUICK RELEASE BIT HOLDER SET



32 un.



CÓD. **66009015**

PH1	PH2	PH3	PZ1	PZ2	PZ3	1,3x0,5	4,5x0,6	5,5x0,8	6,5x1,2
1 un.	2 un.	1 un.	1 un.	2 un.	1 un.	1 un.	1 un.	2 un.	1 un.

3	4	5	6	TX10	TX15	TX20	TX25	TX27	TX30	TX40
1 un.	1 un.	1 un.	1 un.	1 un.	1 un.	1 un.	1 un.	1 un.	1 un.	1 un.

TXH10	TXH15	TXH20	TXH25	TXH27	TXH30	TXH40
1 un.	1 un.	1 un.	1 un.	1 un.	1 un.	1 un.

INCLUÍDO / INCLUDED



LINHA PREMIUM

PREMIUM LINES

66009

DISPLAY 6 PCS.

EXPOSITOR DE BANCADA COM 6 JOGO DE BIT'S
6 UN. BITS SETS COUNTER DISPLAY

CÓD. **66009019**



6 un.

COLOUR RING



6 un.
CÓD. 66009015

66012

JOGO BIT'S E SOQUETES 1/4" COLOUR +
CHAVES DE FENDAS DE CHAVE ROQUETE

CONJUNTO 26 UN. BIT'S, SOQUETES E ACESSÓRIOS
26 UN. BITS, SOCKETS AND ACCESSORIES

CÓD. **66012006**



26 un.

COLOUR RING



INCLUÍDO / INCLUDED



+			+		
PH1 1 un.	PH2 2 un.	PH3 1 un.	PZ1 1 un.	PZ2 2 un.	PZ3 1 un.
+			+		
1,3x0,5 1 un.	4,5x0,6 1 un.	5,5x0,8 1 un.	6,5x1,2 1 un.	TX10 1 un.	TX15 1 un.
				5 1 un.	6 1 un.
				7 1 un.	8 1 un.
				9 1 un.	10 1 un.



*Vista de um torno com controlo numérico de elevada precisão na oficina LTI.
View of a high precision CNC lathe in the LTI workshop.*

BIT'S COM SISTEMA DE RETENÇÃO MAGNÉTICA

1/4" bits with magnetic retention system

MAG-Bit+™ system

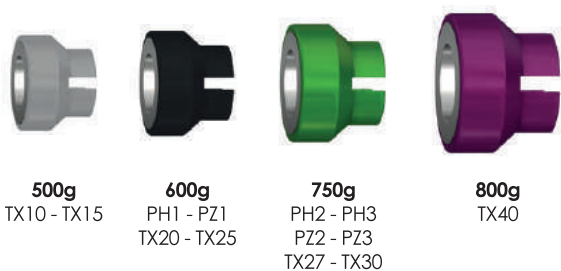

UTILIZAÇÃO

Use

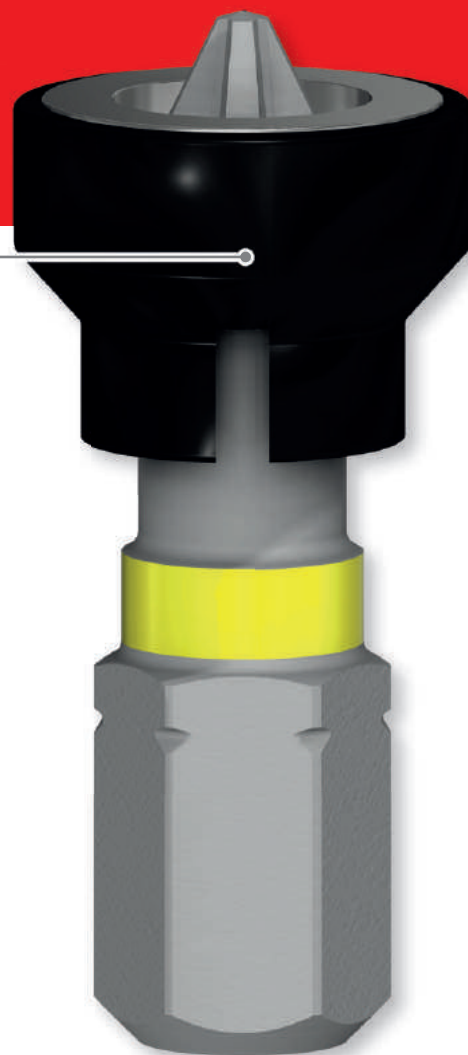
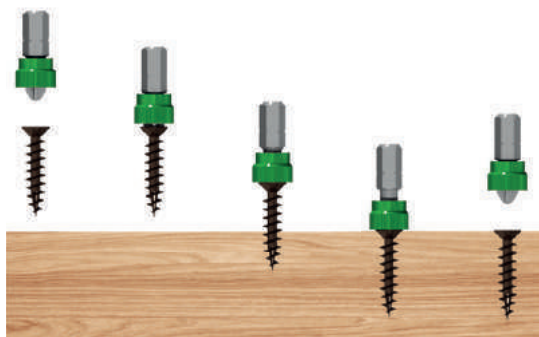

Aplicações
applications

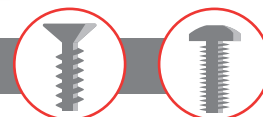

Retenção magnética em quatro formatos e capacidades diferentes para se adaptar a todos os tipos e tamanhos de parafusos.

Magnetic retention system in four different sizes and capacities to suit every type and size of screw.



Código de cores para um reconhecimento fácil e imediato tanto do tamanho, como do tipo de perfil.

COLOUR code for easy and immediate recognition of the size and profile of screw.



Sistema de retenção simples e inovador para resolver muitos problemas de aparafusamento no setor profissional.

Innovative simple retention system to solve many screwdriving problems in the professional sector.



61355 PH MAG-Bit+™

BIT'S 1/4" C PHILLIPS® COM RETENÇÃO MAGNÉTICA E CÓDIGO DE CORES
1/4" C PHILLIPS® BITS WITH MAGNETIC RETENTION AND COLORED CODE

NEW!

58/60 HRC



MINIBOX
10 un.

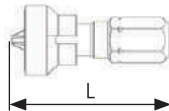

EASYPACK | caixa PVC com Euro-hole PVC bags with Euro-hole

	L mm	CÓD.	€ box
PH1	25	61355005010	
PH2	25	61355010010	
PH3	25	61355015010	

61356 PH MAG-Bit+™

BIT'S 1/4" E PHILLIPS® COM RETENÇÃO MAGNÉTICA E CÓDIGO DE CORES
1/4" E PHILLIPS® POWER BITS WITH MAGNETIC RETENTION AND COLORED CODE

NEW!

58/60 HRC



MINIBOX
5 un.

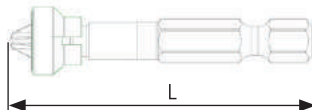

EASYPACK | caixa PVC com Euro-hole PVC bags with Euro-hole

	L mm	CÓD.	€ box
PH1	50	61356005005	
PH2	50	61356010005	
PH3	50	61356015005	

61365 PZ MAG-Bit+™

BIT'S 1/4" C POZIDRIV® COM RETENÇÃO MAGNÉTICA E CÓDIGO DE CORES
1/4" C POZIDRIV® BITS WITH MAGNETIC RETENTION AND COLORED CODE

NEW!

58/60 HRC



MINIBOX
10 un.

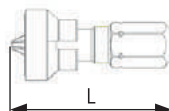

EASYPACK | caixa PVC com Euro-hole PVC bags with Euro-hole

	L mm	CÓD.	€ box
PZ1	25	61365005010	
PZ2	25	61365010010	
PZ3	25	61365015010	



LINHA PREMIUM

PREMIUM LINES

61366

PZ MAG-Bit+™

BIT'S 1/4"E POZIDRIV® COM RETENÇÃO MAGNÉTICA E CÓDIGO DE CORES
1/4"E POZIDRIV® POWER BITS WITH MAGNETIC RETENTION AND COLORED CODE

58/60 HRC

NEW!



MINIBOX
5 un.

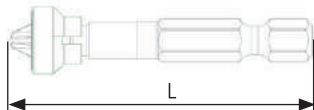

EASYPACK | caixa PVC com Euro-hole PVC bags with Euro-hole

	L mm	CÓD.	€ box
PZ1	50	61366005005	
PZ2	50	61366010005	
PZ3	50	61366015005	

61375

TX MAG-Bit+™

BIT'S 1/4"C PARA PARAFUSOS TORX® COM RETENÇÃO MAGNÉTICA E CÓDIGO DE CORES
1/4"C BITS FOR TORX® SCREWS WITH MAGNETIC RETENTION AND COLORED CODE

58/60 HRC

NEW!



MINIBOX
10 un.

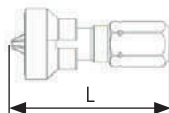

EASYPACK | caixa PVC com Euro-hole PVC bags with Euro-hole

	L mm	CÓD.	€ box
TX10	25	61375005010	
TX15	25	61375010010	
TX20	25	61375015010	
TX25	25	61375020010	
TX27	25	61375025010	
TX30	25	61375030010	
TX40	25	61375035010	

61376

TX MAG-Bit+™

BIT'S 1/4"E PARA PARAFUSOS TORX® COM RETENÇÃO MAGNÉTICA E CÓDIGO DE CORES
1/4"E POWER BITS FOR TORX® SCREWS WITH MAGNETIC RETENTION AND COLORED CODE

58/60 HRC

NEW!



MINIBOX
5 un.

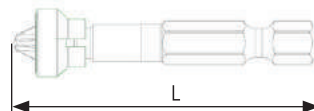

EASYPACK | caixa PVC com Euro-hole PVC bags with Euro-hole

	L mm	CÓD.	€ box
TX10	50	61376005005	
TX15	50	61376010005	
TX20	50	61376015005	
TX25	50	61376020005	
TX27	50	61376025005	
TX30	50	61376030005	
TX40	50	61376035005	



66002

MYBIT 7 JOGO MAG-Bit+™

CONJUNTO 7 UN. - BIT'S + SUPORTE DE BIT'S
7 UN. SET - BITS + BIT HOLDER

NEW!



7
un.

CÓD. 66002445

61355		61375		61375	
PH1	PH2	PZ1	PZ2	TX25	TX30
1 un.	1 un.	1 un.	1 un.	1 un.	1 un.



100 X 120 mm



INCLUÍDO / INCLUDED

CÓD. 62013005002

66002

DISPLAY MYBIT 7 MAG-Bit+™

EXPOSITOR DE BANCADA EM ACRÍLICO PARA 12 CONJUNTOS DE BIT'S
12 UN. BIT-SETS PLEXIGLASS COUNTER DISPLAY

NEW!



12
un.

CÓD. 66002449

12 un.
CÓD. 66002445

150 X 40 X 195 mm





BIT'S 1/4" PARA APARAFUSADORAS DE IMPACTO

1/4" bits for impact wrenches

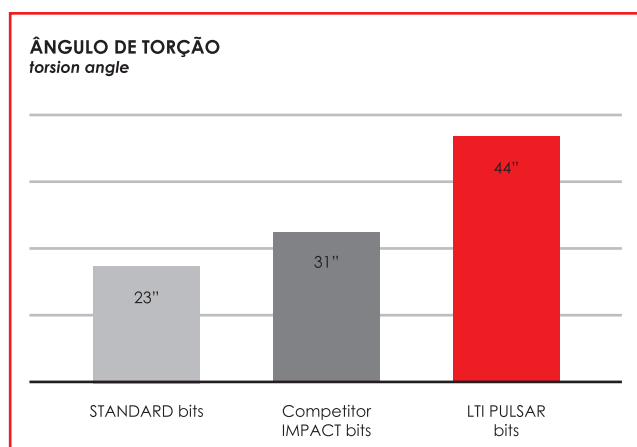
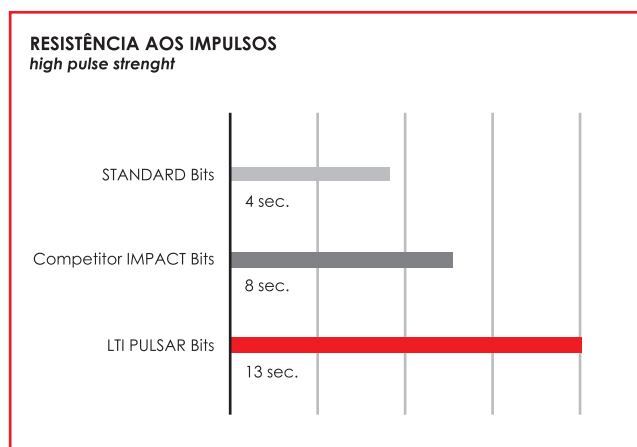
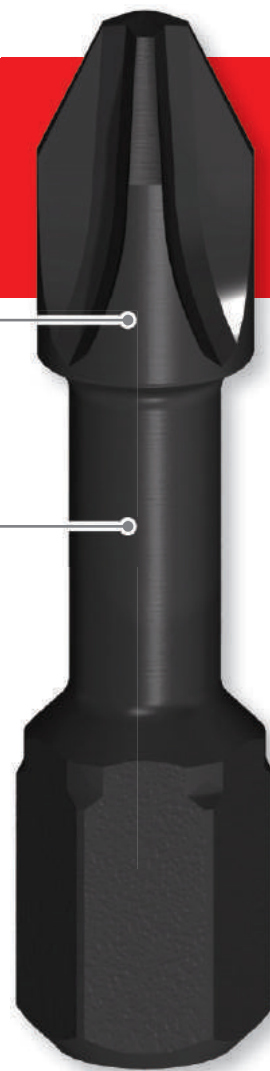

Aplicações
applications

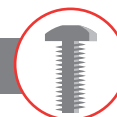
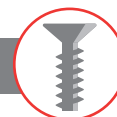

Concebidas e testadas para utilização com aparafusadoras de impacto.

Designed and tested for use with impact wrenches.



Alta resistência aos impulsos, mesmo a velocidades elevadas. Suporta tensões até 300% mais do que uma ponta tradicional.

High pulse strength, even at high speeds. Withstands stress up to 300% higher than traditional bits.



Perfil reduzido para otimizar a resistência às tensões de torção, absorve o dobro da deformação em relação às Bit's normais.

Reduced profile to optimise resistance to twisting, withstands twice the deformation of normal bits.



61210 PH PULSAR®

BIT'S 1/4" C PHILLIPS® - PARA APARAFUSADORAS DE IMPACTO
1/4" C PHILLIPS® BITS - FOR IMPACT WRENCHES

58/60 HRC



MINIBOX
10 un.

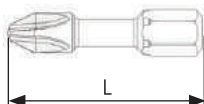

EASYPACK | caixa PVC com Euro-hole #PVC bags with Euro-hole

	L mm	CÓD.	€ box
PH1	30	61210005010	
PH2	30	61210010010	
PH3	30	61210015010	

61211 PH PULSAR®

BIT'S 1/4" E PHILLIPS® - PARA APARAFUSADORAS DE IMPACTO
1/4" E PHILLIPS® POWER BITS - FOR IMPACT WRENCHES

58/60 HRC



MINIBOX
5 un.

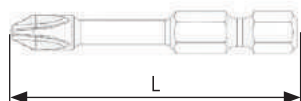

EASYPACK | caixa PVC com Euro-hole #PVC bags with Euro-hole

	L mm	CÓD.	€ box
PH1	50	61211005005	
PH2	50	61211010005	
PH3	50	61211015005	

61220 PZ PULSAR®

BIT'S 1/4" C POZIDRIV® - PARA APARAFUSADORAS DE IMPACTO
1/4" C POZIDRIV® BITS - FOR IMPACT WRENCHES

58/60 HRC



MINIBOX
10 un.

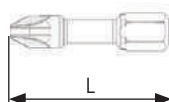

EASYPACK | caixa PVC com Euro-hole #PVC bags with Euro-hole

	L mm	CÓD.	€ box
PZ1	30	61220005010	
PZ2	30	61220010010	
PZ3	30	61220015010	



LINHA PREMIUM

PREMIUM LINES

61221

PZ PULSAR®

BIT'S 1/4"E POZIDRIV® - PARA APARAFUSADORAS DE IMPACTO
1/4"E POZIDRIV® BITS - FOR IMPACT WRENCHES

58/60 HRC



MINIBOX
5 un.

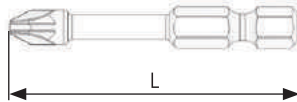

EASYPACK | caixa PVC com Euro-hole #PVC bags with Euro-hole



L mm

CÓD.

€
box

PZ1 50 61221005005

PZ2 50 61221010005

PZ3 50 61221015005

61230

TX PULSAR®

BIT'S 1/4"C PARA PARAFUSOS TORX® - PARA APARAFUSADORAS DE IMPACTO
1/4"C BITS FOR TORX® SCREWS - FOR IMPACT WRENCHES

58/60 HRC



MINIBOX
10 un.

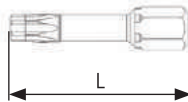

EASYPACK | caixa PVC com Euro-hole #PVC bags with Euro-hole



L mm

CÓD.

€
box

TX10 30 61230003010

TX15 30 61230004010

TX20 30 61230005010

TX25 30 61230010010

TX27 30 61230013010

TX30 30 61230015010

TX40 30 61230020010

61231

TX PULSAR®

BIT'S 1/4"E PARA PARAFUSOS TORX® - PARA APARAFUSADORAS DE IMPACTO
1/4"E POWER BITS FOR TORX® SCREWS - FOR IMPACT WRENCHES

58/60 HRC



MINIBOX
5 un.

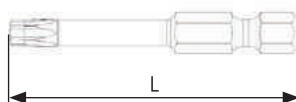

EASYPACK | caixa PVC com Euro-hole #PVC bags with Euro-hole



L mm

CÓD.

€
box

TX10 50 61231003005

TX15 50 61231004005

TX20 50 61231005005

TX25 50 61231010005

TX27 50 61231013005

TX30 50 61231015005

TX40 50 61231020005



61200 HEX PULSAR®

BIT'S 1/4"C SEXTAVADAS - PARA APARAFUSADORAS DE IMPACTO
1/4"C HEX BITS - FOR IMPACT WRENCHES

58/60 HRC



MINIBOX
10 un.

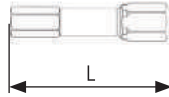

EASYPACK | caixa PVC com Euro-hole PVC bags with Euro-hole

Ø	L mm	CÓD.	€ box
4	30	61200005010	
5	30	61200010010	
6	30	61200015010	

61201 HEX PULSAR®

BIT'S 1/4"E SEXTAVADAS - PARA APARAFUSADORAS DE IMPACTO
1/4"E HEX BITS - FOR IMPACT WRENCHES

58/60 HRC



MINIBOX
5 un.

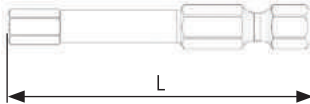

EASYPACK | caixa PVC com Euro-hole PVC bags with Euro-hole

Ø	L mm	CÓD.	€ box
4	50	61201005005	
5	50	61201010005	
6	50	61201015005	



62035

SUPOORTE DE BIT'S PULSAR®

SUPOORTE DE BIT'S MAGNÉTICO ANTICHOQUE PARA APARAFUSADORAS DE IMPACTO
MAGNETIC BIT-HOLDER ANTI-SHOCK FOR IMPACT WRENCHES

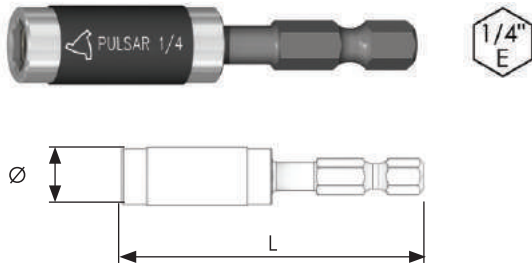

EASYPACK | caixa PVC com Euro-hole | PVC bags with Euro-hole

L mm	Ø mm	UN.	CÓD.	€ box
60	11	5	62035005002	

DESEMPENHO PONTA + SUPOORTE DE BIT'S
Bit + bit-holder performances

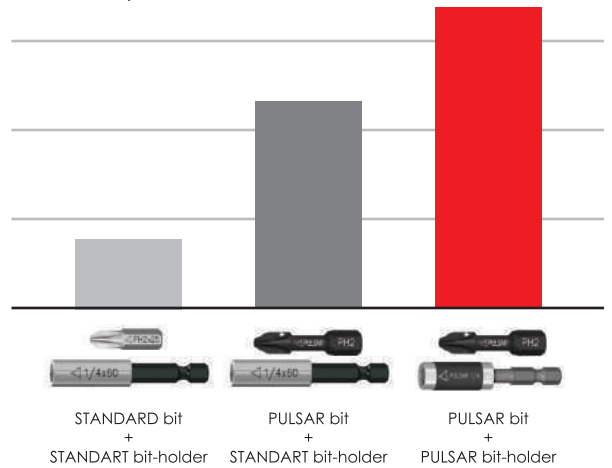

FOCUS ON

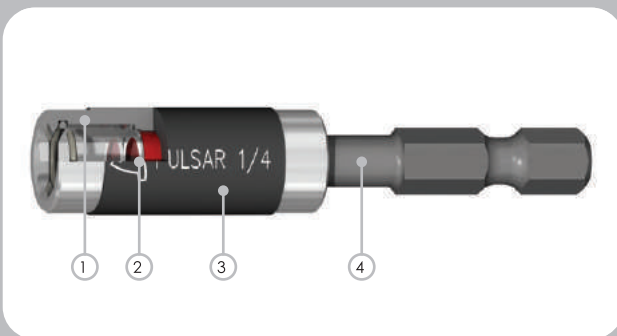

- ① Corpo reforçado
Reinforced body
- ② Sistema antichoque para proteger o ímã
Antishock system to protect the magnet
- ③ Bainha de proteção do corpo
Protection sheath for the body
- ④ Sextavado rebaixado que aumenta o ângulo de binário, protegendo a ponta da deformação
Low-rise hexagon that increases the torque angle, protecting the insert from deformation

Especialmente concebido para trabalhar com Bit's da gama LTI PULSAR: as geometrias exclusivas de construção otimizam o funcionamento das Bit's, garantindo uma durabilidade e desempenho extraordinários.

Designed specifically to work with the range of LTI PULSAR bits: the exclusive construction geometries optimise the work of the bits, guaranteeing durability and outstanding performances.

**LAB
TEST**





66002

MYBIT 7
JOGO PULSAR®

CONJUNTO 7 UN. - BIT'S + SUPORTE DE BIT'S
7 UN. SET - BITS + BIT-HOLDER

CÓD. **66002200**



7 un.

61210



PH2
1 un.

PH3
1 un.

61220



PZ2
1 un.

PZ3
1 un.

61230



TX30
1 un.

TX40
1 un.



100 X 120 mm



INCLUÍDO / INCLUDED

CÓD. 62035005002



66002

DISPLAY MYBIT 7
PULSAR®

EXPOSITOR DE BANCADA EM ACRÍLICO PARA 12 CONJUNTOS DE BIT'S
12 UN. BIT-SETS PLEXIGLASS COUNTER DISPLAY

CÓD. **66002204**

12 un.



150 X 40 X 195 mm



12 un.
CÓD. 66002200



LINHA PREMIUM

PREMIUM LINES

66007

MYBIT 7 POWER JOGO PULSAR®

CONJUNTO 7 UN. - BIT'S
7 UN. SET - BITS

NEW!

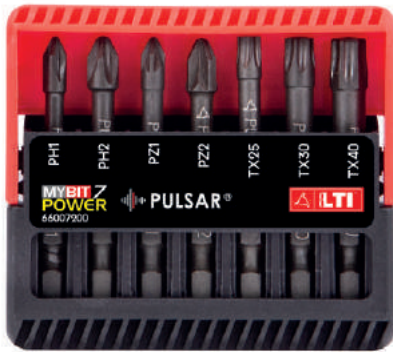

7
un.

CÓD. 66007200

61211 L=50mm		61221 L=50mm		61231 L=50mm		
PH1 1 un.	PH2 1 un.	PZ1 1 un.	PZ2 1 un.	TX25 1 un.	TX30 1 un.	TX40 1 un.



100 X 120 mm



66005

MYBIT 10 JOGO PULSAR®

CONJUNTO 10 UN. - BIT'S + SUPORTE DE BIT'S
10 UN. SET - BITS + BIT-HOLDER



10
un.

CÓD. 66005200

61210		61220		61230		61200	
PH2 2 un.	PH3 1 un.	PZ2 1 un.	PZ3 1 un.	TX30 1 un.	TX40 1 un.	E5 1 un.	E6 1 un.



100 X 120 mm



INCLUÍDO / INCLUDED

CÓD. 62035005002





66005

**DISPLAY MYBIT10
PULSAR®**

EXPOSITOR DE BANCADA EM ACRÍLICO PARA 12 CONJUNTOS DE BIT'S
12 UN. BIT-SETS PLEXIGLASS COUNTER DISPLAY



150 X 40 X 195 mm

12
un.

CÓD. **66005204**



12 un.
CÓD. 66005200



BIT'S 1/4" RÍGIDAS, RESISTENTES A BINÁRIOS ELEVADOS

1/4" heavy duty bits, high torques resistant

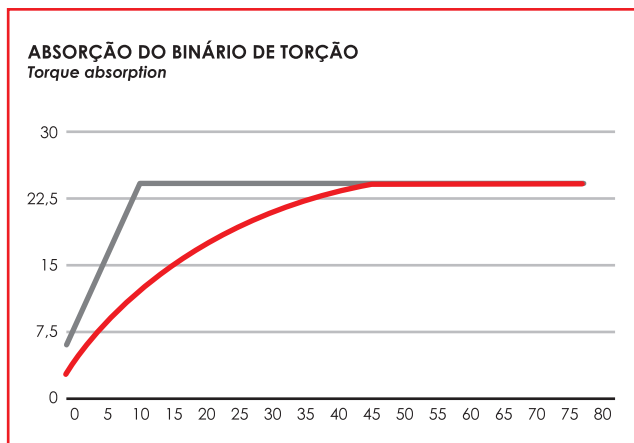
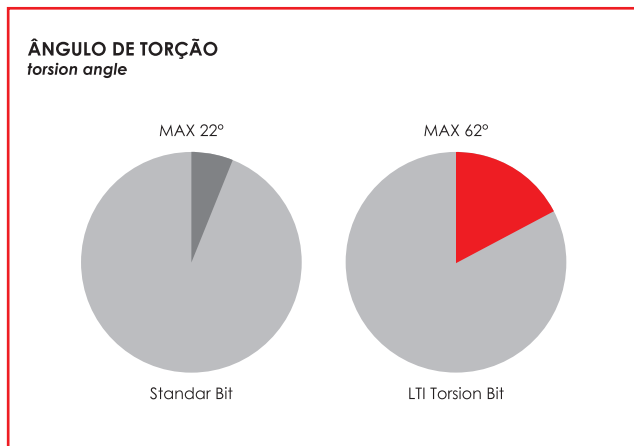

Aplicações
applications

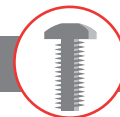

O design exclusivo permite distribuir o esforço de torção ao longo de toda a ferramenta.

The exclusive design allows distributing the torsional stress along the entire length of the tool.



Grau de resistência adequado para absorver picos de binário ao aparafusar materiais duros.

Tough grade, suitable for absorbing torque peaks when screwing into hard materials.



Minimizando os picos reduz o desgaste, maximizando a vida útil da ferramenta.

Minimisation of peaks reduces wear and maximises tool life.



61058 PH TORSION®

BIT'S 1/4" C PHILLIPS® - RÍGIDAS, RESISTENTES A BINÁRIOS ELEVADOS
1/4" C PHILLIPS® BITS - HEAVY DUTY, RESISTANT TO HIGH TORQUES

58/60 HRC



MINIBOX
10 un.

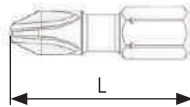

EASYPACK | caixa PVC com Euro-hole PVC bags with Euro-hole

+	L mm	CÓD.	€ box
PH1	25	61058005010	
PH2	25	61058010010	
PH3	25	61058015010	

61059 PH TORSION®

BIT'S 1/4" E PHILLIPS® - RÍGIDAS, RESISTENTES A BINÁRIOS ELEVADOS
1/4" E PHILLIPS® POWER BITS - HEAVY DUTY, RESISTANT TO HIGH TORQUES

58/60 HRC



MINIBOX
5 un.

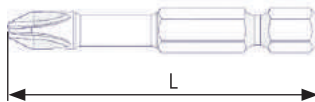

EASYPACK | caixa PVC com Euro-hole PVC bags with Euro-hole

+	L mm	CÓD.	€ box
PH1	50	61059005005	
PH2	50	61059010005	
PH3	50	61059015005	

61083 PZ TORSION®

BIT'S 1/4" C POZIDRIV® - RÍGIDAS, RESISTENTES A BINÁRIOS ELEVADOS
1/4" C POZIDRIV® BITS - HEAVY DUTY, RESISTANT TO HIGH TORQUES

58/60 HRC



MINIBOX
10 un.

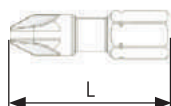

EASYPACK | caixa PVC com Euro-hole PVC bags with Euro-hole

+	L mm	CÓD.	€ box
PZ1	25	61083005010	
PZ2	25	61083010010	
PZ3	25	61083015010	



LINHA PREMIUM

PREMIUM LINES

61084 PZ TORSION®

58/60 HRC

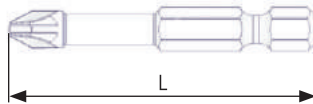

BIT'S 1/4" E POZIDRIV® - RÍGIDAS, RESISTENTES A BINÁRIOS ELEVADOS
1/4" E POZIDRIV® POWER BITS - HEAVY DUTY, RESISTANT TO HIGH TORQUES

EASYPACK | caixa PVC com Euro-hole PVC bags with Euro-hole

	L mm	CÓD.	€ box
PZ1	50	61084005005	
PZ2	50	61084010005	
PZ3	50	61084015005	

61103 TX TORSION®

58/60 HRC



BIT'S 1/4" C PARA PARAFUSOS TORX® - RÍGIDAS, RESISTENTES A BINÁRIOS ELEVADOS
1/4" C BITS FOR TORX® SCREWS - HEAVY DUTY, RESISTANT TO HIGH TORQUES

EASYPACK | caixa PVC com Euro-hole PVC bags with Euro-hole

	L mm	CÓD.	€ box
TX10	25	61103005010	
TX15	25	61103010010	
TX20	25	61103015010	
TX25	25	61103020010	
TX27	25	61103025010	
TX30	25	61103030010	
TX40	25	61103035010	

61104 TX TORSION®

58/60 HRC

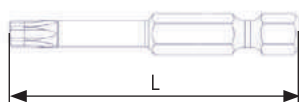

BIT'S 1/4" E PARA PARAFUSOS TORX® - RÍGIDAS, RESISTENTES A BINÁRIOS ELEVADOS
1/4" E POWER BITS FOR TORX® SCREWS - HEAVY DUTY, RESISTANT TO HIGH TORQUES

EASYPACK | caixa PVC com Euro-hole PVC bags with Euro-hole

	L mm	CÓD.	€ box
TX10	50	61104005005	
TX15	50	61104010005	
TX20	50	61104015005	
TX25	50	61104020005	
TX27	50	61104025005	
TX30	50	61104030005	
TX40	50	61104035005	



62018 ARTICULADOS

SUPORE DE BIT'S 1/4"E ARTICULADO COM BLOQUEIO PARA BIT'S 1/4"C
ARTICULATED 1/4"E BIT HOLDER WITH LOCK FOR 1/4"C BITS

EASYPACK | caixa PVC com Euro-hole PVC bags with Euro-hole



L mm	Ø mm	UN.	CÓD.	€ box
94	14	2	62018005002	



FOCUS ON

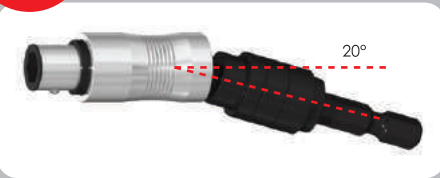

Ideal para trabalhar em espaços pequenos ou desconfortáveis onde não é possível aparafusar na direção do eixo do parafuso. Movendo a porca de anel, pode trabalhar na posição direita.
Ideal for working in tight or difficult spaces where a second screw cannot be inserted. Move the ring nut to work in a straight position.



66002 MYBIT 7 JOGO TORSION®

CONJUNTO 7 UN. - BIT'S + SUPORTE DE BIT'S
7 UN. SET - BITS + BIT-HOLDER

CÓD. 66002300



7 un.

61058 +			61083 +		
PH1 1 un.	PH2 1 un.	PH3 1 un.	PZ1 1 un.	PZ2 1 un.	PZ3 1 un.



100 X 120 mm



INCLUÍDO / INCLUDED

CÓD. 62013005002





LINHA PREMIUM

PREMIUM LINES

66002

DISPLAY MYBIT 7 TORSION®

EXPOSITOR DE BANCADA EM ACRÍLICO PARA 12 CONJUNTOS DE BIT'S
12 UN. BIT-SETS PLEXIGLASS COUNTER DISPLAY



150 X 40 X 195 mm

12
un.

CÓD. 66002304

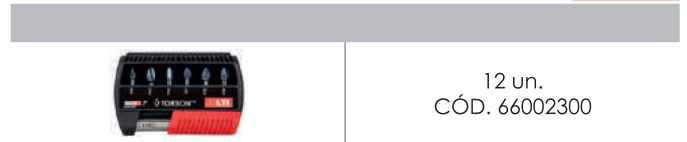

12 un.
CÓD. 66002300

66007

MYBIT 7 POWER JOGO TORSION®

CONJUNTO 7 UN. - BIT'S
7 UN. SET - BITS

NEW!

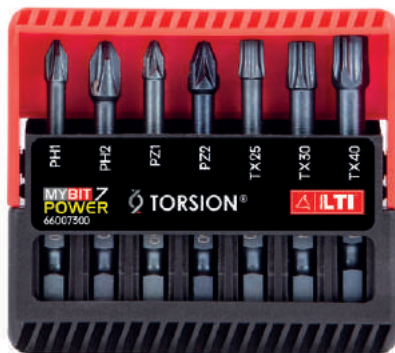

7
un.

CÓD. 66007300

61059	⊕ L=50mm	61084	⊕ L=50mm	61104	⊕ L=50mm
PH1	PH2	PZ1	PZ2	TX25	TX30
1 un.	1 un.	1 un.	1 un.	1 un.	1 un.



100 X 120 mm





by



66005

MYBIT 10 JOGO TORSION®

CONJUNTO 10 UN. - BIT'S + SUPORTE DE BIT'S
10 UN. SET - BITS + BIT-HOLDER

CÓD. **66005300**



10
un.

61058			61083			61103		
PH1	PH2	PH3	PZ1	PZ2	PZ3	TX20	TX25	TX30
1 un.	1 un.	1 un.	1 un.	1 un.	1 un.	1 un.	1 un.	1 un.



100 X 120 mm



INCLUÍDO / INCLUDED

CÓD. 62013005002



66005

DISPLAY MYBIT 10 TORSION®

EXPOSITOR DE BANCADA EM ACRÍLICO PARA 12 CONJUNTOS DE BIT'S
12 UN. BIT-SETS PLEXIGLASS COUNTER DISPLAY

CÓD. **66005304**



150 X 40 X 195 mm

12
un.



12 un.
CÓD. 66005300



LINHA PREMIUM

PREMIUM LINES

66006

MYBIT 15

JOGO TORSION®

CONJUNTO 15 UN. - BIT'S + SUPORTE DE BIT'S
15 UN. SET - BITS + BIT-HOLDER



15 un.

CÓD. **66006305**



100 X 167 mm



INCLUÍDO / INCLUDED

CÓD. 62013005002



61058			61083		
PH1 1 un.	PH2 1 un.	PH3 1 un.	PZ1 1 un.	PZ2 1 un.	PZ3 1 un.
61103					
TX10 1 un.	TX15 1 un.	TX20 1 un.	TX25 1 un.	TX30 1 un.	TX40 1 un.
61059			61084		
PH2 1 un.			PZ2 1 un.		

66006

DISPLAY MYBIT 15

TORSION®

EXPOSITOR DE BANCADA EM ACRÍLICO PARA 12 CONJUNTOS DE BIT'S
12 UN. BIT-SETS PLEXIGLASS COUNTER DISPLAY



12 un.

CÓD. **66006309**



12 un.
CÓD. 66006305

185 X 40 X 195 mm



by



66006

MYBIT 14

JOGO TORSÃO® COM CHAVE ROQUETE

CONJUNTO 14 UN. TORSION® / CHAVE ROQUETE
14 UN. SET - BITS + BIT HOLDER AND RATCHET

NEW!

CÓD. **66006505**

14 un.



100 X 170 mm



61058			61069		
PH1	PH2	PH3	PZ1	PZ2	PZ3
1 un.	1 un.	1 un.	1 un.	1 un.	1 un.
61103					
TX10	TX15	TX20	TX25	TX30	TX40
1 un.	1 un.	1 un.	1 un.	1 un.	1 un.

INCLUÍDO / INCLUDED

CÓD. 62013005002



CÓD. 64221030





BIT'S 1/4" COM REVESTIMENTO DE DIAMANTE

1/4" bits with diamond coating

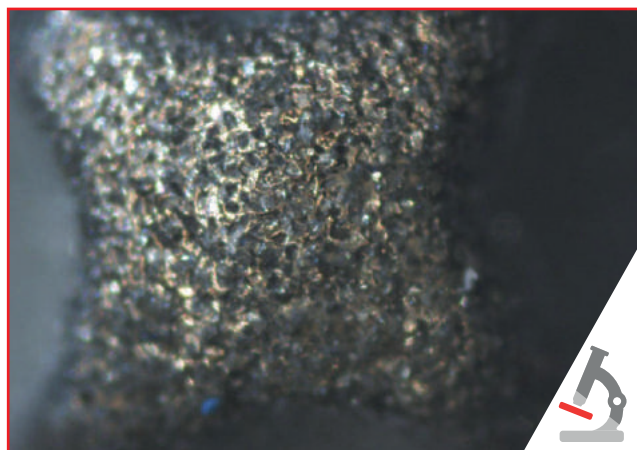

Revestimento de diamante eletrodepositado
Electro-deposited diamond coating



REDUÇÃO COM EFEITO DE SAÍDA

Reduced come-out effect

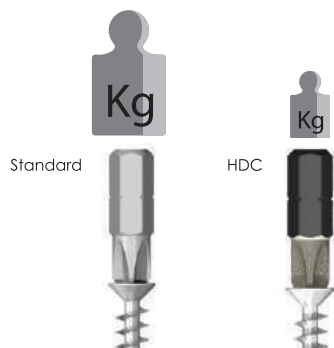

Aplicações
applications

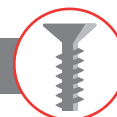

As minúsculas partículas de diamante aderem à fenda do parafuso, o efeito de saída é reduzido, o operador pode aparafusar com menos força e mais segurança.

The tiny diamond particles become entrapped in the slot of the screws, reducing the come-out effect, so that the operator can screw with less force and greater safety.



A ponta não desliza do parafuso, reduzindo o risco de danificar tanto a extremidade da ferramenta, como a cabeça do parafuso.

The bit does not slip from the screw, which reduces the risk of damaging the tool tip and screw head.



A excelente aderência proporcionada por este revestimento também permite utilizar as Bit's HDC para desapertar parafusos danificados ou enferrujados.

The excellent grip exerted by this coating allows using HDC bits also to unscrew damaged or rusty screws.



61310 PH HDC

BIT'S 1/4" C PHILLIPS® - COM REVESTIMENTO DE DIAMANTE
1/4" C PHILLIPS® BITS - WITH DIAMOND COATING

58/60 HRC

EASYPACK | caixa PVC com Euro-hole PVC bags with Euro-hole



MINIBOX
10 un.

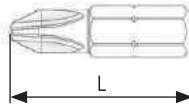

+	L mm	CÓD.	€ box
PH1	25	61310005010	
PH2	25	61310010010	
PH3	25	61310015010	

61311 PH HDC

BIT'S 1/4" E PHILLIPS® - COM REVESTIMENTO DE DIAMANTE
1/4" E PHILLIPS® POWER BITS - WITH DIAMOND COATING

58/60 HRC

EASYPACK | caixa PVC com Euro-hole PVC bags with Euro-hole



MINIBOX
5 un.

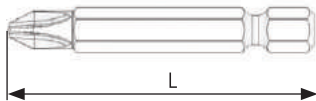

+	L mm	CÓD.	€ box
PH1	50	61311005005	
PH2	50	61311010005	
PH3	50	61311015005	

61320 PZ HDC

BIT'S 1/4" C POZIDRIV® - COM REVESTIMENTO DE DIAMANTE
1/4" C POZIDRIV® BITS - WITH DIAMOND COATING

58/60 HRC

EASYPACK | caixa PVC com Euro-hole PVC bags with Euro-hole



MINIBOX
10 un.



+	L mm	CÓD.	€ box
PZ1	25	61320005010	
PZ2	25	61320010010	
PZ3	25	61320015010	



LINHA PREMIUM

PREMIUM LINES

61321

PZ HDC

BIT'S 1/4"E POZIDRIV® - COM REVESTIMENTO DE DIAMANTE
1/4"E POZIDRIV® POWER BITS - WITH DIAMOND COATING

58/60 HRC

EASYPACK | caixa PVC com Euro-hole PVC bags with Euro-hole



MINIBOX
5 un.



L mm

CÓD.

€
box

PZ1 50 61321005005

PZ2 50 61321010005

PZ3 50 61321015005

61330

TX HDC

BIT'S 1/4"C PARA PARAFUSOS TORX® - COM REVESTIMENTO DE DIAMANTE
1/4"C BITS FOR TORX® SCREWS - WITH DIAMOND COATING

58/60 HRC

EASYPACK | caixa PVC com Euro-hole PVC bags with Euro-hole



MINIBOX
10 un.

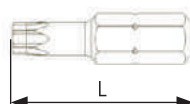

L mm

CÓD.

€
box

TX10 25 61330005010

TX15 25 61330010010

TX20 25 61330015010

TX25 25 61330020010

TX30 25 61330030010

TX40 25 61330035010



62016 MANDRIL DE BLOQUEIO

SUPORE DE BIT'S 1/4"E MAGNÉTICO COM MANDRIL DE BLOQUEIO PARA BIT'S 1/4"C
MAGNETIC 1/4"E BIT-HOLDER WITH LOCK CHUCK FOR 1/4"C BITS

EASYPACK | caixa PVC com Euro-hole PVC bags with Euro-hole

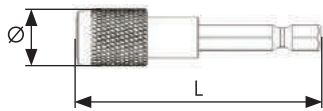

L mm	UN.	CÓD.	€ box
60	2	62016005002	



FOCUS ON

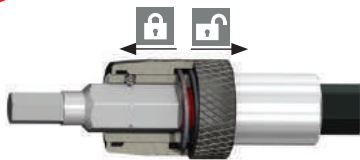

As esferas de vedação bloqueiam a ponta: este artigo é recomendado para utilização com Bit's sextavadas que tendem a bloquear na fenda do parafuso.

The sealing balls block the bit: this article is recommended for use with hexagon bits that tend to become blocked in the slot of the screw.



66002 MYBIT 7 JOGO HDC

CONJUNTO 7 UN. - BIT'S + SUPORE DE BIT'S
7 UN. SET - BITS + BIT-HOLDER

CÓD. **66002380**



7 un.

61310		61320		61305	
PH1	PH2	PZ1	PZ2	0,6x4,5	1,2x6,5
1 un.	1 un.	1 un.	1 un.	1 un.	1 un.



100 X 120 mm



INCLUÍDO / INCLUDED

CÓD. 62015010002





LINHA PREMIUM

PREMIUM LINES

66002

DISPLAY MYBIT 7 HDC

EXPOSITOR DE BANCADA EM ACRÍLICO PARA 12 CONJUNTOS DE BIT'S
12 UN. BIT-SETS PLEXIGLASS COUNTER DISPLAY



12
un.

CÓD. **66002384**



12 un.
CÓD. 66002380

150 X 40 X 195 mm

66007

MYBIT 7 POWER JOGO HDC

CONJUNTO 7 UN. - BIT'S
7 UN. SET - BITS

NEW!

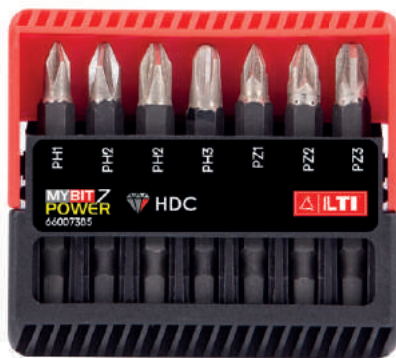

7
un.

CÓD. **66007385**

61311 L=50mm



PH1	PH2	PH3
1 un.	2 un.	1 un.

61321 L=50mm



PZ1	PZ2	PZ3
1 un.	1 un.	1 un.



100 X 120 mm





66005 **MYBIT 10**
JOGO HDC

CONJUNTO 10 UN. - BIT'S + SUPORTE DE BIT'S
10 UN. SET - BITS + BIT-HOLDER

CÓD. **66005385**



10
un.

61310			61320			61330		
PH1	PH2	PH3	PZ1	PZ2	PZ3	TX25	TX30	TX40
1 un.	1 un.	1 un.	1 un.	1 un.	1 un.	1 un.	1 un.	1 un.



100 X 120 mm



INCLUÍDO / INCLUDED

CÓD. 62015010002

66005 **DISPLAY MYBIT 10**
HDC

EXPOSITOR DE BANCADA EM ACRÍLICO PARA 12 CONJUN-
TOS DE BIT'S
12 UN. BIT-SETS PLEXIGLASS COUNTER DISPLAY

CÓD. **66005389**

12
un.



150 X 40 X 195 mm

12 un.
CÓD. 66005385



LINHA PREMIUM

PREMIUM LINES

66006

MYBIT 15 JOGO HDC

CONJUNTO 15 UN. - BIT'S + SUPORTE DE BIT'S
15 UN. SET - BITS + BIT-HOLDER



15
un.



100 X 167 mm



INCLUÍDO / INCLUDED

CÓD. 62015010002



CÓD. **66006320**

61310			61320		
PH1 1 un.	PH2 1 un.	PH3 1 un.	PZ1 1 un.	PZ2 1 un.	PZ3 1 un.
61330			61305		
TX20 1 un.	TX25 1 un.	TX30 1 un.	0,6x4,0 1 un.	0,8x5,5 1 un.	1,2x6,5 1 un.
61311			61321		
PH2 1 un.			PZ2 1 un.		

66006

DISPLAY MYBIT 15 HDC

EXPOSITOR DE BANCADA EM ACRÍLICO PARA 12 CONJUNTOS DE
BIT'S
12 UN. BIT-SETS PLEXIGLASS COUNTER DISPLAY



12
un.

185 X 40 X 195 mm

CÓD. **66006324**



12 un.
CÓD. 66006320



66006

MYBIT 14

JOGO HDC COM CHAVE ROQUETE

CONJUNTO 14 UN. HDC / CHAVE ROQUETE
14 UN. SET - BITS + BIT HOLDER AND RATCHET

NEW!

14
un.

CÓD. **66006515**



100 X 170 mm



61310					
PH1	PH2	PH3	PZ1	PZ2	PZ3
1 un.	1 un.	1 un.	1 un.	1 un.	1 un.
61330					
TX20	TX25	TX30	4x0,6	5,5x0,8	6,5x1,2
1 un.	1 un.	1 un.	1 un.	1 un.	1 un.
61320					
61305					

INCLUÍDO / INCLUDED

CÓD. 62015010002

CÓD. 64221030





BIT'S 1/4" EM AÇO INOXIDÁVEL

1/4" stainless steel bits

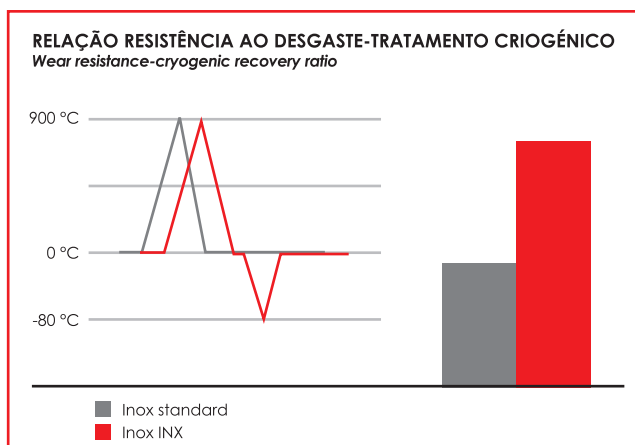
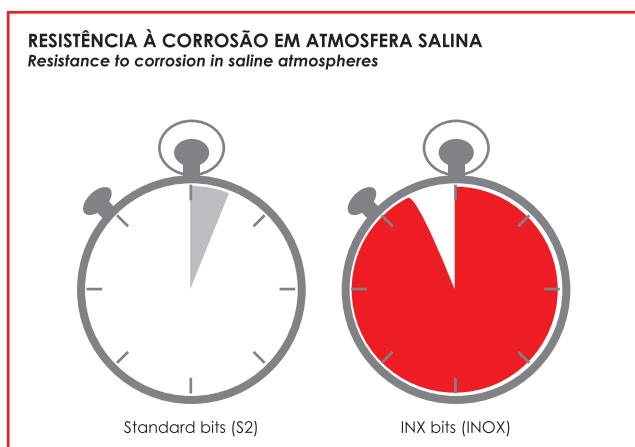

Aplicações
applications

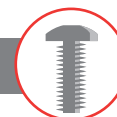
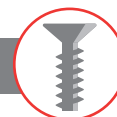

Inteiramente realizadas em aço inoxidável.

Made entirely of stainless steel.



Para trabalhos em condições extremas: resistem à corrosão mesmo em contacto com a água do mar.

For extreme conditions applications: corrosion resistant, even in contact with seawater.



Adequadas para uso com parafusos de aço inoxidável, uma vez que não causam/desencadeiam a oxidação.

Suitable for use with stainless steel screws as they do not cause or generate oxidation.



61410 PH INX

BIT'S 1/4" C PHILLIPS® - EM AÇO INOXIDÁVEL
1/4" C PHILLIPS® BITS - IN STAINLESS STEEL

54/56 HRC



MINIBOX
10 un.

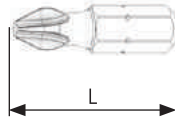

EASYPACK | caixa PVC com Euro-hole PVC bags with Euro-hole

+	L mm	CÓD.	€ box
PH1	25	61410005010	
PH2	25	61410010010	
PH3	25	61410015010	

61420 PZ INX

BIT'S 1/4" C POZIDRIV® - EM AÇO INOXIDÁVEL
1/4" C POZIDRIV® BITS - IN STAINLESS STEEL

54/56 HRC



MINIBOX
10 un.

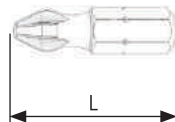

EASYPACK | caixa PVC com Euro-hole PVC bags with Euro-hole

+	L mm	CÓD.	€ box
PZ1	25	61420005010	
PZ2	25	61420010010	
PZ3	25	61420015010	

61430 TX INX

BIT'S 1/4" C PARA PARAFUSOS TORX® - EM AÇO INOXIDÁVEL
1/4" C BITS FOR TORX® SCREWS - IN STAINLESS STEEL

54/56 HRC



MINIBOX
10 un.

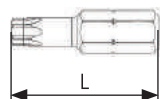

EASYPACK | caixa PVC com Euro-hole PVC bags with Euro-hole

+	L mm	CÓD.	€ box
TX10	25	61430005010	
TX15	25	61430010010	
TX20	25	61430015010	
TX25	25	61430020010	
TX30	25	61430030010	
TX40	25	61430035010	



LINHA PREMIUM

PREMIUM LINES

61400 HEX INX

BIT'S 1/4" C SEXTAVADAS - EM AÇO INOXIDÁVEL
1/4" C HEX BITS - IN STAINLESS STEEL

54/56 HRC

EASYPACK | caixa PVC com Euro-hole PVC bags with Euro-hole

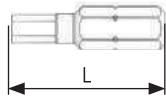

MINIBOX
10 un.

Ø	L mm	CÓD.	€ box
2	25	6140005010	
2,5	25	61400010010	
3	25	61400015010	
4	25	61400020010	
5	25	61400025010	
6	25	61400030010	

62015 SUPORTE DE BIT'S INX

SUPORTE DE BIT'S 1/4" E EM AÇO INOXIDÁVEL INTEGRAL MAGNÉTICO COM ANEL PARA BIT'S 1/4" C
1/4" E STAINLESS STEEL BIT HOLDER WITH C-RING AND MAGNET FOR 1/4" C BITS

EASYPACK | caixa PVC com Euro-hole PVC bags with Euro-hole

NEW!

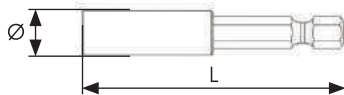

L mm	Ø mm	UN.	CÓD.	€ box
60	11	2	62015105002	



62016

**SUPOORTE DE BIT'S INX
MANDRIL DE BLOQUEIO**

SUPOORTE DE BIT'S 1/4"E EM AÇO INOXIDÁVEL MAGNÉTICO COM MANDRIL DE BLOQUEIO
1/4"E STAINLESS STEEL BIT HOLDER WITH LOCK CHUCK AND MAGNET

NEW!

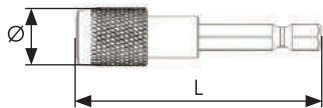

L mm	Ø mm	UN.	CÓD.	€ box
60	14	2	62016105002	

EASYPACK | caixa PVC com Euro-hole PVC bags with Euro-hole

FOCUS ON

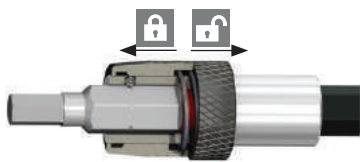

As esferas de vedação bloqueiam a ponta: este artigo é recomendado para utilização com Bit's sextavadas que tendem a bloquear na fenda do parafuso.

The sealing balls block the bit: this article is recommended for use with hexagon bits that tend to become blocked in the slot of the screw.



62015

SUPOORTE DE BIT'S INX

SUPOORTE DE BIT'S 1/4"E EM AÇO INOXIDÁVEL INTEGRAL MAGNÉTICO COM ANEL PARA BIT'S 1/4"C
1/4"E STAINLESS STEEL BIT HOLDER WITH C-RING AND MAGNET FOR 1/42C BITS

NEW!

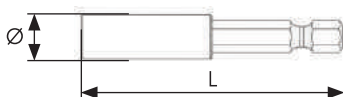

L mm	Ø mm	UN.	CÓD.	€ box
60	11	2	62015105002	

EASYPACK | caixa PVC com Euro-hole PVC bags with Euro-hole



LINHA PREMIUM

PREMIUM LINES

62016

SUPOORTE DE BIT'S INX MANDRIL DE BLOQUEIO

SUPOORTE DE BIT'S 1/4"E EM AÇO INOXIDÁVEL MAGNÉTICO COM MANDRIL DE BLOQUEIO
1/4"E STAINLESS STEEL BIT HOLDER WITH LOCK CHUCK AND MAGNET

NEW!



EASYPACK | caixa PVC com Euro-hole PVC bags with Euro-hole

L mm	Ø mm	UN.	CÓD.	€ box
60	14	2	62016105002	

FOCUS ON

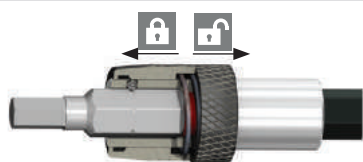

As esferas de vedação bloqueiam a ponta: este artigo é recomendado para utilização com Bit's sextavadas que tendem a bloquear na fenda do parafuso.

The sealing balls block the bit: this article is recommended for use with hexagon bits that tend to become blocked in the slot of the screw.



66002

MYBIT 7 JOGO INX

CONJUNTO 7 UN. - BIT'S + SUPORTE DE BIT'S
7 UN. SET - BITS + BIT-HOLDER



7 un.

CÓD. **66002400**



PH1
1 un.



PH2
1 un.



PZ1
1 un.



PZ2
1 un.



0,6x4,5
1 un.



1,2x6,5
1 un.



100 X 120 mm



INCLUÍDO / INCLUDED

CÓD. 62015105002





66002 DISPLAY MYBIT 7 INX

EXPOSITOR DE BANCADA EM ACRÍLICO PARA 12 CONJUNTOS DE BIT'S
12 UN. BIT-SETS PLEXIGLASS COUNTER DISPLAY



12 un.

CÓD. 66002404

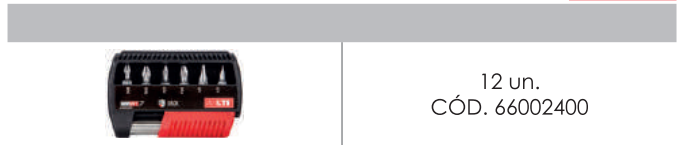

12 un.
CÓD. 66002400

150 X 40 X 195 mm

66005 MYBIT 10 JOGO INX

CONJUNTO 10 UN. - BIT'S + SUPORTE DE BIT'S
10 UN. SET - BITS + BIT-HOLDER



10 un.

CÓD. 66005400

61410			61420			61405		
PH1	PH2	PH3	PZ1	PZ2	PZ3	0,6x4,5	0,8x5,5	1,2x6,5
1 un.	1 un.	1 un.	1 un.	1 un.	1 un.	1 un.	1 un.	1 un.



100 X 120 mm



INCLUÍDO / INCLUDED

CÓD. 62015105002



LINHA PREMIUM

PREMIUM LINES

66005

DISPLAY MYBIT10 INX

EXPOSITOR DE BANCADA EM ACRÍLICO PARA 12 CONJUNTOS DE BIT'S
12 UN. BIT-SETS PLEXIGLASS COUNTER DISPLAY



150 X 40 X 195 mm

12 un.

CÓD. **66005404**

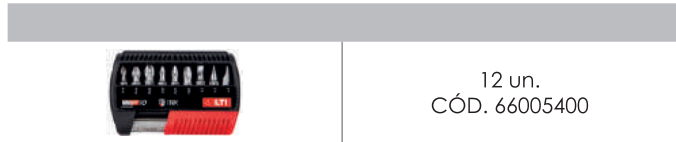

12 un.
CÓD. 66005400

66006

MYBIT14 JOGO INX CON CHAVE ROQUETE

CONJUNTO 14 UN. INX / CHAVE ROQUETE
14 UN. SET - BITS + BIT HOLDER AND RATCHET

NEW!

CÓD. **66006525**

14 un.



100 X 170 mm



CÓD. 66006525					
61410			61420		
PH1	PH2	PH3	PZ1	PZ2	PZ3
1 un.	1 un.	1 un.	1 un.	1 un.	1 un.
61430			61405		
TX25	TX30	TX40	0,6x4,5	0,8x5,5	1,2x6,5
1 un.	1 un.	1 un.	1 un.	1 un.	1 un.

INCLUIDO / INCLUDED

CÓD. 62015105002



CÓD. 64221030





*Doca seca de um estaleiro naval.
Dry dock of a shipyard.*

SUPOORTE DE BIT'S

SUPOORTE DE BIT'S PARA BIT'S 1/4"C E BIT'S 1/4"E

Bit holder for 1/4"C bits and 1/4"E power-bits

Corpo em aço inoxidável (HRA 64/66) resistente às tensões transmitidas pela ponta. Ímã permanente em neodímio-ferro-boro; força de retenção 100% superior à exigida pelas normas internacionais.

Body in STAINLESS steel (HRA 64/66), resistant to stress transmitted by the insert bit. Permanent magnet in Neodymium-Iron-Boron; retention strength greater than 100% as required by international standards.

Engate em S2, o mesmo material utilizado para o fabrico das Bit's Essential. Excelente resistência ao desgaste.

Attachment in S2, the same material used to manufacture the Essential bits. Excellent wear resistance.

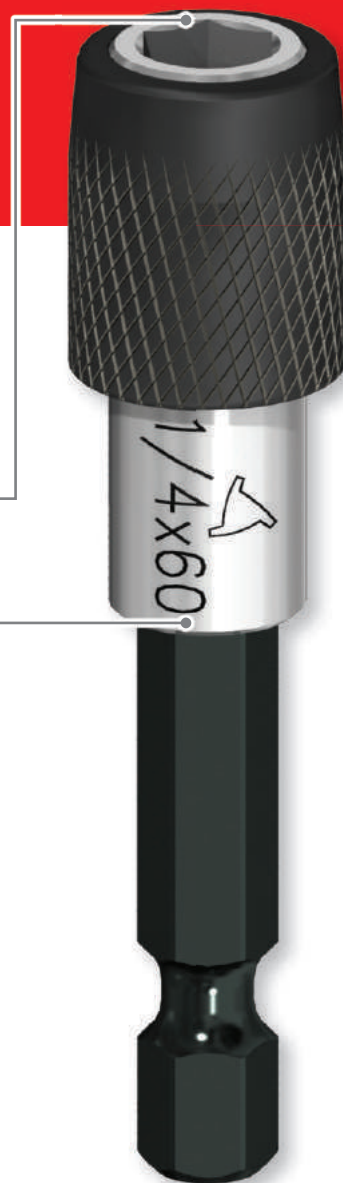

Utilizamos matérias-primas de alta qualidade no fabrico dos nossos suportes de BIT'S, tal como das BIT'S.

Our bit holders and bits are made using raw materials of the highest quality.



Concebido para funcionar melhor em conjunto com todas as BIT'S da gama LTI.

Designed to work best in combination with LTI range bits.



Uma ampla escolha de soluções para tornar qualquer operação de montagem mais fácil.

Wide range of solutions to make any assembly operation easier.

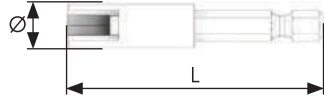
**62013****MAGNÉTICOS SEM ANEL**SUPORTE DE BIT'S 1/4"E MAGNÉTICO PARA BIT'S 1/4"C
MAGNETIC 1/4"E BIT-HOLDER FOR 1/4"C BITS**EASYPACK** | caixa PVC com Euro-hole /PVC bags with Euro-hole

L mm	Ø mm	UN.	CÓD.	€ box
50	10	2	62013004	
60	10	2	62013005	
75	10	2	62013010	
100	10	2	62013015	
120	10	2	62013020	
150	10	2	62013025	
200	10	2	62013030	
250	10	2	62013035	

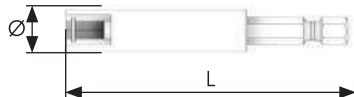
62015**MAGNÉTICOS COM ANEL**SUPORTE DE BIT'S MAGNÉTICO COM ANEL C 1/4"E PARA BIT'S 1/4"C
MAGNETIC 1/4"E BIT-HOLDER WITH C-RING FOR 1/4"C BITS**EASYPACK** | caixa PVC com Euro-hole /PVC bags with Euro-hole

L mm	Ø mm	UN.	CÓD.	€ box
50	10	2	62015005	
60	10	2	62015010	
75	10	2	62015015	
100	10	2	62015020	
120	9,8	2	62015025	
150	10	2	62015030	
200	9,8	2	62015035	
250	11	2	62015040	
400	11	2	62015070	

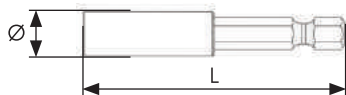
62015**SUPORTE DE BIT'S INX**SUPORTE DE BIT'S 1/4"E EM AÇO INOXIDÁVEL INTEGRAL MAGNÉTICO COM ANEL
PARA BIT'S 1/4"C
1/4"E STAINLESS STEEL BIT HOLDER WITH C-RING AND MAGNET FOR 1/42C BITS**NEW!****EASYPACK** | caixa PVC com Euro-hole /PVC bags with Euro-hole

L mm	Ø mm	UN.	CÓD.	€ box
60	11	2	62015105002	



SUPORE DE BIT'S

BIT HOLDERS

62016

MANDRIL DE BLOQUEIO

SUPORE DE BIT'S 1/4\"/>

EASYPACK | caixa PVC com Euro-hole PVC bags with Euro-hole

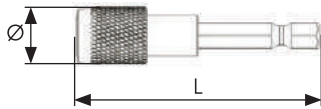

L mm	UN.	CÓD.	€ box
60	2	62016005002	



FOCUS ON

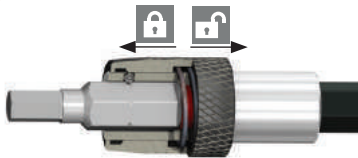

As esferas de vedação bloqueiam a ponta: este artigo é recomendado para utilização com Bit's sextavadas que tendem a bloquear na fenda do parafuso.

The sealing balls block the bit: this article is recommended for use with hexagon bits that tend to become blocked in the slot of the screw.



62016

SUPORE DE BIT'S INX

MANDRIL DE BLOQUEIO



SUPORE DE BIT'S 1/4\"/>

EASYPACK | caixa PVC com Euro-hole PVC bags with Euro-hole

NEW!

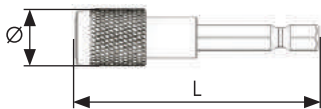

L mm	Ø mm	UN.	CÓD.	€ box
60	14	2	62016105002	

FOCUS ON

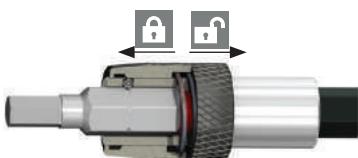

As esferas de vedação bloqueiam a ponta: este artigo é recomendado para utilização com Bit's sextavadas que tendem a bloquear na fenda do parafuso.

The sealing balls block the bit: this article is recommended for use with hexagon bits that tend to become blocked in the slot of the screw.





62017

ÍMAN DUPLO BATENTE FIXO

SUPOORTE DE BIT'S 1/4" E COM ÍMAN PARA RETENÇÃO DO PARAFUSO
PARA BIT'S 1/4" C
1/4" E BIT-HOLDER WITH MAGNET FOR SCREW RETENTION FOR 1/4" C BITS

EASYPACK | caixa PVC com Euro-hole PVC bags with Euro-hole



L mm	Ø mm	UN.	CÓD.	€ box
60	15	2	62017005002	



FOCUS ON

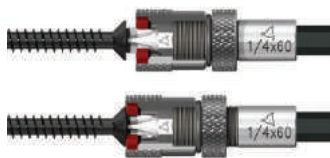

Íman de anel para a cabeça do parafuso, profundidade de aparafusamento ajustável através da porca de anel, ideal para a instalação de gesso cartonado.

Ring magnets for the head of the screw, screwing depth can be adjusted via the ring nut, which makes it ideal for plasterboard.



62018

ARTICULADOS

SUPOORTE DE BIT'S 1/4" E ARTICULADO COM BLOQUEIO PARA BIT'S 1/4" C
ARTICULATED 1/4" E BIT HOLDER WITH LOCK FOR 1/4" C BITS

EASYPACK | caixa PVC com Euro-hole PVC bags with Euro-hole



L mm	Ø mm	UN.	CÓD.	€ box
94	14	2	62018005002	



FOCUS ON



Ideal para trabalhar em espaços pequenos ou desconfortáveis onde não é possível aparafusar na direção do eixo do parafuso. Movendo a porca de anel, pode trabalhar na posição direita.

Ideal for working in tight or difficult spaces where a second screw cannot be inserted. Move the ring nut to work in a straight position.





SUPORE DE BIT'S

BIT HOLDERS

64221

MINI-CHAVE ROQUETE REVERSÍVEL

MINI-CHAVE ROQUETE SUPORTE DE BIT'S REVERSÍVEL PARA BIT'S 1/4\"/>

NEW!

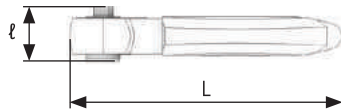

L mm	l mm	UN.	CÓD.	€ cad./each
85	12,5	1	64221030	

62029

CHAVE DE FENDAS SUPORTE DE BIT'S MAGNÉTICOS

CHAVE DE FENDAS MAGNÉTICA PARA BIT'S 1/4\"/>

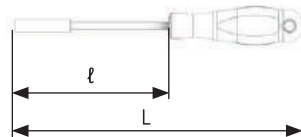

L mm	l mm	UN.	CÓD.	€ cad./each
215	100	1	62029005	

62029

CHAVE DE FENDAS SUPORTE DE BIT'S MAGNÉTICOS FLEXÍVEIS

CHAVE DE FENDAS MAGNÉTICA FLEXÍVEL PARA BIT'S 1/4\"/>

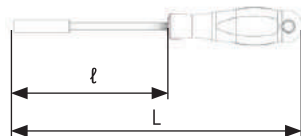

L mm	l mm	UN.	CÓD.	€ cad./each
350	250	1	62029010	





62055 SUPER-FLEXÍVEIS

SUPORE DE BIT'S 1/4"E SUPER-FLEXÍVEL PARA BIT'S 1/4"C
EXTRA-FLEXIBLE 1/4"E BIT-HOLDER FOR 1/4"C BITS

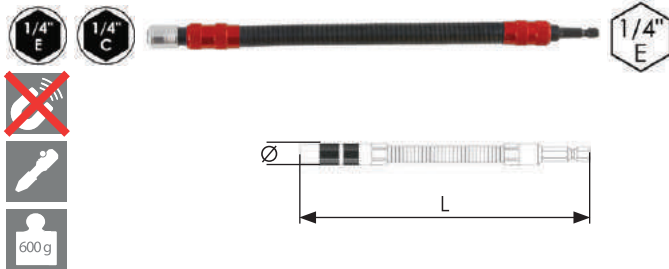

EASYPACK | caixa PVC com Euro-hole PVC bags with Euro-hole

L mm	Ø mm	UN.	CÓD.	€ cad./each
300	16	1	62055005	

! FOCUS ON

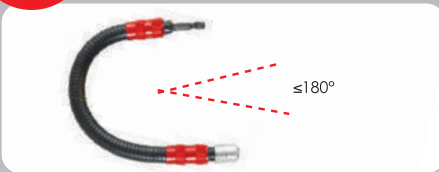

Graças à sua extrema flexibilidade, são perfeitos para trabalhar em espaços de difícil acesso.

Its extreme flexibility is perfect for working in difficult positions or to reach narrow spaces.



62025 ENGATE QUADRADO 1/4" COM ESFERA

SUPORE DE BIT'S 1/4" COM ESFERA PARA BIT'S 1/4"C
1/4" BIT-HOLDER WITH BALL FOR 1/4"C BITS

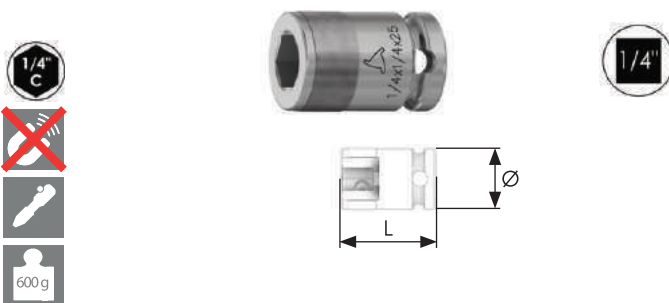

EASYPACK | caixa PVC com Euro-hole PVC bags with Euro-hole

L mm	Ø mm	UN.	CÓD.	€ box
25	12	2	62025010002	



SUPORE DE BIT'S

BIT HOLDERS

62027

ENGATE QUADRADO 3/8\"/>

SUPORE DE BIT'S COM ESFERA 3/8\"/>

EASYPACK | caixa PVC com Euro-hole PVC bags with Euro-hole



L mm	Ø mm	UN.	CÓD.	€ box
28	17	2	62027010002	

62031

ENGATE QUADRO 1/2\"/>

SUPORE DE BIT'S 1/2\"/>

EASYPACK | caixa PVC com Euro-hole PVC bags with Euro-hole



L mm	Ø mm	UN.	CÓD.	€ box
38	22	2	62031010002	



COMO ESCOLHER O SUPORTE DE BIT'S

HOW TO CHOOSE A BIT HOLDER

NÃO MAGNÉTICOS Non-magnetic

RECOMENDADO



Quando se trabalha na presença de limalhas, pó ou aparas.

For working in the presence of filings, dust or iron shavings.

ÍMAN DUPLO Double magnets

RECOMENDADO



Com parafusos grandes ou compridos (parafusos para coberturas de edifícios).

With large or long screws (screws for building roofs).

DESENGATE RÁPIDO Quick release

RECOMENDADO

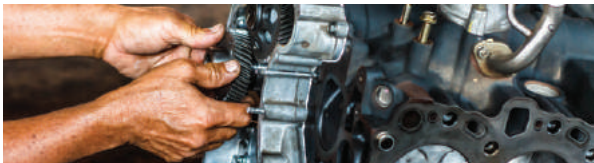

Se tiverem de ser usadas luvas ou se as mãos estiverem sujas de óleo.

If you have to wear gloves or if your hands are oily.

ARTICULADOS OU FLEXÍVEIS Jointed or flexible

RECOMENDADO



Perto de uma aresta (rodapés, móveis, gavetas, motores de automóveis, guardalamas).

Close to an edge (skirting boards, furniture, drawers, car engines, mudguards).

MANDRIL DE BLOQUEIO Chuck

RECOMENDADO



Se a ponta bloquear na fenda do parafuso, se o ponto onde o parafuso deve ser posicionado for difícil de alcançar.

If the bit becomes stuck in the slot of the screw, if the point where the screw is to be positioned is difficult to reach.

SOQUETES MAGNÉTICOS Magnetic sockets

RECOMENDADO



No caso de furos profundos ou alojamentos particularmente estreitos.

In case of deep holes or particularly tight seats.

CABEÇOTES ANGULARES

CABEÇOTES ANGULARES PARA BIT'S 1/4" C E BIT'S 1/4" E

Angle heads for 1/4" C bits and 1/4" E power-bits



INDUSTRIAL

1

Engrenagens da junta com par cônico hipóide.

Gear coupling with hypoid bevel gear pair.

2

Guias do eixo temperadas e retificadas

Hardened and ground shaft guide.

3

Resistência garantida ao esforço de torção acima de 65 Nm.

Resistance to torsional stress is guaranteed at over 65 Nm.



TIPS

Não utilize com chaves de impacto
Do not use with impact wrenches

PROFESSIONAL

1

Engrenagens da junta com par cônico simples.

Gear coupling with simple bevel gear pair.

2

Cabeça rebaixada, pega pivotante e/ou removível.

Low-rise head, pivoting and/or extractable handle.

3

Resistência garantida ao esforço de torção até 40 Nm.

Resistance to torsional stress is guaranteed up to 40 Nm.



TIPS

Não utilize com chaves de impacto
Do not use with impact wrenches





62034 CABEÇOTES ANGULARES 90° INDUSTRIAIS

CABEÇOTE ANGULAR 90° PARA BIT'S 1/4" C - ALTA RESISTÊNCIA - INDUSTRIAL
90° ANGLE DRIVER FOR 1/4" C BITS - HIGH RESISTANCE - INDUSTRIAL

65 Nm

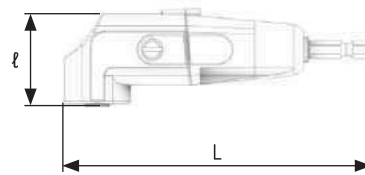

L mm	l mm	UN.	CÓD.	€ cad./each
125	37	1	62034006	



77 X 175 mm



FOCUS ON



Rolamentos de alta qualidade, eixos temperados retificados, par cônico hipóide para uma rotação suave. Ferramenta adequada para usos industriais intensivos. Fácil manutenção.
High quality bearings, ground tempered shafts, hypoid bevel coupling for smooth rotation. Tool suitable for heavy-duty industrial use. Easy maintenance.



62034 MINI-CABEÇOTES ANGULARES 90° PROFISSIONAIS

CABEÇOTE ANGULAR 90° COM MANDRIL DE BLOQUEIO PARA BIT'S 1/4" C
90° ANGLE DRIVER WITH CHUCK FOR 1/4" C BITS

40 Nm

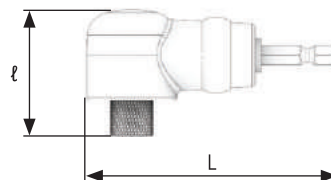

L mm	l mm	UN.	CÓD.	€ cad./each
83	46	1	62034010	



85 X 190 mm



FOCUS ON



Prático e compacto com pega pivotante, que pode ser trancada em 8 posições diferentes, é fornecido com uma ponta PH2x25, embalada em blister.
Compact and practical, with pivoting handle that can be locked in eight different positions. Comes with a PH2x25 bit in a blister pack.





CABEÇOTES ANGULARES

ANGLE HEADS

62180

CABEÇOTES ANGULARES 90° PROFISSIONAIS PARA BIT'S

CABEÇOTE COM ÂNGULO 90° COM MANDRIL AUTOBLOCANTE PARA BIT'S
90° ANGLE DRIVER WITH SELF-LOCKING CHUCK FOR DRILL BITS

EASYPACK | caixa PVC com Euro-hole PVC bags with Euro-hole

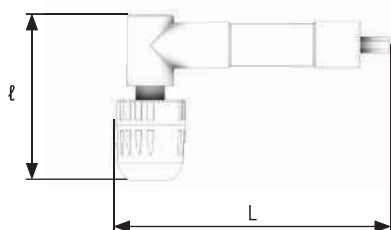
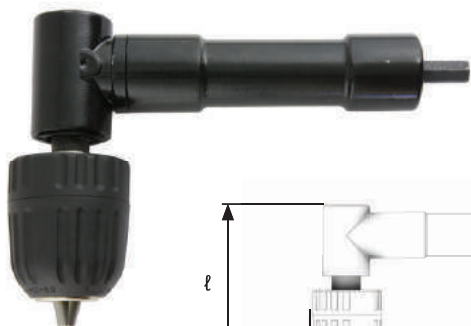

Ø	L mm	ℓ mm	UN.	CÓD.	€ cad./each
1,5-10	155	100	1	62180006	



65011

MAGNETIZADORES DESMAGNETIZADORES

BLOCO MAGNETIZADOR/DESMAGNETIZADOR PARA CHAVE DE FENDAS
MAGNETIZER / DEMAGNETIZER FOR SCREWDRIVERS

EASYPACK | caixa PVC com Euro-hole PVC bags with Euro-hole



L mm	ℓ mm	UN.	CÓD.	€ cad./each
54	49	1	65011005	



FOCUS ON



Ideal para magnetizar temporariamente chaves de fendas e bit's de aparafusamento. Insira a ponta na respetiva fenda durante alguns segundos. Para desmagnetizar, insira a ponta na outra fenda.

Ideal to temporarily magnetize screwdrivers and screwing blades. Insert the tip into the slot for a few seconds. To demagnetize, insert the tip into the other slot.





*Depósito de armazenamento e produção LTI nas instalações da Krino.
LTI customized products stock in Krino site.*

ADAPTADORES

ADAPTADORES PARA CHAVES DE CAIXA 1/4" C E 1/4" E

Adapters for 1/4" C and 1/4" E sockets

A = de acordo com a DIN 3121 Forma E, com pino de retenção em aço para molas. Adequados para utilização com soquetes IMPACT; o pino garante o bloqueio do soquete, evitando que se perca, mesmo em instalações automáticas.

A = according to DIN 3121 Form E Standard, with retention pin in spring steel. Suitable for use with IMPACT sockets; the pin ensures the locking of the socket, preventing loss even on automatic systems.

B = de acordo com a DIN 3120 Forma A, com esfera de aço. Adequados para utilização com soquetes CHROME; a esfera facilita a colocação e remoção do soquete.

B = according to DIN 3120 Form A Standard, with steel ball. Suitable for use with CHROME sockets; the ball facilitates assembly and disassembly of the socket.

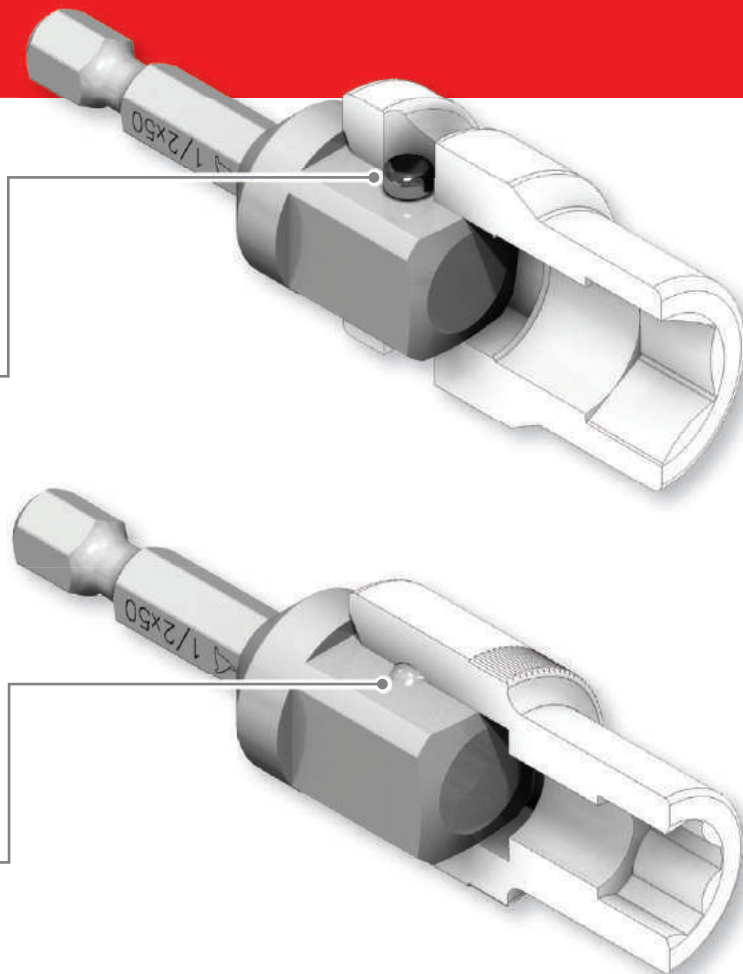

Fabricados com o mesmo aço de alta qualidade utilizado nas Bit's, que oferece um excelente equilíbrio entre dureza e resistência.

Made with the same high-quality steel used for the bits, which provides an excellent combination of hardness and toughness.



Concebidos para o máximo desempenho em combinação com soquetes IMPACT e CHROME da gama LTI.

Designed for maximum performance in combination with IMPACT and CHROME sockets from the LTI range.



A gama também inclui a versão com engate SDS PLUS, utilizada em berbequins percutores para o setor da construção.

The range also includes the version with SDS PLUS attachment for use on hammer drills in the construction industry.



62101 ADAPTADORES 1/4"E PARA CHAVES DE CAIXA 1/4"

ADAPTADOR 1/4"E PARA CHAVES DE CAIXA 1/4"
1/4"E ADAPTER FOR 1/4" SOCKETS

EASYPACK | caixa PVC com Euro-hole PVC bags with Euro-hole

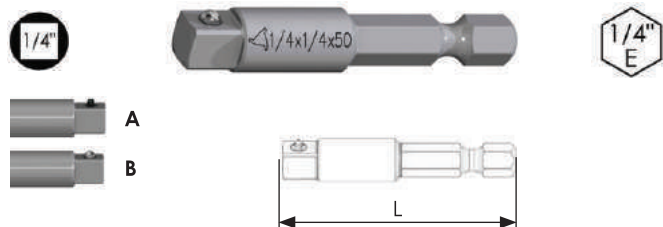

L mm	A/B/C	UN.	CÓD.	€ box
50	A	2	62101005002	
50	B	2	62101010002	
100	A	2	62101015002	
100	B	2	62101020002	

62111 ADAPTADORES 1/4"E PARA SOQUETES 3/8"

ADAPTADOR 1/4"E PARA SOQUETES 3/8"
1/4"E ADAPTER FOR 3/8" SOCKETS

EASYPACK | caixa PVC com Euro-hole PVC bags with Euro-hole

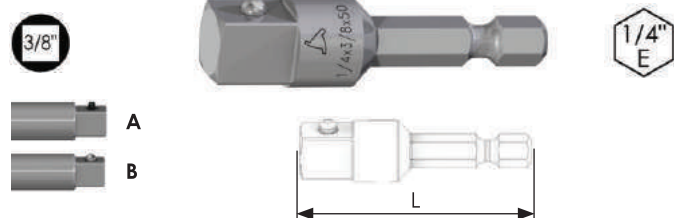

L mm	A/B	UN.	CÓD.	€ box
50	A	2	62111005002	
50	B	2	62111010002	

62121 ADAPTADORES 1/4"E PARA SOQUETES 1/2"

ADAPTADOR 1/4"E PARA SOQUETES 1/2"
1/4"E ADAPTER FOR 1/2" SOCKETS

EASYPACK | caixa PVC com Euro-hole PVC bags with Euro-hole

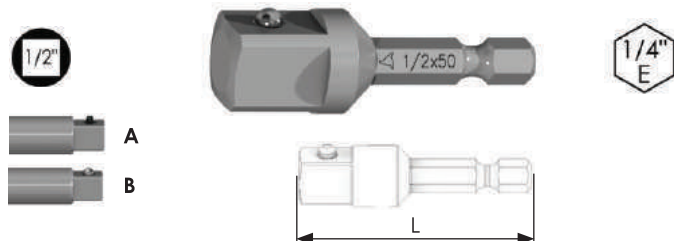

L mm	A/B	UN.	CÓD.	€ box
50	A	2	62121005	
50	B	2	62121006	



ADAPTADORES

ADAPTERS

62601 CONJUNTO 3 ADAPTADORES

CONJUNTO DE 3 ADAPTADORES PARA CHAVES DE CAIXA 1/4", 3/8" E 1/2"
3 UN. ADAPTERS SET FOR 1/4", 3/8" AND 1/2" SOCKETS

EASYPACK | caixa PVC com Euro-hole | PVC bags with Euro-hole

A/B	UN.	CÓD.	€ cad./each
B	1	62601001	



95 X 145 mm



EURO-HOLE



Instalação de sistemas em teto falso.
Installation of systems in a false ceiling.



62103 ADAPTADORES SDS PLUS® PARA CHAVES DE CAIXA 1/4"

ADAPTADOR SDS-PLUS® PARA CHAVES DE CAIXA 1/4"
SDS PLUS® ADAPTER FOR 1/4" SOCKETS

EASYPACK | caixa PVC com Euro-hole / PVC bags with Euro-hole

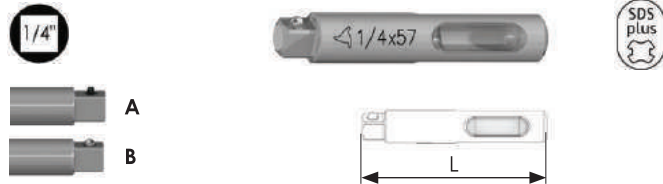

L mm	A/B	UN.	CÓD.	€ box
57	B	2	62103005002	

62113 ADAPTADORES SDS PLUS® PARA CHAVES DE CAIXA 3/8"

ADAPTADOR SDS-PLUS® PARA CHAVES DE CAIXA 3/8"
SDS PLUS® ADAPTER FOR 3/8" SOCKETS

EASYPACK | caixa PVC com Euro-hole / PVC bags with Euro-hole

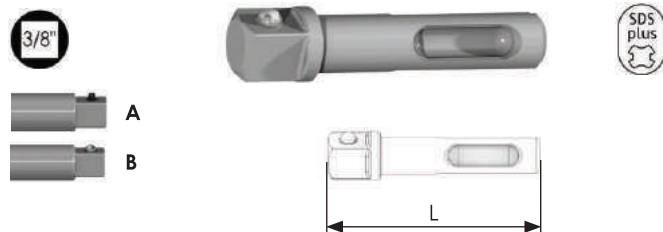

L mm	A/B	UN.	CÓD.	€ box
60	B	2	62113005002	

62122 ADAPTADORES SDS PLUS® PARA CHAVES DE CAIXA 1/2"

ADAPTADOR SDS-PLUS® PARA CHAVES DE CAIXA 1/2"
SDS PLUS® ADAPTER FOR 1/2" SOCKETS

EASYPACK | caixa PVC com Euro-hole / PVC bags with Euro-hole

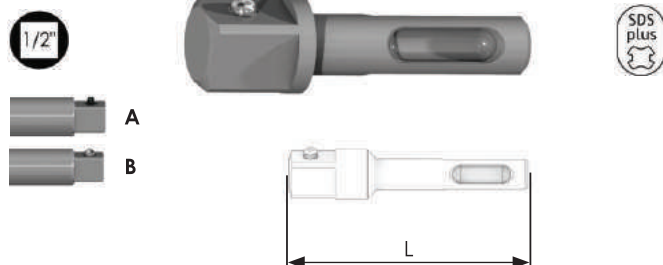

L mm	A/B	UN.	CÓD.	€ box
65	B	2	62122005002	

ADAPTADORES

ADAPTERS



62151 ADAPTADORES 1/4" E PARA MANDRIS

ADAPTADORES 1/4" E PARA MANDRIS, COM PARAFUSO DE BLOQUEIO À ESQUERDA
1/4" E ADAPTERS FOR CHUCKS, WITH LEFT BLOCK SCREWS

EASYPACK | caixa PVC com Euro-hole PVC bags with Euro-hole

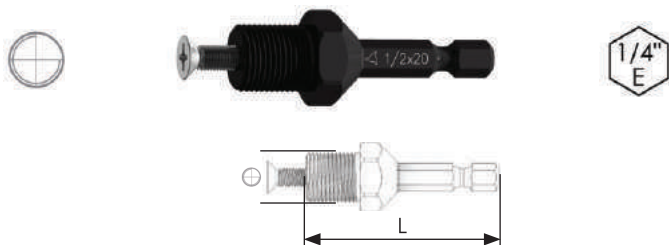

	L mm	UN.	CÓD.	€ box
3/8"x24	50	2	62151005	
1/2"x20	50	2	62151010	

62152 ADAPTADORES SDS-PLUS PARA MANDRIS

ADAPTADORES SDS-PLUS PARA MANDRIS, COM PARAFUSO DE BLOQUEIO À ESQUERDA
SDS-PLUS ADAPTERS FOR CHUCKS, WITH LEFT BLOCK SCREWS

EASYPACK | caixa PVC com Euro-hole PVC bags with Euro-hole

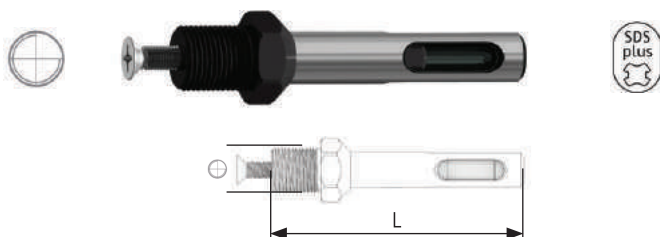

	L mm	UN.	CÓD.	€ box
1/2"X20	65	2	62152005002	



FOCUS ON

CORROSÃO

Os aços inoxidáveis são ligas de ferro caracterizadas não apenas pelas propriedades mecânicas típicas dos aços carbono, mas também por uma notável resistência à corrosão. Esta capacidade deve-se à presença de elementos de liga, principalmente o cromo, que são capazes de se revestir com uma camada aderente e invisível de óxidos que protege o metal subjacente da ação de agentes químicos externos (água, sal, outros metais, etc.). Os principais tipos de corrosão a que o aço inoxidável está sujeito são a corrosão em ambiente salino (corrosão salina) e a corrosão devido à contaminação por outros metais (corrosão galvânica).

É precisamente por esta razão que é preferível utilizar Bit's de aço inoxidável com parafusos de aço inoxidável ou, se tal não for possível, interpor

material isolante entre os mesmos.

CORROSION

Stainless steels are iron alloys characterised not only by the typical mechanical properties of carbon steel, but also by a remarkable resistance to corrosion. This ability comes from the presence of alloy elements, primarily chromium, which are able to cover themselves with an adhering and invisible oxide layer that protects the underlying metal against the action of external chemical agents (water, salt, other metals, etc.). STAINLESS steel is particularly prone to corrosion in saline environments (saline corrosion) or corrosion caused by contamination with other metals (galvanic corrosion). For this last reason, it is preferable to use STAINLESS STEEL BITS with STAINLESS STEEL screws or, if this is not possible, to place insulating material between them.

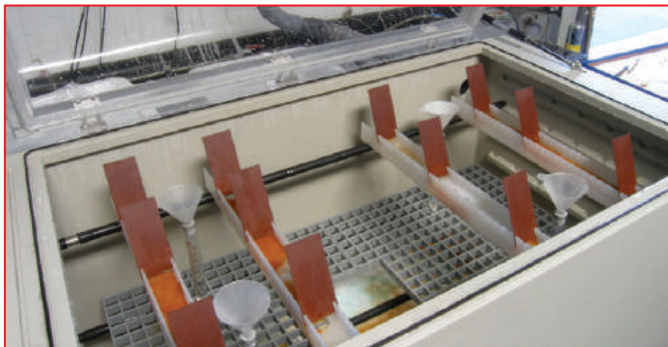

Câmara para teste de corrosão do aço inoxidável em nevoeiro salino.
Chamber for STAINLESS STEEL corrosion tests in a saline mist.



Exemplo de corrosão galvânica causada pelo acoplamento de porcas e parafusos de aço inoxidável numa placa de aço.
Example of galvanic corrosion caused by combining stainless steel details on a steel plate.

BIT'S E CHAVES ESPECIAIS

BIT'S E CHAVES ESPECIAIS PARA A INDÚSTRIA, AUTOMAÇÃO E MANUTENÇÃO

Special bits and setters for the industrial, automation and maintenance sectors.

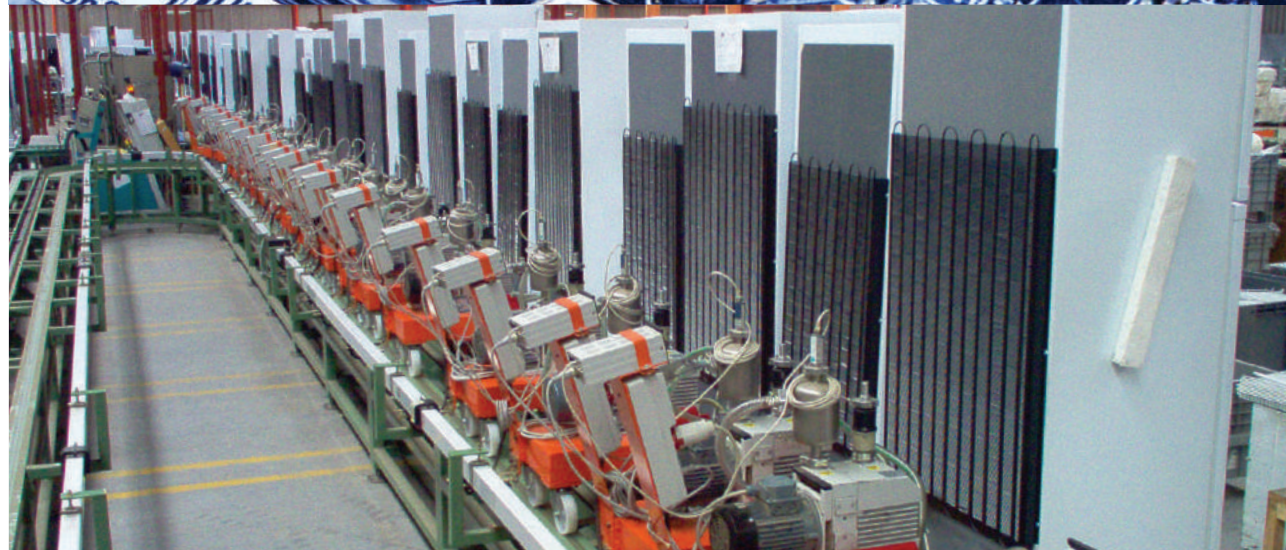
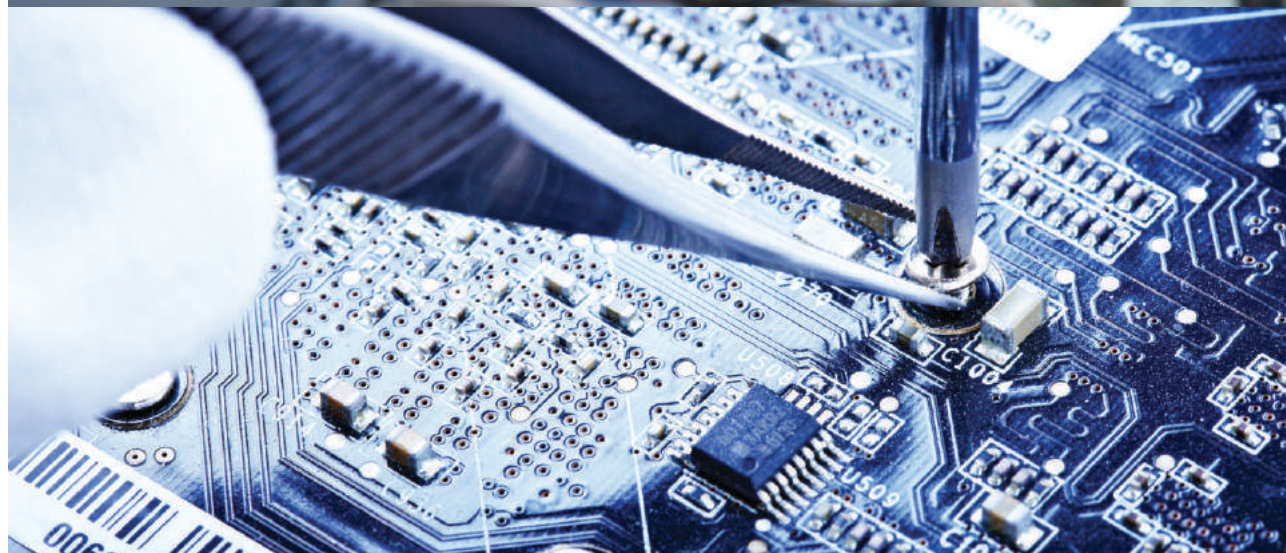

1

No setor mecânico, para a produção e reparação de motores, e da construção naval, onde são necessários parafusos de grande diâmetro e alto desempenho, são utilizadas Bit's com engate maior e perfis de 6 e 12 lóbulos para permitir uma melhor distribuição do binário. Um aço crômio-silício-vanádio apropriado garante uma elevada resistência e maior elasticidade.

Bits with larger attachments and tips with 6 and 12 lobes, which provide better distribution of the tightening torque, are commonly used in the mechanical industry for the production and repair of engines, and in shipbuilding yards. These areas require the use of fasteners with wide diameters and high performances. Chrome-silicon-vanadium steel guarantees high resistance and greater elasticity.

2

Os dispositivos eletrônicos estão agora nas mãos de todos e, com eles, os microparafusos estão generalizados. A prerrogativa deste tipo de fixadores é a extrema precisão: é muito fácil danificar o perfil ou a rosca. Para este tipo de aplicação, selecionámos uma série de Bit's com os perfis mais comuns, realizadas com aço especial, extremamente resistente, para evitar deformações no perfil que poderiam danificar a fenda do parafuso.

Suitable for the production of electronic devices where micro-screws are widely used. The special feature of this type of fastener is its extreme precision: it is very easy to ruin the tip or thread. For these types of applications, we selected a series of bits with more common tips, made with special, extremely strong, steel to prevent deformations of the tip that might damage the slot of the screw.

3

A produção de ferramentas para aplicações industriais e instalações de montagem automatizadas é certamente uma área em que a marca LTI sempre se destacou. Graças a esta especificidade, que sempre foi apreciada pelos nossos clientes, introduzimos a cada dois dias um novo código de produto. Por conseguinte, selecionámos uma gama de ferramentas industriais que estão sempre em stock e têm um preço de tabela fixo independentemente da quantidade, colocando a máxima atenção na qualidade para assegurar a máxima fiabilidade.

The LTI brand has always been a pioneer in the production of tools for industrial applications and for automated assembly systems. For this case, we also offer a range of industrial tools that are always in stock, placing maximum attention on the construction to guarantee maximum reliability.



BIT'S E CHAVES ESPECIAIS

BITS AND SPECIAL SETTERS

61011

SEXTAVADO 10mm (3/8")

BIT'S 10mm (3/8") SEXTAVADAS PARA O SETOR MECÂNICO
10mm (3/8") HEX BITS FOR MECHANICS

56/58 HRC

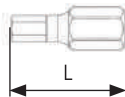

EASYPACK | caixa PVC com Euro-hole PVC bags with Euro-hole

Ø	L mm	UN.	CÓD.	€ box
4	30	5	61011005005	
	75	5	61011010005	
5	30	5	61011015005	
	75	5	61011020005	
6	30	5	61011025005	
	75	5	61011030005	
7	30	5	61011035005	
	75	5	61011040005	
8	30	5	61011045005	
	75	5	61011050005	
10	30	5	61011055005	
	75	5	61011060005	
12	30	5	61011065005	
	75	5	61011070005	
14	30	5	61011075005	
	75	5	61011080005	

61129

XZN - 10mm (3/8")

BIT'S 10mm (3/8") PARA PARAFUSOS XZN PARA O SETOR MECÂNICO
10mm (3/8") BITS FOR XZN MECHANICAL SCREWS

56/58 HRC

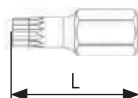

EASYPACK | caixa PVC com Euro-hole PVC bags with Euro-hole

Ø	L mm	UN.	CÓD.	€ box
M5	30	5	61129005005	
	75	5	61129010005	
M6	30	5	61129015005	
	75	5	61129020005	
M8	30	5	61129025005	
	75	5	61129030005	
M10	30	5	61129035005	
	75	5	61129040005	
M12	30	5	61129045005	
	75	5	61129050005	
M14	30	5	61129055005	
	75	5	61129060005	



61100 TX - 10mm (3/8")

BIT'S 10mm (3/8") PARA PARAFUSOS TORX® PARA O SETOR MECÂNICO
10mm (3/8") BITS FOR TORX® MECHANICAL SCREWS

56/58 HRC

EASYPACK | caixa PVC com Euro-hole PVC bags with Euro-hole

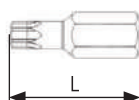

	L mm	UN.	CÓD.	€ box
TX10	30	5	61100005	
	75	5	61100010	
TX15	30	5	61100015	
	75	5	61100020	
TX20	30	5	61100025	
	75	5	61100030	
TX25	30	5	61100035	
	75	5	61100040	
TX27	30	5	61100045	
	75	5	61100050	
TX30	30	5	61100055	
	75	5	61100060	
TX40	30	5	61100065	
	75	5	61100070	
TX45	30	5	61100075	
	75	5	61100080	
TX50	30	5	61100085	
	75	5	61100090	
TX55	30	5	61100095	
	75	5	61100100	

61114 TXH COM ORIFÍCIO 10mm (3/8")

BIT'S 10mm (3/8") PARA PARAFUSOS TORX® COM ORIFÍCIO PARA O SETOR MECÂNICO
10mm (3/8") BITS FOR TORX® MECHANICAL SCREWS

56/58 HRC

EASYPACK | caixa PVC com Euro-hole PVC bags with Euro-hole

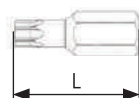

	L mm	UN.	CÓD.	€ box
TXH10	30	5	61114005005	
	75	5	61114010005	
TXH15	30	5	61114015005	
	75	5	61114020005	
TXH20	30	5	61114025005	
	75	5	61114030005	
TXH25	30	5	61114035005	
	75	5	61114040005	
TXH27	30	5	61114045005	
	75	5	61114050005	
TXH30	30	5	61114055005	
	75	5	61114060005	
TXH40	30	5	61114065005	
	75	5	61114070005	
TXH45	30	5	61114075005	
	75	5	61114080005	
TXH50	30	5	61114085005	
	75	5	61114090005	
TXH55	30	5	61114095005	
	75	5	61114100005	



BIT'S E CHAVES ESPECIAIS

BITS AND SPECIAL SETTERS

61128

RIBE - 10mm (3/8")

BIT'S 10mm (3/8") PARA PARAFUSOS RIBE® PARA O SETOR MECÂNICO
10mm (3/8") BITS FOR RIBE® MECHANICAL SCREWS

56/58 HRC

EASYPACK | caixa PVC com Euro-hole PVC bags with Euro-hole

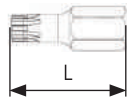

	L mm	UN.	CÓD.	€ box
M4	30	5	61128005005	
	75	5	61128010005	
M5	30	5	61128015005	
	75	5	61128020005	
M6	30	5	61128025005	
	75	5	61128030005	
M7	30	5	61128035005	
	75	5	61128040005	
M8	30	5	61128045005	
	75	5	61128050005	
M9	30	5	61128055005	
	75	5	61128060005	
M10	30	5	61128065005	
	75	5	61128070005	
M12	30	5	61128075005	
	75	5	61128080005	
M13	30	5	61128085005	
	75	5	61128090005	
M14	30	5	61128095005	
	75	5	61128100005	
M16	30	5	61128105005	
	75	5	61128110005	

61127

RIBE H - 10mm (3/8")

BIT'S 10mm (3/8") PARA PARAFUSOS RIBE® COM ORIFÍCIO PARA O SETOR MECÂNICO
10mm (3/8") BITS FOR RIBE® MECHANICAL SCREWS WITH HOLE

56/58 HRC

EASYPACK | caixa PVC com Euro-hole PVC bags with Euro-hole

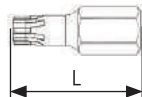

	L mm	UN.	CÓD.	€ box
MH5	30	5	61127005005	
	75	5	61127010005	
MH6	30	5	61127015005	
	75	5	61127020005	
MH7	30	5	61127025005	
	75	5	61127030005	
MH8	30	5	61127035005	
	75	5	61127040005	
MH9	30	5	61127045005	
	75	5	61127050005	
MH10	30	5	61127055005	
	75	5	61127060005	
MH12	30	5	61127065005	
	75	5	61127070005	



62081

SUPORE DE BIT'S 3/8" COM ESFERA

SUPORE DE BIT'S 3/8" COM ESFERA PARA BIT'S 10mm
3/8" BIT-HOLDER WITH BALL FOR 10mm BITS

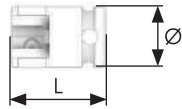

EASYPACK | caixa PVC com Euro-hole PVC bags with Euro-hole

L mm	Ø mm	UN.	CÓD.	€ box
30	17	2	62081005002	

62083

SUPORE DE BIT'S 1/2" COM ESFERA

SUPORE DE BIT'S 1/2" COM ESFERA PARA BIT'S 10mm
1/2" BIT-HOLDER WITH BALL FOR 10mm BITS



EASYPACK | caixa PVC com Euro-hole PVC bags with Euro-hole

L mm	Ø mm	UN.	CÓD.	€ box
36	22	2	62083005002	



BIT'S E CHAVES ESPECIAIS

BITS AND SPECIAL SETTERS

66013

JOGO BIT'S 10mm (3/8") TX/TXH

CONJUNTO 22 UN. BIT'S 10mm (3/8")
SET OF 22 BITS 10mm (3/8")



22
un.

282 X 35 X 130 mm

CÓD. **66013005**

61100x30mm

TX10	TX15	TX20	TX25	TX27	TX30	TX40	TX45	TX50	TX55
1 un.	1 un.	1 un.	1 un.	1 un.	1 un.	1 un.	1 un.	1 un.	1 un.

61100x75mm

TX10	TX15	TX20	TX25	TX27	TX30	TX40	TX45	TX50	TX55
1 un.	1 un.	1 un.	1 un.	1 un.	1 un.	1 un.	1 un.	1 un.	1 un.

CÓD. **66013010**

61114x30mm

TXH10	TXH15	TXH20	TXH25	TXH27	TXH30	TXH40	TXH45	TXH50	TXH55
1 un.	1 un.	1 un.	1 un.	1 un.	1 un.	1 un.	1 un.	1 un.	1 un.

61114x75mm

TXH10	TXH15	TXH20	TXH25	TXH27	TXH30	TXH40	TXH45	TXH50	TXH55
1 un.	1 un.	1 un.	1 un.	1 un.	1 un.	1 un.	1 un.	1 un.	1 un.

INCLUÍDO / INCLUDED

CÓD. 62081005002



CÓD. 62083005002



66013

JOGO BIT'S 10mm (3/8") RIBE

CONJUNTO 20 UN. BIT'S 10mm (3/8")
SET OF 20 BITS 10mm (3/8")



20
un.

282 X 35 X 130 mm

CÓD. **66013015**

61128x30mm

M6	M7	M8	M9	M10	M12	M13	M14	M16
1 un.	1 un.	1 un.	1 un.	1 un.	1 un.	1 un.	1 un.	1 un.

61128x75mm

M6	M7	M8	M9	M10	M12	M13	M14	M16
1 un.	1 un.	1 un.	1 un.	1 un.	1 un.	1 un.	1 un.	1 un.

INCLUÍDO / INCLUDED

CÓD. 62081005002



CÓD. 62083005002





66013 JOGO BIT'S 10mm (3/8")

CONJUNTO 40 UN. BIT'S 10mm (3/8")
SET OF 40 BITS 10mm (3/8")

CÓD. **66013016**



40 un.

320 X 35 X 150 mm

INCLUÍDO / INCLUDED

CÓD. 62081005002



CÓD. 62083005002



61100x30mm						
TX20	TX25	TX30	TX40	TX45	TX50	TX55
1 un.	1 un.	1 un.	1 un.	1 un.	1 un.	1 un.
61128x30mm						
M5	M6	M7	M8	M9	M10	M12
1 un.	1 un.	1 un.	1 un.	1 un.	1 un.	1 un.
61129x30mm						
M5	M6	M8	M10	M12		
1 un.	1 un.	1 un.	1 un.	1 un.	1 un.	
61100x75mm						
TX20	TX25	TX30	TX40	TX45	TX50	TX55
1 un.	1 un.	1 un.	1 un.	1 un.	1 un.	1 un.
61128x75mm						
M5	M6	M7	M8	M9	M10	M12
1 un.	1 un.	1 un.	1 un.	1 un.	1 un.	1 un.
61129x75mm						
M5	M6	M8	M10	M12		
1 un.	1 un.	1 un.	1 un.	1 un.	1 un.	



BIT'S E CHAVES ESPECIAIS

BITS AND SPECIAL SETTERS

61140

PH - 4mm (5/32"-C4)

BIT'S 4mm (5/32" C) PARA MICROPARAFUSOS PHILLIPS®
4mm (5/32" C) BITS FOR PHILLIPS® MICRO-SCREWS

58/60 HRC

EASYPACK | caixa PVC com Euro-hole #PVC bags with Euro-hole



	L mm	UN.	CÓD.	€ box
PH000	28	5	61140001005	
PH00	28	5	61140002005	
PH0	28	5	61140005005	
PH1	28	5	61140010005	
PH2	28	5	61140020005	

61142

TX - 4mm (5/32"-C4)

BIT'S 4mm (5/32" C) PARA MICROPARAFUSOS TORX®
4mm (5/32" C) BITS FOR TORX® MICRO-SCREWS

58/60 HRC

EASYPACK | caixa PVC com Euro-hole #PVC bags with Euro-hole

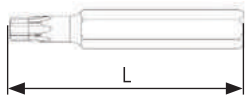

	L mm	UN.	CÓD.	€ box
TX03	28	5	61142005005	
TX04	28	5	61142010005	
TX05	28	5	61142015005	
TX06	28	5	61142020005	
TX07	28	5	61142025005	
TX08	28	5	61142030005	

61143

SEXTAVADO 4mm (5/32"-C4)

BIT'S 4mm (5/32" C) PARA MICROPARAFUSOS SEXTAVADOS
4mm (5/32" C) BITS FOR HEXAGON MICRO-SCREWS

58/60 HRC

EASYPACK | caixa PVC com Euro-hole #PVC bags with Euro-hole

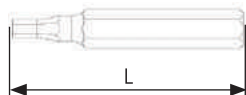

	L mm	UN.	CÓD.	€ box
0,7	28	5	61143005005	
0,9	28	5	61143010005	
1,3	28	5	61143015005	



61144 FENDA 4mm (5/32"-C4)

BIT'S 4mm (5/32" C) PARA MICROPARAFUSOS DE FENDA
4mm (5/32" C) BITS FOR SLOTTED MICRO-SCREWS

58/60 HRC

EASYPACK | caixa PVC com Euro-hole PVC bags with Euro-hole

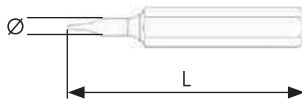

Ø mm	L mm	UN.	CÓD.	€ box
0,3	1,5	28	5	61144005005
0,37	1,8	28	5	61144010005
0,4	2	28	5	61144015005
0,4	2,5	28	5	61144020005

61146 PENTALOBE 4mm (5/32"-C4)

BIT'S 4mm (5/32" C) PARA MICROPARAFUSOS PENTALOBE
4mm (5/32" C) BITS FOR 5-LOBED MICRO-SCREWS

58/60 HRC

EASYPACK | caixa PVC com Euro-hole PVC bags with Euro-hole

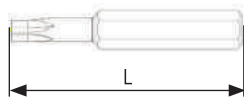

	L mm	UN.	CÓD.	€ box
P1	28	5	61046005005	
P4	28	5	61046020005	



FOCUS ON



Os dispositivos eletrônicos estão agora nas mãos de todos e, com eles, os microparafusos estão generalizados. A prerrogativa deste tipo de parafuso é a extrema precisão.

Suitable for the production of electronic devices where micro-screws are widely used. The special feature of this type of fastener is its extreme precision.



BIT'S E CHAVES ESPECIAIS

BITS AND SPECIAL SETTERS

66015

JOGO DE BIT'S DE PRECISÃO

CONJUNTO 22 UN. BIT'S PARA MICROPARAFUSOS COM CABO E EXTENSÃO
SET OF 22 BITS FOR MICRO-SCREWS WITH HANDLE AND EXTENSION



22 un.

CÓD. **66015001**



EURO-HOLE

135 X 35 X 70 mm

INCLUÍDO / INCLUDED

CÓD. 62001015002



CÓD. 62001100



61140



PH00 1 un.	PH0 1 un.	PH0 1 un.	PH1 1 un.	PH2 1 un.
---------------	--------------	--------------	--------------	--------------

61142



TX03 1 un.	TX04 1 un.	TX05 1 un.	TX06 1 un.	TX07 1 un.	TX08 1 un.
---------------	---------------	---------------	---------------	---------------	---------------

61144



0,3x1,5 1 un.	0,37x 1,8 1 un.	0,4x2,0 1 un.	0,4x2,5 1 un.
------------------	--------------------	------------------	------------------

61143



0,7 1 un.	0,9 1 un.	1,3 1 un.
--------------	--------------	--------------

61146



P1 1 un.	P4 1 un.
-------------	-------------



FOCUS ON

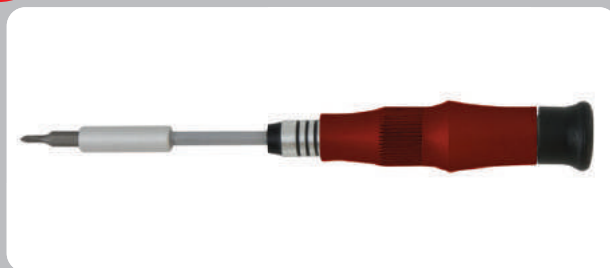

Para completar o conjunto dos perfis dos microparafusos mais utilizados, adicionamos um cabo de alumínio com um mandril rápido de elevada qualidade e uma extensão magnética.

To complete the range of tips for the most common micro-screws, we have added a practical aluminium handle with a chuck of the highest quality and a magnetic extension.

LAB TEST





62001 SUPORTE DE BIT'S 1/4"E MAGNÉTICOS

SUPORTE DE BIT'S MAGNÉTICO 1/4"E PARA BIT'S 4mm (5/32"C)
1/4"E MAGNETIC BIT-HOLDER FOR BITS 4mm (5/32"C)

EASYPACK | caixa PVC com Euro-hole #PVC bags with Euro-hole

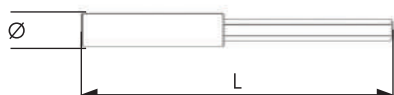

L mm	Ø mm	UN.	CÓD.	€ box
75	8,5	2	62001010002	

62001 EXTENSÕES 4mm (5/32"C)

EXTENSÃO 4mm (5/32"C) PARA BIT'S 4mm (5/32"C) COM ANEL C
4mm (5/32"C) EXTENSION FOR 4mm (5/32"C) BITS WITH C RING

EASYPACK | caixa PVC com Euro-hole #PVC bags with Euro-hole

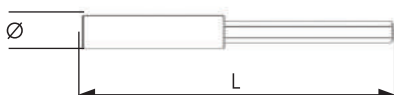

L mm	Ø mm	UN.	CÓD.	€ box
70	7,5	2	62001015002	

62001 CABOS DE PRECISÃO DE ALUMÍNIO

CABO COM BLOQUEIO PARA BIT'S 4mm (5/32"C)
HANDLE WITH LOCK FOR 4mm (5/32"C) BITS

EASYPACK | caixa PVC com Euro-hole #PVC bags with Euro-hole

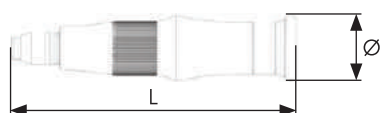

L mm	Ø mm	UN.	CÓD.	€ cad./each
90	20	1	62001100	



BIT'S E CHAVES ESPECIAIS

BITS AND SPECIAL SETTERS

61035

PH - M4

BIT'S M4 PHILLIPS® PARA APARAFUSADORAS AUTO-ALIMENTADAS
PHILLIPS® M4 BITS FOR SELF-POWERED DRIVERS

59/61 HRC

EASYPACK | caixa PVC com Euro-hole PVC bags with Euro-hole

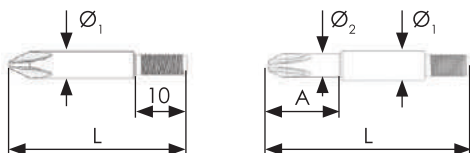

	L mm	Ø ₁ mm	Ø ₂ mmxA	UN.	CÓD.	€ box
	33	5		5	61035005005	
PH1	34	5		5	61035010005	
	45	6	5x15	5	61035015005	
PH2	34	6		5	61035020005	
	45	6		5	61035025005	

61061

PZ - M4

BIT'S M4 POZIDRIV® PARA APARAFUSADORAS AUTO-ALIMENTADAS
POZIDRIV® M4 BITS FOR SELF-POWERED DRIVERS

59/61 HRC

EASYPACK | caixa PVC com Euro-hole PVC bags with Euro-hole

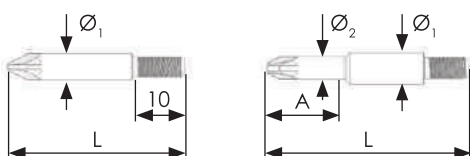

	L mm	Ø ₁ mm	Ø ₂ mmxA	UN.	CÓD.	€ box
	33	5		5	61061005005	
PZ1	34	5		5	61061010005	
	45	6	5x15	5	61061015005	
	34	6		5	61061020005	
PZ2	45	6		5	61061025005	

61091

TX - M4

BIT'S M4 PARA PARAFUSOS TORX® PARA APARAFUSADORAS
AUTO-ALIMENTADAS
M4 BITS FOR TORX® SCREWS FOR SELF-POWERED DRIVERS

59/61 HRC

EASYPACK | caixa PVC com Euro-hole PVC bags with Euro-hole

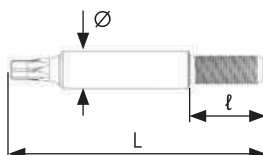

	L mm	ℓ mm	Ø mm	UN.	CÓD.	€ box
TX08	33	10	5	5	61091004005	
TX09	33	10	5	5	61091005005	
TX10	33	10	5	5	61091010005	
TX15	33	10	6	5	61091015005	
TX20	33	10	6	5	61091020005	
TX25	33	10	6	5	61091025005	



62005

SUPOORTE DE BIT'S 1/4"E PARA BIT'S M4

SUPOORTE DE BIT'S 1/4"E PARA BIT'S M4
1/4"E BIT-HOLDER FOR M4 BITS

EASYPACK | caixa PVC com Euro-hole PVC bags with Euro-hole



L mm	ℓ mm	Ø mm	UN.	CÓD.	€ box
75	15	6	2	62005005002	
100	15	6	2	62005010002	
175	15	6	2	62005015002	



FOCUS ON

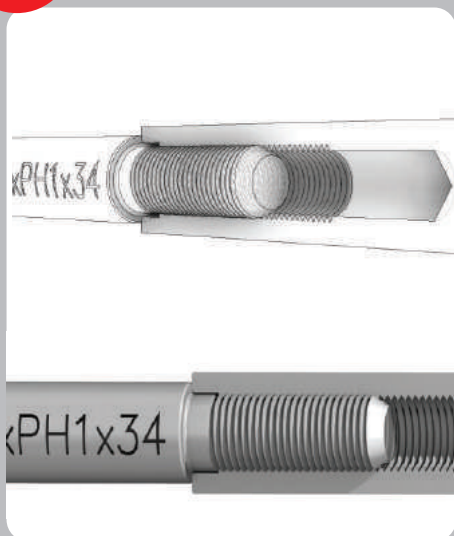

A ligação reforçada otimiza a resistência da rosca e evita a necessidade de reduzir a dureza.

O sistema ponta + suporte de Bit's é extremamente adequado para aplicações industriais com chaves de parafusos automáticas/auto-alimentadas e em instalações de aparafusamento complexas. Nestes casos, a confiabilidade do produto e a sua capacidade de resistir ao desgaste são extremamente importantes. Por estas razões, as nossas Bit's são fabricadas com tolerâncias mínimas em máquinas extremamente precisas, com o objetivo de garantir a máxima qualidade. A ligação reforçada também permite que a dureza da ponta se mantenha elevada.

Reinforced connection optimises the resistance of the thread, preventing the need to reduce the hardness.

The bit + bit-holder system is very suitable in industrial applications that use automatic/self-powered drivers and complex screwing systems. In these cases, product reliability and wear resistance are extremely important. For these reasons, our bits are manufactured with minimum tolerances on high-precision machines aimed at ensuring maximum quality. The reinforced connection also allows maintaining excellent hardness of the bit.



BIT'S E CHAVES ESPECIAIS

BITS AND SPECIAL SETTERS

61036

PH - M5

BIT'S M5 PHILLIPS® PARA APARAFUSADORAS AUTOALIMENTADAS
PHILLIPS® M5 BITS FOR SELF-POWERED DRIVERS

59/61 HRC

EASYPACK | caixa PVC com Euro-hole PVC bags with Euro-hole

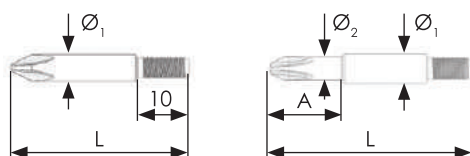

	L mm	Ø ₁ mm	Ø ₂ mmxA	UN.	CÓD.	€ box
PH1	34	6,5		5	61036005005	
	45	6	5x15	5	61036010005	
	31	7		5	61036013005	
	33	6		5	61036014005	
PH2	33	7		5	61036015005	
	34	6,5		5	61036020005	
	45	6		5	61036023005	
	45	6,5		5	61036025005	

61062

PZ - M5

BIT'S M5 POZIDRIV® PARA APARAFUSADORAS AUTO-ALIMENTADAS
POZIDRIV® M5 BITS FOR SELF-POWERED DRIVERS

59/61 HRC

EASYPACK | caixa PVC com Euro-hole PVC bags with Euro-hole

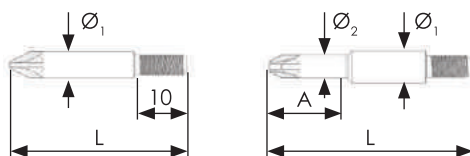

	L mm	Ø ₁ mm	Ø ₂ mmxA	UN.	CÓD.	€ box
PZ1	34	6,5		5	61062005005	
	45	6	5x15	5	61062010005	
	31	7		5	61062013005	
	33	6		5	61062014005	
PZ2	33	7		5	61062015005	
	34	6,5		5	61062020005	
	45	6		5	61062023005	
	45	6,5		5	61062025005	

61110

TXH - M5

BIT'S M5 PARA PARAFUSOS TORX® RESISTENTES À ADULTERAÇÃO PARA APARAFUSADORAS AUTO-ALIMENTADAS
M5 BITS FOR TORX® TAMPER-RESISTANT SCREWS FOR SELF-POWERED DRIVERS

59/61 HRC

EASYPACK | caixa PVC com Euro-hole PVC bags with Euro-hole

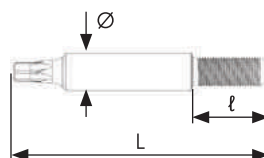

	L mm	ℓ mm	Ø mm	UN.	CÓD.	€ box
TXH15	33	10	7	5	61110005005	
TXH20	33	10	7	5	61110010005	
TXH25	33	10	7	5	61110015005	



61092 TX - M5

BIT'S M5 PARA PARAFUSOS TORX® PARA APARAFUSADORAS AUTO-ALIMENTADAS
M5 BITS FOR TORX® SCREWS FOR SELF-POWERED DRIVERS

59/61 HRC

EASYPACK | caixa PVC com Euro-hole PVC bags with Euro-hole

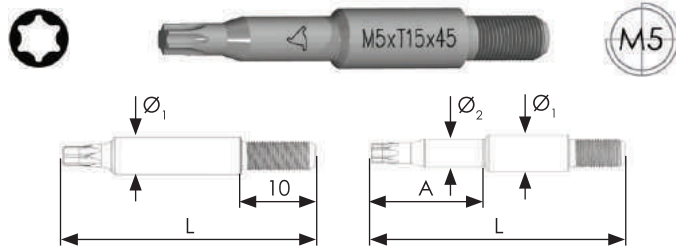

	L mm	Ø ₁ mm	Ø ₂ mmxA	UN.	CÓD.	€ box
TX10	33	6,5		5	61092002005	
	45	6		5	61092004005	
	45	6,5	5x20	5	61092005005	
TX15	33	6,5		5	61092010005	
	45	6		5	61092014005	
	45	6,5	5x20	5	61092015005	
TX20	33	6,5		5	61092020005	
	45	6		5	61092024005	
	45	6,5		5	61092025005	
TX25	33	6,5		5	61092030005	
	45	6		5	61092034005	
	45	7		5	61092035005	
TX30	33	7		5	61092037005	
	45	7		5	61092040005	
TX40	45	7		5	61092045005	

62006 SUPORTE DE BIT'S 1/4" E PARA BIT'S M5

SUPORTE DE BIT'S 1/4" E PARA BIT'S M5
1/4" E BIT-HOLDER FOR M5 BITS

EASYPACK | caixa PVC com Euro-hole PVC bags with Euro-hole

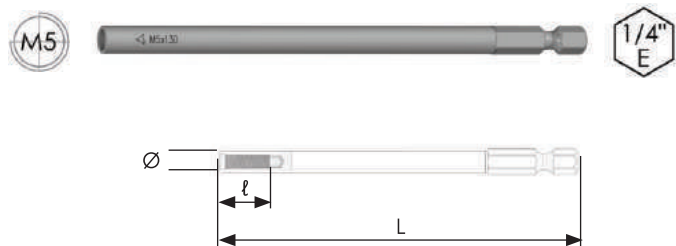

L mm	ℓ mm	Ø mm	UN.	CÓD.	€ box
85	15	7	2	62006035002	
125	15	7	2	62006010002	
130	15	7	2	62006005002	
135	15	7	2	62006040002	
150	15	7	2	62006015002	
165	15	7	2	62006045002	
175	15	7	2	62006020002	
200	15	7	2	62006025002	



BIT'S E CHAVES ESPECIAIS

BITS AND SPECIAL SETTERS

61037

PH - M6

BIT'S M6 PHILLIPS® PARA APARAFUSADORAS AUTO-ALIMENTADAS
PHILLIPS® M6 BITS FOR SELF-POWERED DRIVERS

59/61 HRC

EASYPACK | caixa PVC com Euro-hole | PVC bags with Euro-hole

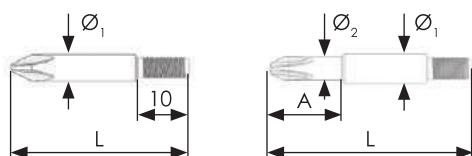

	L mm	Ø ₁ mm	Ø ₂ mmxA	UN.	CÓD.	€ box
	33	8		5	61037002005	
PH2	45	8		5	61037010005	
	44	7	5x10	5	61037005005	
PH3	34	8	7,5x18	5	61037015005	
	45	8		5	61037020005	

61063

PZ - M6

BIT'S M6 POZIDRIV® PARA APARAFUSADORAS AUTO-ALIMENTADAS
POZIDRIV® M6 BITS FOR SELF-POWERED DRIVERS

59/61 HRC

EASYPACK | caixa PVC com Euro-hole | PVC bags with Euro-hole

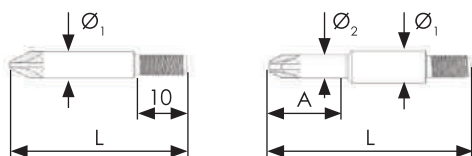

	L mm	Ø ₁ mm	Ø ₂ mmxA	UN.	CÓD.	€ box
	33	8		5	61063002005	
PZ2	45	8		5	61063005005	
	34	8,5	7,5x18	5	61063010005	
PZ3	45	8		5	61063015005	

61093

TX - M6

BIT'S M6 PARA PARAFUSOS TORX® PARA APARAFUSADORAS
AUTO-ALIMENTADAS
M6 BITS FOR TORX® SCREWS FOR SELF-POWERED DRIVERS

59/61 HRC

EASYPACK | caixa PVC com Euro-hole | PVC bags with Euro-hole

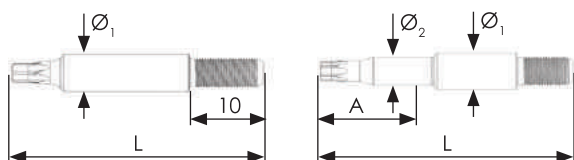

	L mm	Ø ₁ mm	Ø ₂ mmxA	UN.	CÓD.	€ box
TX15	45	8		5	61093002005	
TX20	33	8	4x16	5	61093003005	
	45	8	5x25	5	61093005005	
TX25	33	8		5	61093010005	
	45	8		5	61093012005	
TX30	33	8		5	61093014005	
	45	8		5	61093015005	
TX40	45	8		5	61093020005	



62007

SUPOORTE DE BIT'S 1/4"E PARA BIT'S M6

SUPOORTE DE BIT'S 1/4"E PARA BIT'S M6
1/4"E BIT-HOLDER FOR M6 BITS



EASYPACK | caixa PVC com Euro-hole PVC bags with Euro-hole

L mm	ℓ mm	Ø mm	UN.	CÓD.	€ box
100	15	10	2	62007005002	
165	15	8	2	62007010002	
200	15	8	2	62007015002	



FOCUS ON

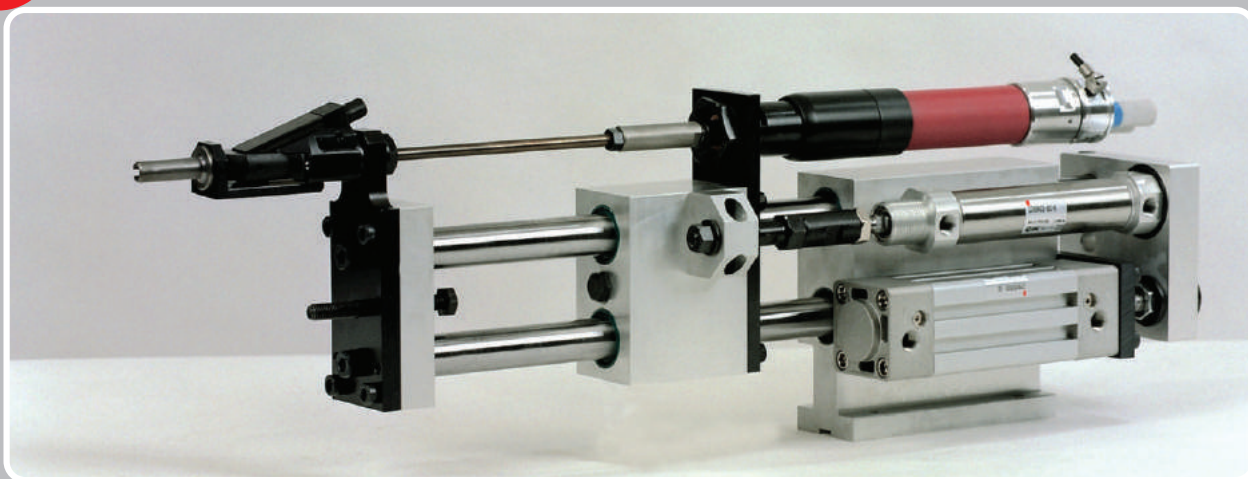

Exemplo de aparafusadora auto-alimentada com aplicação de suporte de Bit's e ponta roscadas (cortesia da MTA TECH S.r.l.)
Example of self-powered screwdriver with application of bit holder and threaded insert (by kind permission of MTA TECH S.r.l.)

Os nossos suportes de Bit's roscadas são realizados com o mesmo aço de alta qualidade que utilizamos nas Bit's. O tratamento térmico é calibrado para obter o melhor equilíbrio entre dureza e resistência também neste caso. Como fase final do processamento, antes do armazenamento, é verificada a linearidade destes produtos e, se necessário, é realizada uma operação de endireitamento para assegurar uma concentricidade não inferior a 0,1 mm.

Our threaded bit holders are made with the same high-quality steel used for the bits. The heat treatment is calibrated to obtain the best balance between hardness and toughness. As a final machining phase before storage, the straightness of these products is checked and if necessary, they are straightened to ensure concentricity of not less than 0.1 mm.



BIT'S E CHAVES ESPECIAIS

BITS AND SPECIAL SETTERS

61039

PH - UNF 10x32

BIT'S UNF 10x32 PHILLIPS® PARA APARAFUSADORAS AUTO-ALIMENTADAS
PHILLIPS® UNF 10x32 BITS FOR SELF-POWERED DRIVERS

59/61 HRC

EASYPACK | caixa PVC com Euro-hole | PVC bags with Euro-hole

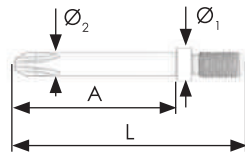

+	L mm	Ø ₁ mm	Ø ₂ mmxA	UN.	CÓD.	€ box
PH1	45	6,5	4,5x32	5	61039005005	
PH2	45	6,5	4,5x32	5	61039010005	

61065

PZ - UNF 10x32

BIT'S UNF 10x32 POZIDRIV® PARA APARAFUSADORAS AUTO-ALIMENTADAS
POZIDRIV® UNF 10x32 BITS FOR SELF-POWERED DRIVERS

59/61 HRC

EASYPACK | caixa PVC com Euro-hole | PVC bags with Euro-hole

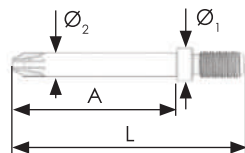

+	L mm	Ø ₁ mm	Ø ₂ mmxA	UN.	CÓD.	€ box
PZ1	45	6,5	4,5x32	5	61065005005	
PZ2	45	6,5	4,5x32	5	61065010005	

61090

TX - UNF 10x32

BIT'S UNF 10x32 PARA PARAFUSOS TORX® PARA APARAFUSADORAS AUTO-ALIMENTADAS
UNF 10x32 BITS FOR TORX® SCREWS FOR SELF-POWERED DRIVERS

59/61 HRC

EASYPACK | caixa PVC com Euro-hole | PVC bags with Euro-hole

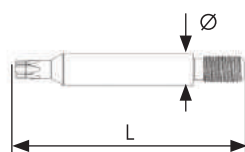

+	L mm	Ø mm	UN.	CÓD.	€ box
TX10	45	6	5	61090005005	
TX15	45	6	5	61090010005	
TX20	45	6	5	61090015005	
TX25	45	6	5	61090020005	
TX30	45	6	5	61090025005	



62009

SUPOORTE DE BIT'S 1/4"E PER BIT'S UNF 10x32

SUPOORTE DE BIT'S 1/4"E PARA BIT'S UNF 10x32
1/4"E BIT-HOLDER FOR UNF 10x32 BITS

EASYPACK | caixa PVC com Euro-hole PVC bags with Euro-hole



L mm	ℓ mm	Ø mm	UN.	CÓD.	€ box
100	15	7	2	62009005002	
117	15	7	2	62009010002	
175	15	7	2	62009015002	



FOCUS ON



Versão específica para máquinas de montagem de ferragens (mediante pedido).

Specific version for assembly machines.

Exemplo de uma aparafusadora auto-alimentada com aplicação de suporte de Bit's e ponta rosçados (cortesia da MTA TECH S.r.l.).
Example of self-powered screwdriver with application of bit holder and threaded insert (by kind permission of MTA TECH S.r.l.).



Veja o vídeo do nosso departamento de produção!

Watch the video of our production department!



Solicite um orçamento - *Get a quote*

Bit's especiais - *special bits*

até 400mm de comprimento - *length up to 400mm*

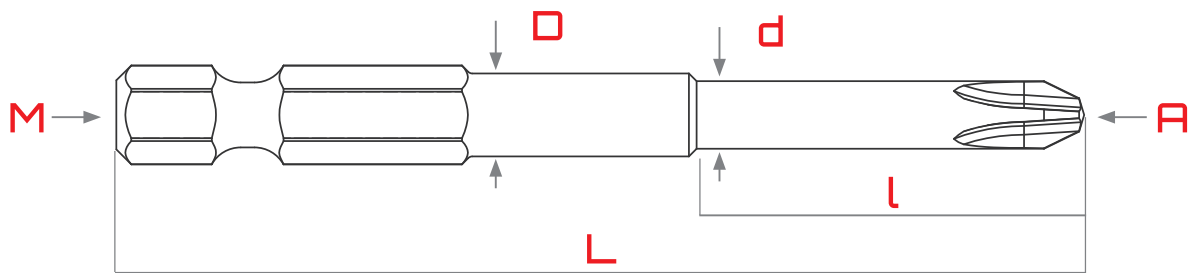

Quantidade/Quantity:

A· Ponta/Tip

- | | |
|---|-------------------------------------|
| <input type="checkbox"/> Fenda | <input type="checkbox"/> TXH |
| <input type="checkbox"/> PH | <input type="checkbox"/> IP |
| <input type="checkbox"/> PZ | <input type="checkbox"/> IPR |
| <input type="checkbox"/> Sextavada
Hexagon | <input type="checkbox"/> outro/more |
| <input type="checkbox"/> TX | |

Características/Features

- D**·mm.....
- d**·mm.....
- L**·mm.....
- L**·mm.....

M· Engate/Drive

- | | | | |
|--|---|--|--|
| <input type="checkbox"/> C (6,3mm) | <input type="checkbox"/> A (3mm) | <input type="checkbox"/> E (8mm) | <input type="checkbox"/> CAVILHA |
| <input type="checkbox"/> E (6,3mm) | <input type="checkbox"/> C (8mm) | <input type="checkbox"/> E (11,2mm) | <input type="checkbox"/> A (5,5mm) |
| <input type="checkbox"/> E (5mm)
JAPA | <input type="checkbox"/> E (5mm)
WEBER | <input type="checkbox"/> (4mm)
HALF MOO | <input type="checkbox"/> HIOS (4mm) |
| | | | <input type="checkbox"/> outro/more: |

Especificações adicionais/Further specifications:

.....

.....

.....





 Veja o vídeo do nosso departamento de produção!
 Watch the video of our production department!



Solicite um orçamento - *Get a quote*



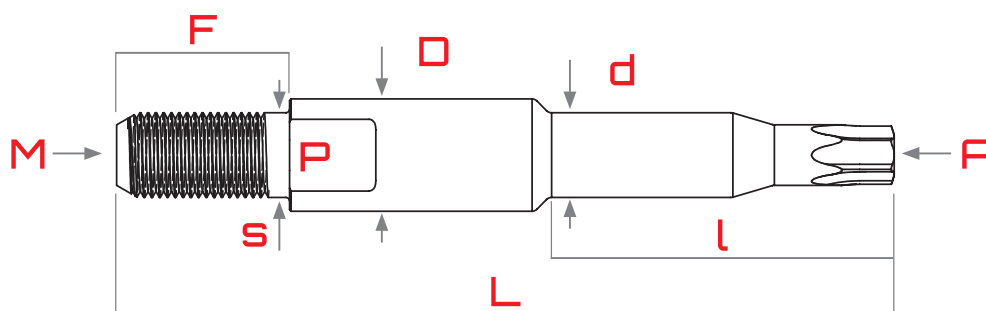





Bit's roscadas - *thread bits*

até 400mm de comprimento - *length up to 400mm*



Quantidade/Quantity:

A · Ponta/Tip

- | | | |
|---|--|--|
| <input type="checkbox"/>  Fenda/Slot | <input type="checkbox"/>  Sextavada/Hexagon | <input type="checkbox"/>  IP |
| <input type="checkbox"/>  PH | <input type="checkbox"/>  TX | <input type="checkbox"/>  IPR |
| <input type="checkbox"/>  PZ | <input type="checkbox"/>  TXH | <input type="checkbox"/> outro/more |

M · Engate/Drive

- Metric: mm
 UF: mm
 Withworth: mm
 outro: mm

Características/Features

- F** · mm **l** · mm
D · mm **P** · ives/ Levels:
d · mm mm
L · mm **S** · mm

Especificações adicionais/Further specifications:

.....

.....

.....

